

Z313 SPEAKER SYSTEM WITH SUBWOOFER

Complete Setup Guide
完整设置指南

完整設定指南
설치 가이드

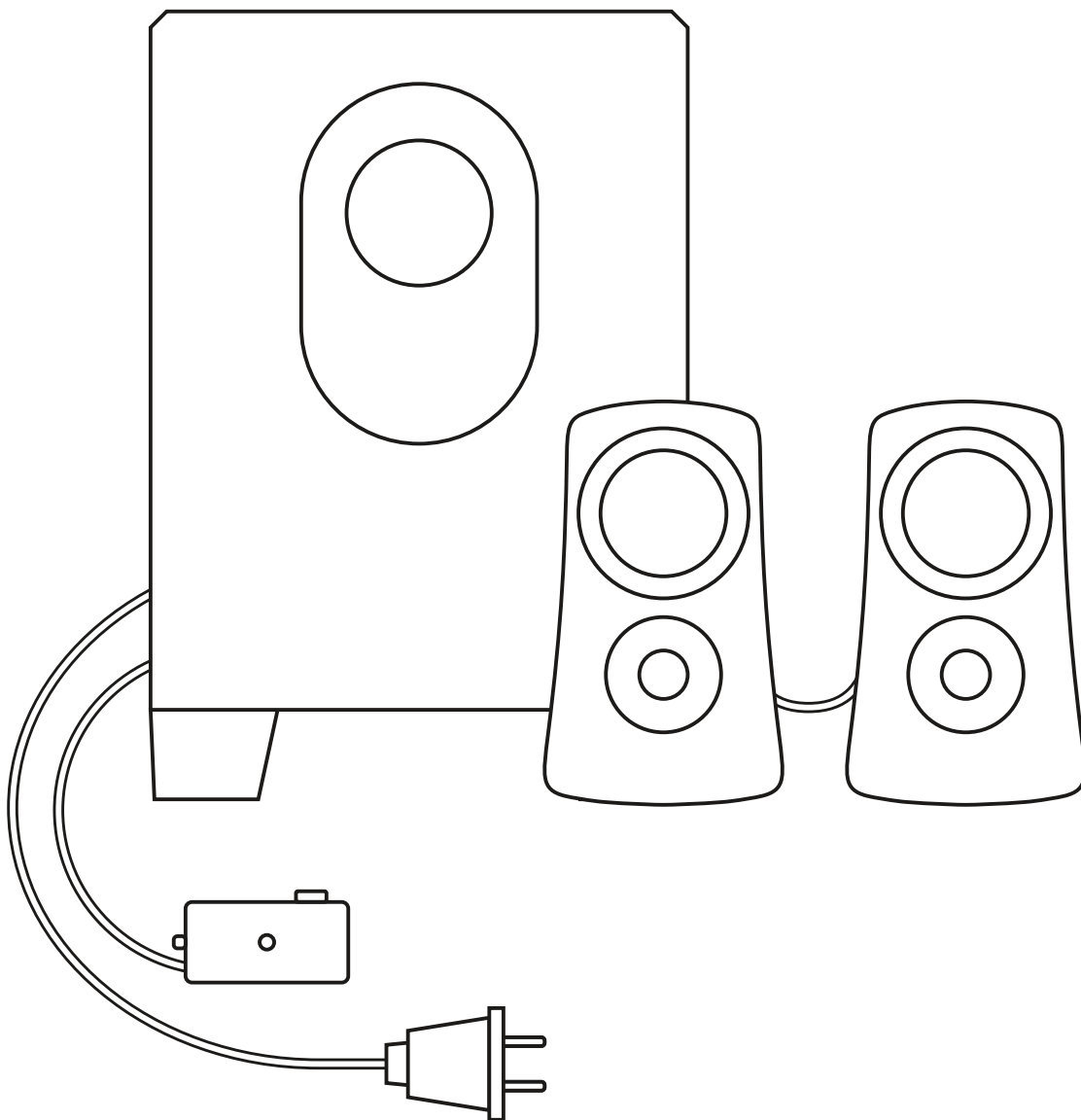

logitech®

CONTENTS

English3

简体中文6

繁體中文9

한국어12

KNOW YOUR PRODUCT

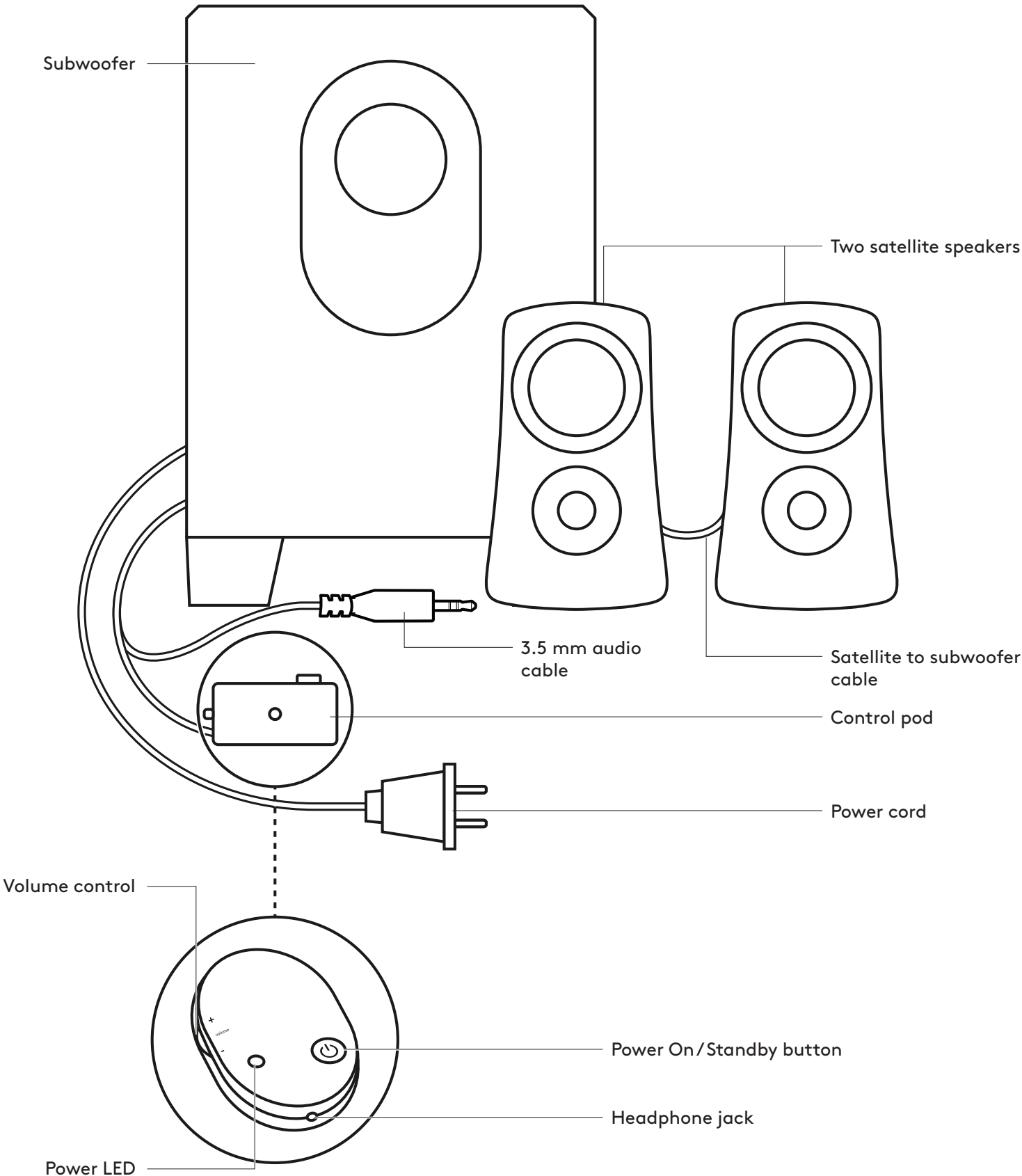

CONNECT THE SPEAKERS

1. Plug satellites cable into the subwoofer jack.
2. Plug the power plug into an electrical outlet.
3. Insert the 3.5mm connector from the control pad into the audio jack on your device (e.g. computer).
4. Press the power button on the control pod to turn the speakers on.

1

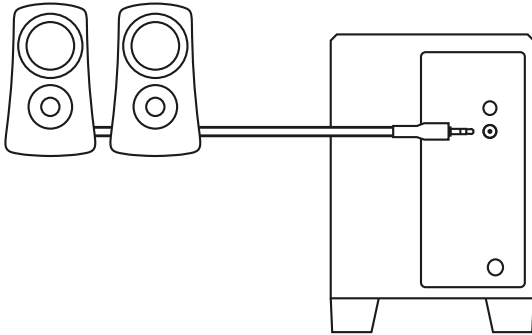

2

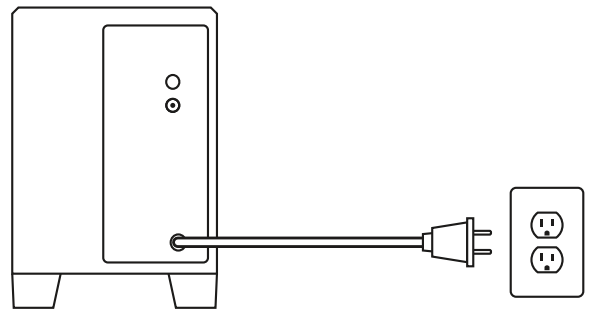

3

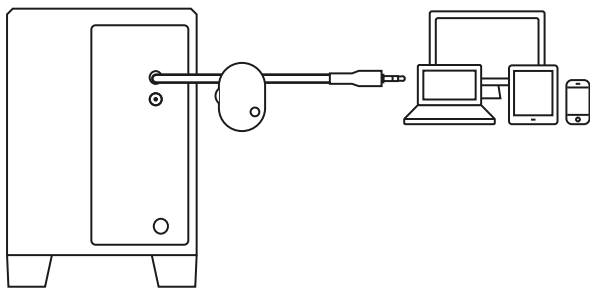

4

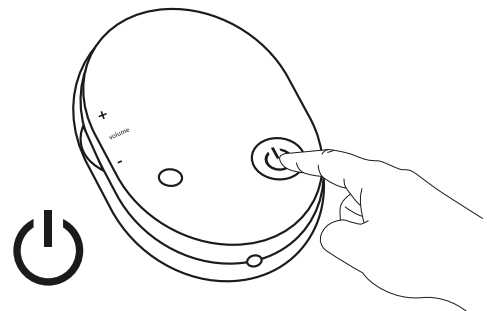

CONNECT YOUR HEADPHONES

To use headphones with your Z313 speakers, plug them into the headphone jack on the control pod.

To change the volume of your headphones, adjust the volume from your audio input source.

NOTE: The volume control on the control pod does not control the headphone volume

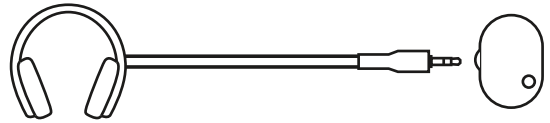

ADJUST THE VOLUME

Increase (or decrease) the speakers volume by rolling up (or down) the wheel located on the left side of the control pod.

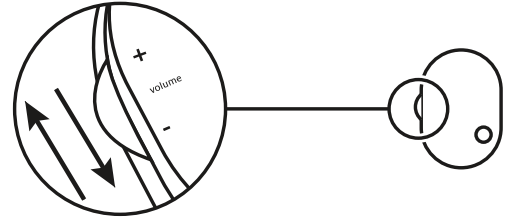

www.logitech.com/support/Z313

了解您的产品

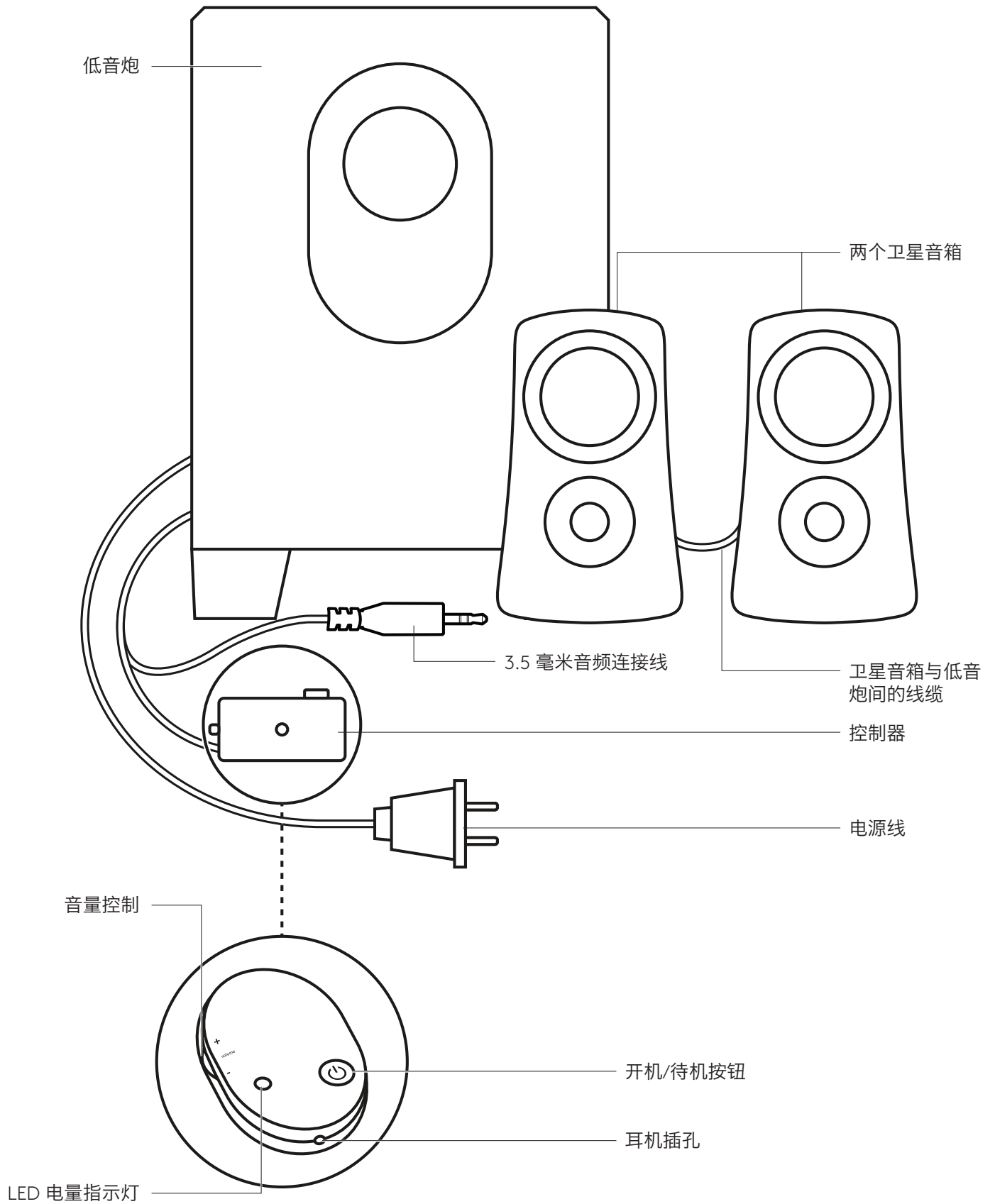

连接音箱

1. 将卫星电缆插入低音炮插孔。
2. 将电源线插入电源插座。
3. 将控制板的 3.5 毫米接头插入设备 (如电脑) 上的音频插孔。
4. 按控制器上的电源按钮打开音箱。

1

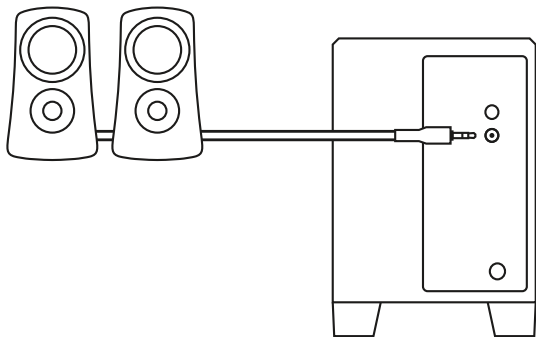

2

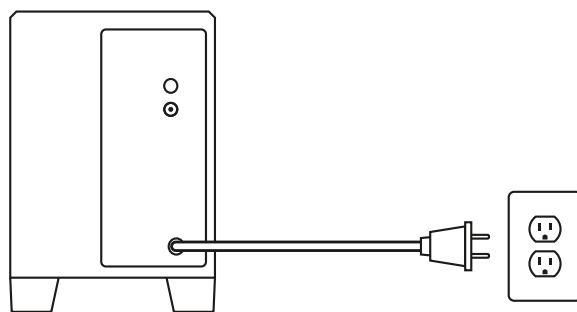

3

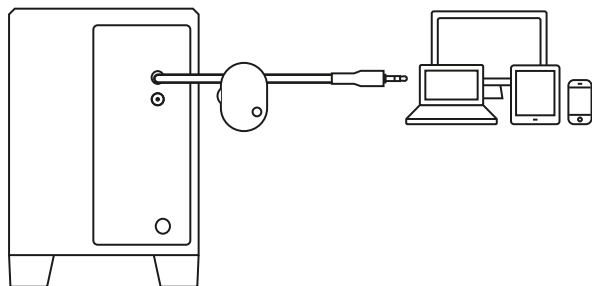

4

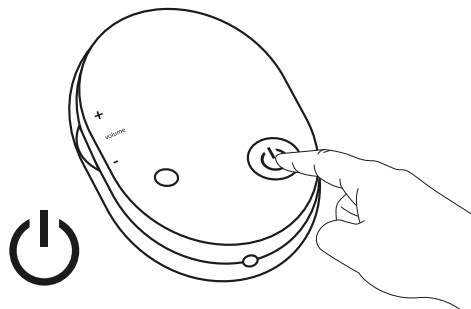

连接耳机麦克风

如要将耳机与 Z313 音箱配合使用, 请将耳机插入控制器上的耳机插孔。

要更改耳机音量, 请调整音频输入源的音量。

注: 控制器上的音量控制并不能控制耳机音量

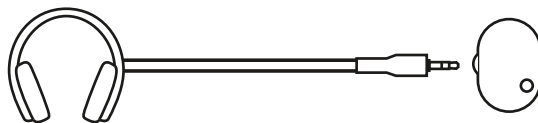

调节音量

通过向上 (或向下) 旋转位于控制器左侧的滚轮来增加 (或减小) 音箱音量。

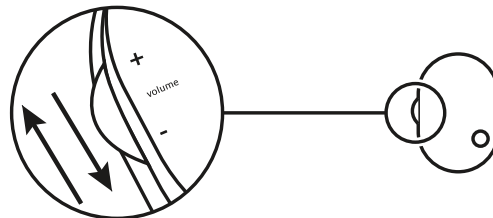

www.logitech.com/support/Z313

瞭解您的產品

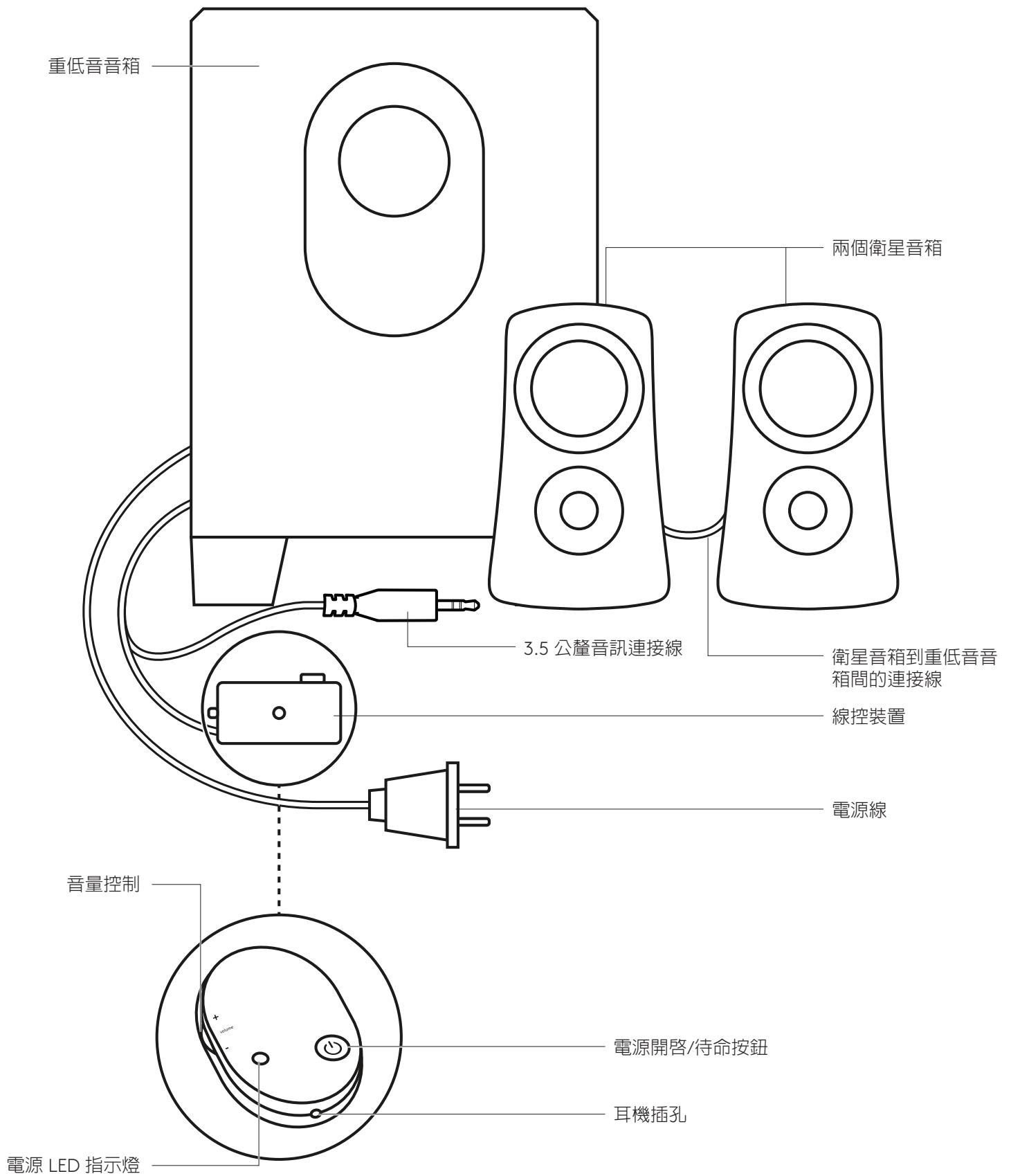

連接音箱

1. 將衛星音箱連接線插入到重低音音箱插孔。
2. 將電源插頭插入到電氣插座。
3. 將 3.5 公釐接頭從線控裝置插入到您的裝置 (例如電腦) 的音訊插孔。
4. 按下線控裝置上的電源按鈕，開啓音箱電源。

1

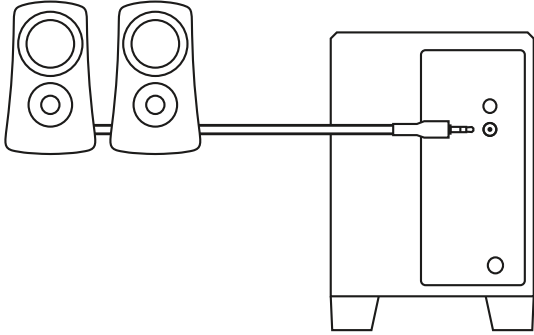

2

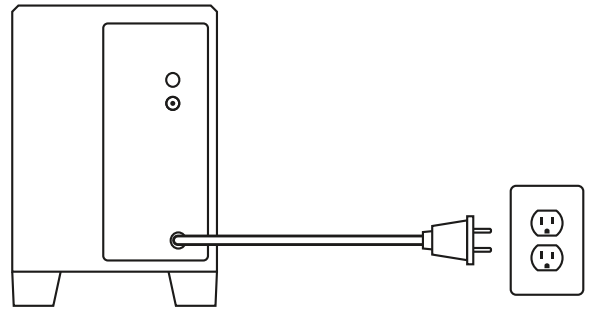

3

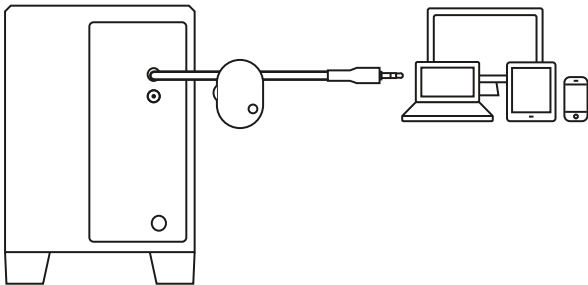

4

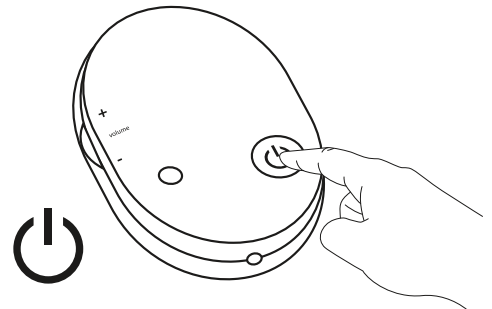

連接您的耳機

若要使用耳機搭配 Z313 音箱，請將其插入到線控裝置的耳機插孔。

若要變更耳機音量，請從音訊輸入來源調整音量。

注意：線控裝置上的音量控制按鈕無法控制耳機音量

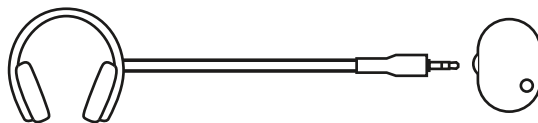

調整音量

向上 (或向下) 轉動線控裝置左側的控制轉鈕，可增加 (或減少) 音箱音量。

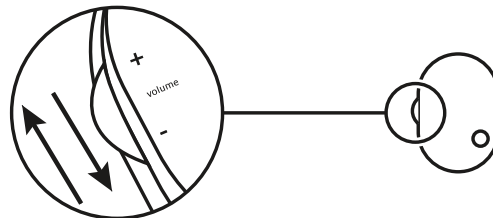

www.logitech.com/support/Z313

제품 설명

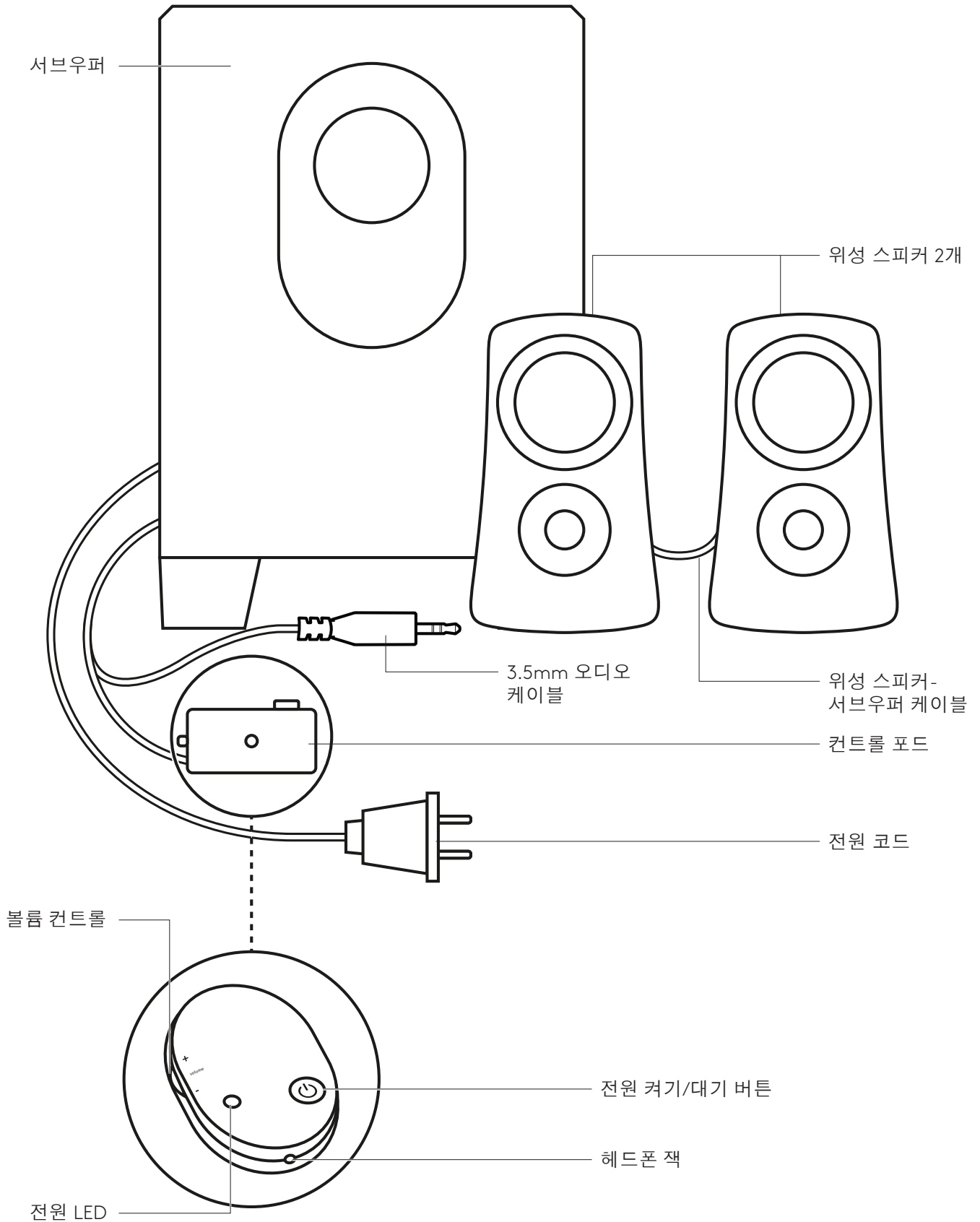

스피커 연결

1. 위성 케이블을 서브우퍼 잭에 연결합니다.
2. 전원 플러그를 전기 콘센트에 연결합니다.
3. 컨트롤 패드의 3.5mm 커넥터를 장치(예: 컴퓨터)의 오디오 잭에 연결합니다.
4. 컨트롤 포드의 전원 버튼을 눌러 스피커의 전원을 켭니다.

1

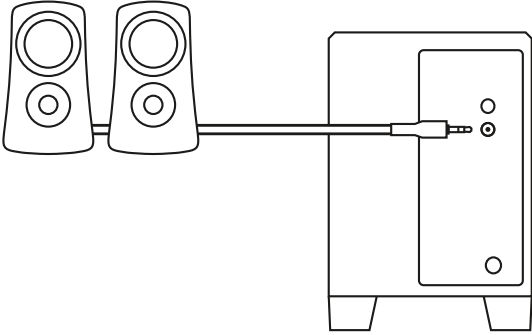

2

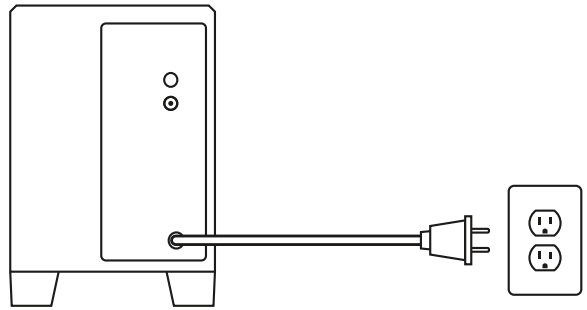

3

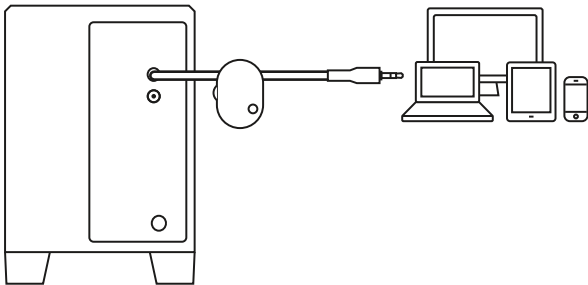

4

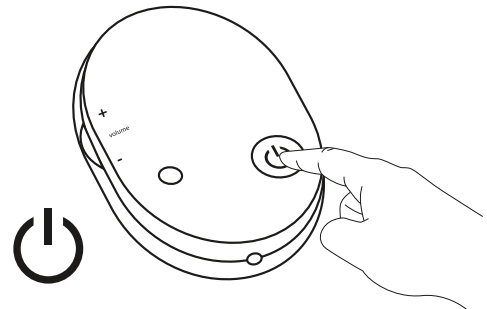

헤드폰 연결

Z313 스피커에 헤드폰을 연결하여 사용하려면 컨트롤 포드의 헤드폰 잭에 헤드폰을 연결합니다.

헤드폰의 볼륨을 조절하려면 오디오 입력 소스의 볼륨을 조절합니다.

참고: 헤드폰 볼륨은 컨트롤 포드의 볼륨 컨트롤로 조절되지 않습니다.

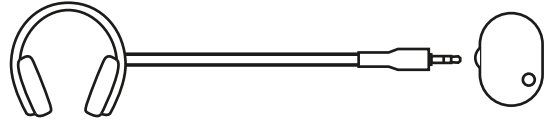

볼륨 조절

스피커의 볼륨을 올리거나 낮추려면 컨트롤 포드의 왼쪽에 있는 휠을 위 또는 아래로 돌립니다.

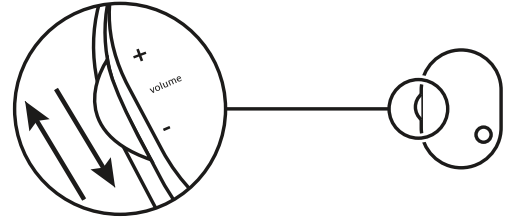

www.logitech.com/support/Z313

www.logitech.com/support/Z313

© 2019 Logitech. Logitech, Logi and other Logitech marks are owned by Logitech and may be registered. All other trademarks are the property of their respective owners. Logitech assumes no responsibility for any errors that may appear in this manual. Information contained herein is subject to change without notice.

WEB-621-001230.002

logitech®