

Z150 CLEAR STEREO SOUND

Complete Setup Guide
完整设置指南

完整設定指南
설치 가이드

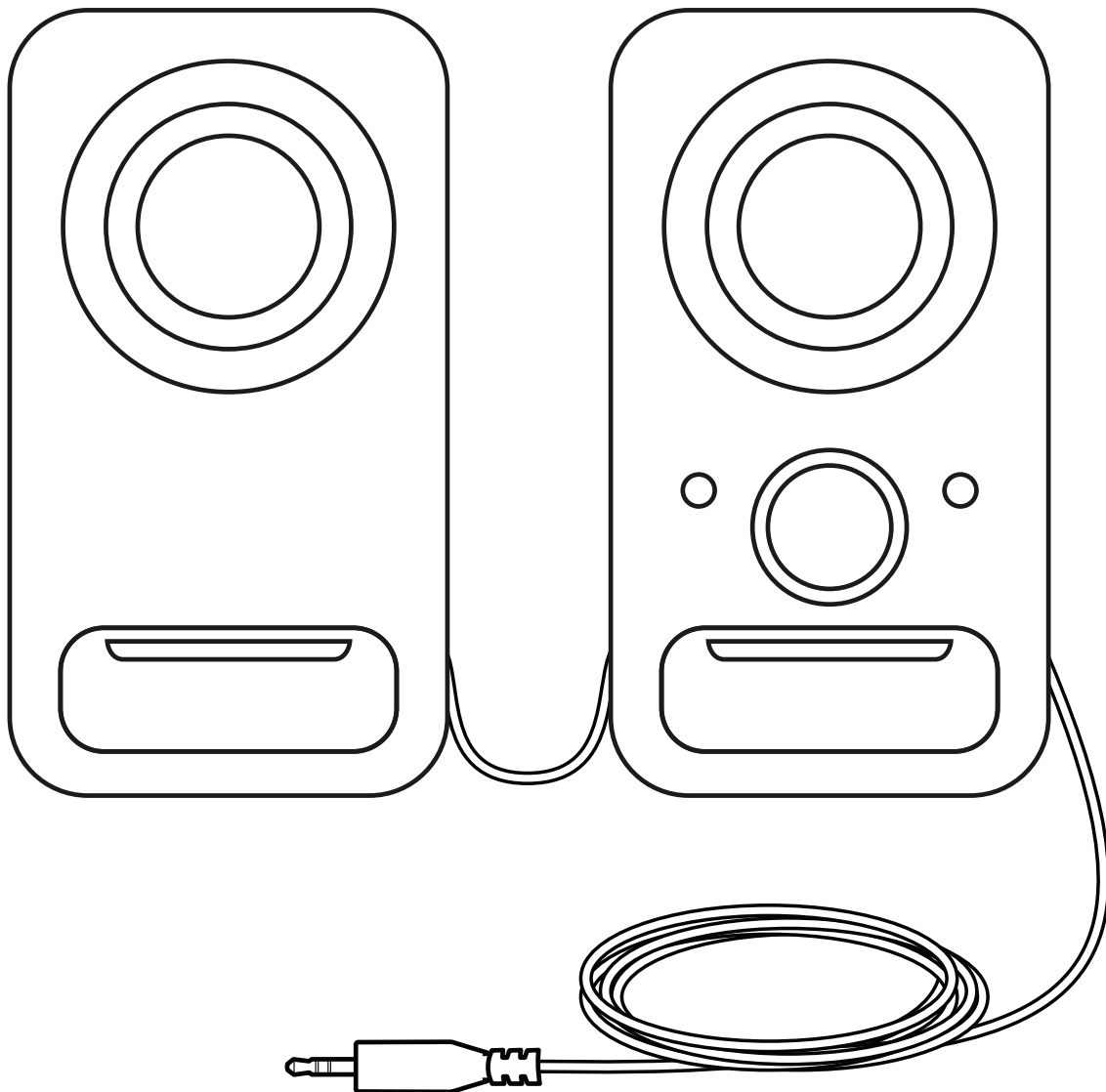

logitech®

CONTENTS

English3

简体中文6

繁體中文9

한국어12

KNOW YOUR PRODUCT

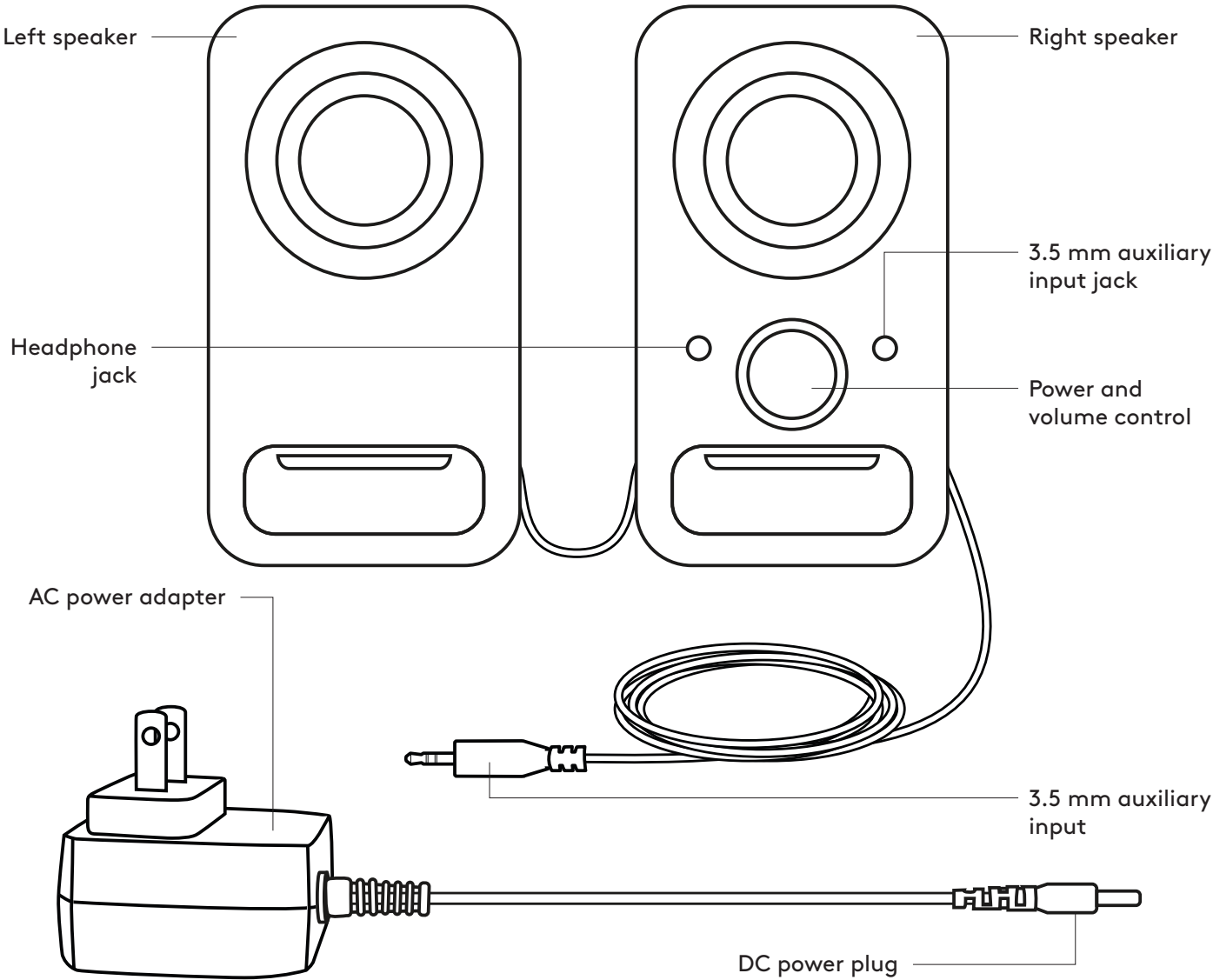

CONNECT THE SPEAKERS

1. Connect the DC power plug to the back of your right speaker and connect your AC adapter to the electrical outlet.
- 2A. Connect your source device using the attached 3.5mm auxiliary input on the right speaker.
- 2B. You can also connect a device to the auxiliary input jack on the front of the right speaker.
3. (Optional) Connect your headphones to the headphone jack on the front of the right speaker.
4. Turn the speaker on using the Power/Volume knob.

1

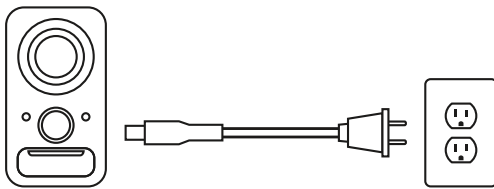

2A

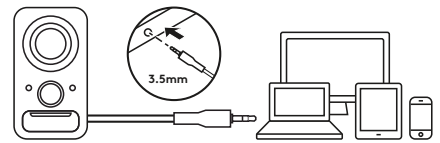

2B

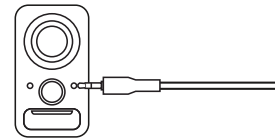

3

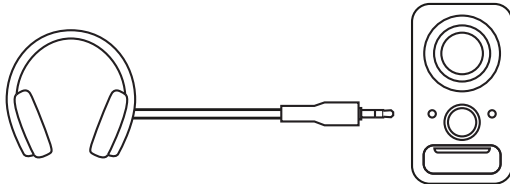

4

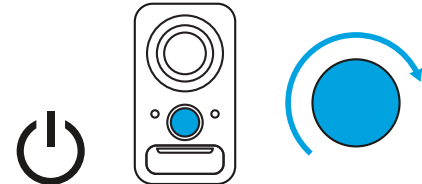

ADJUST THE VOLUME

1. Increase (or decrease) the volume of speakers by rotating the single volume control knob clockwise (or counter-clockwise) on the right speaker.

1

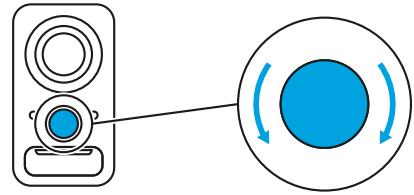

www.logitech.com/support/Z150

了解您的产品

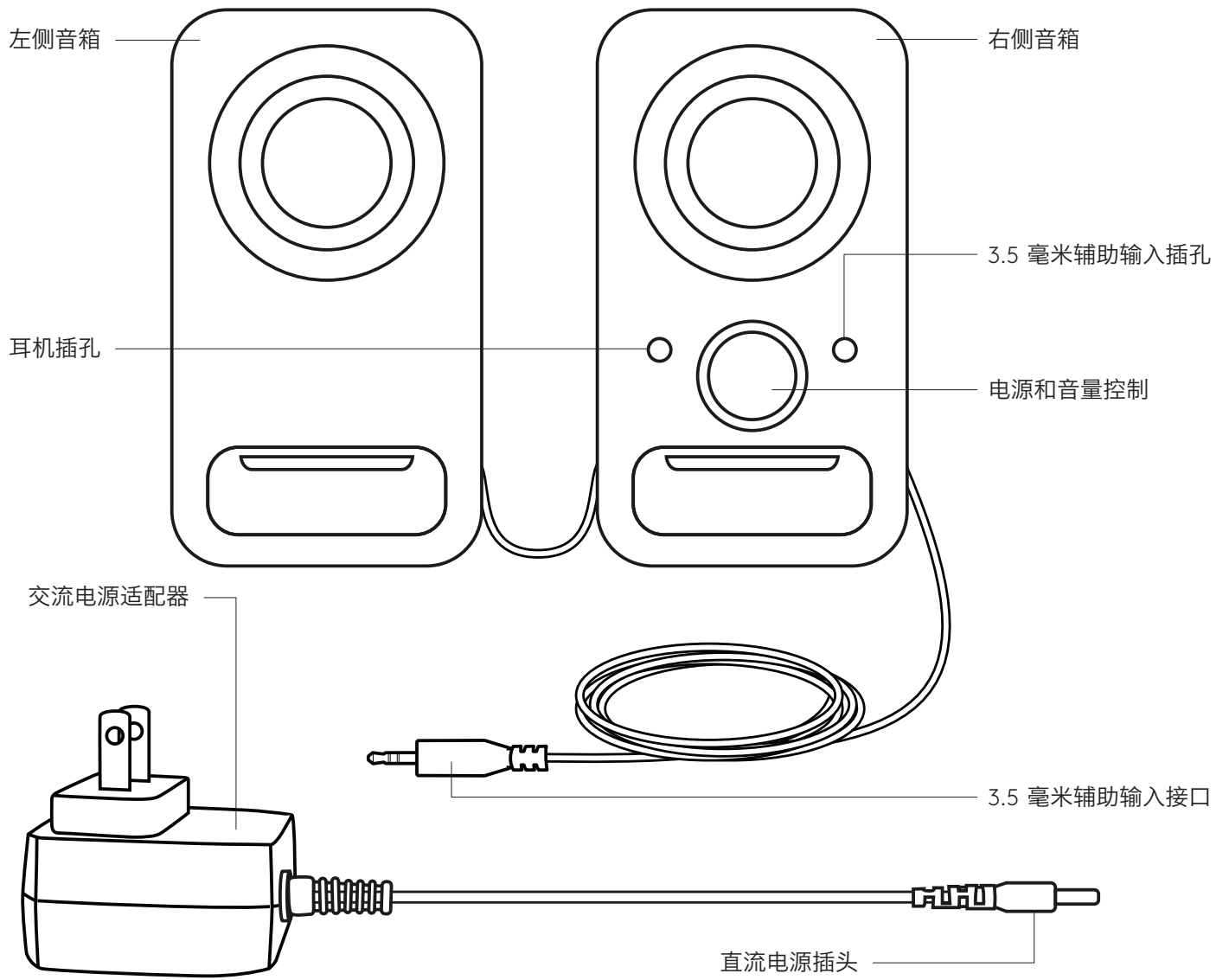

连接音箱

1. 将直流电源插头连接到右音箱背面, 然后将交流适配器连接到电源插座。
- 2A. 使用右侧音箱随附的 3.5 毫米辅助输入连接您的音源设备。
- 2B. 还可以将设备连接到右音箱正面的辅助输入插孔。
3. (可选) 将耳机连接到右音箱正面的耳机插孔。
4. 通过电源/音量旋钮开启音箱。

1

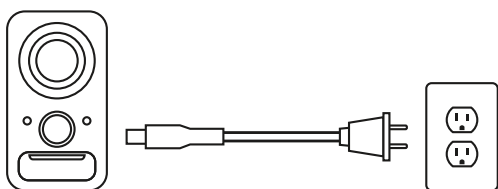

2A

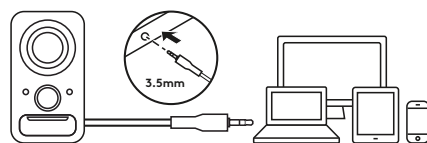

2B

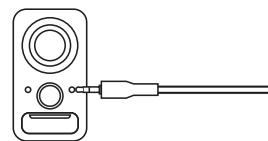

3

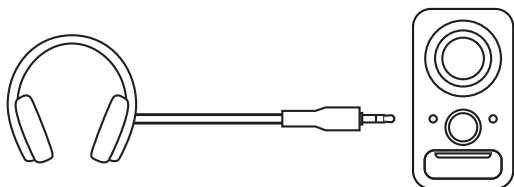

4

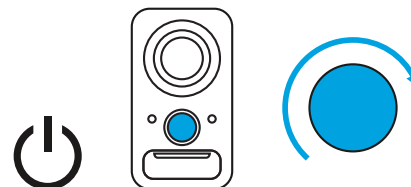

调节音量

1. 顺时针 (或逆时针) 旋转右音箱上的单音量控制旋钮, 提高 (或降低) 音箱音量。

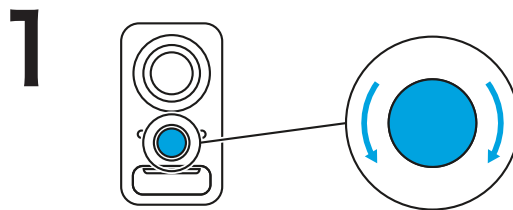

www.logitech.com/support/Z150

瞭解您的產品

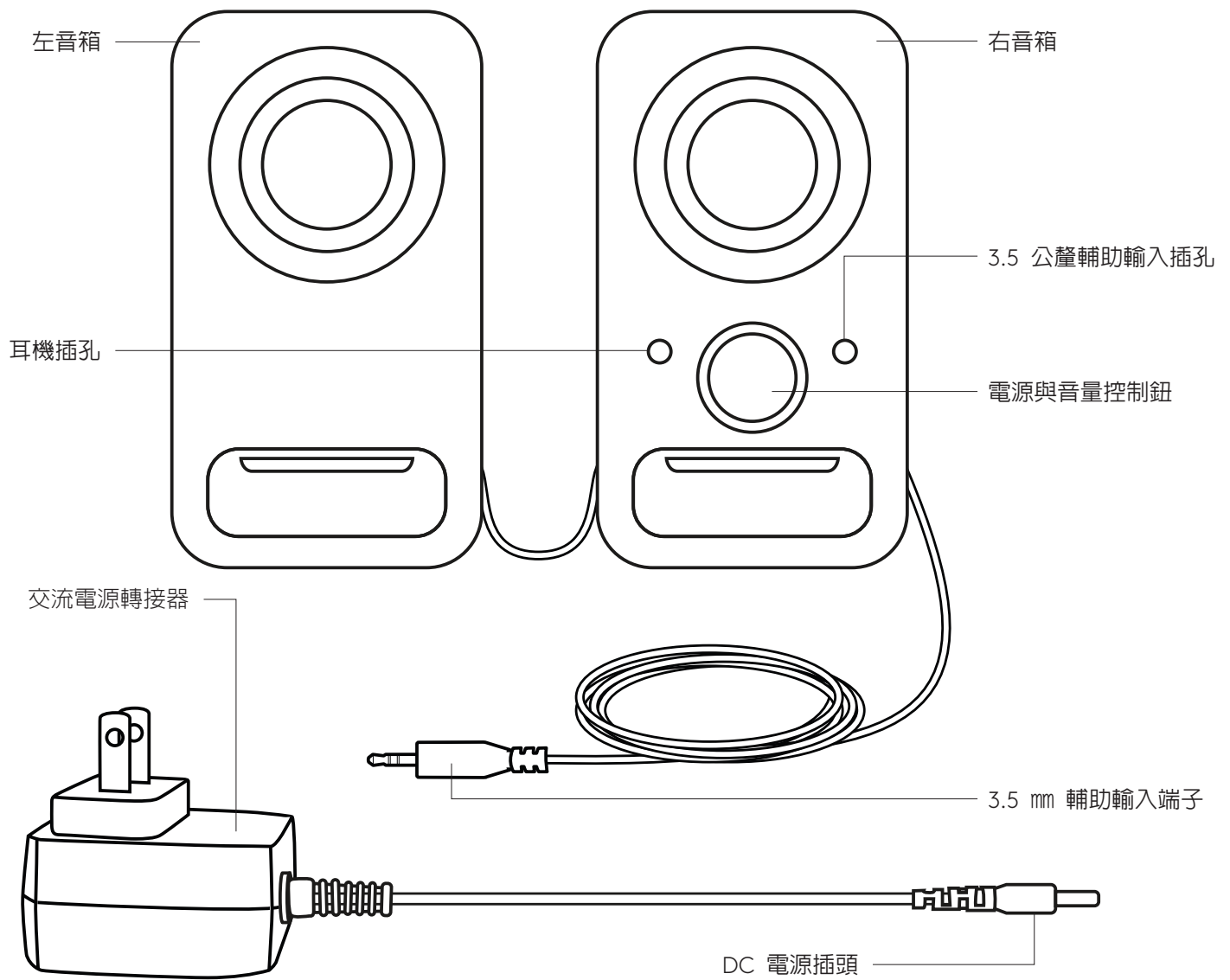

連接音箱

1. 將 DC 電源線插入右音箱背面，然後將 AC 電源轉接器連接到電氣插座。
- 2A. 使用右音箱上連接的 3.5 公釐輔助輸入埠連接聲音來源。
- 2B. 您也可以將裝置連接到右音箱正面的輔助輸入連接插孔。
3. (選用) 將您的耳機連接到右音箱正面的耳機插孔。
4. 使用電源/音量轉鈕開啓音箱電源。

1

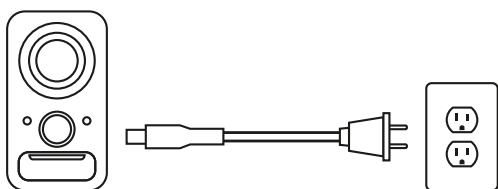

2A

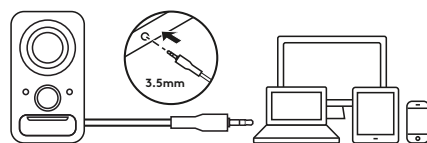

2B

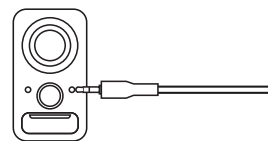

3

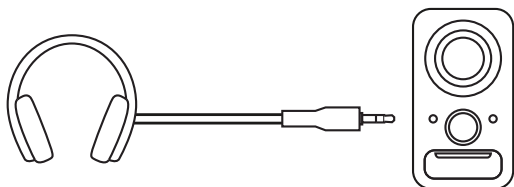

4

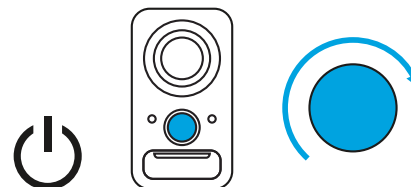

調整音量

1. 順時針 (逆時針) 旋轉右音箱上的音量控制鈕可增加 (減少) 音箱音量。

1

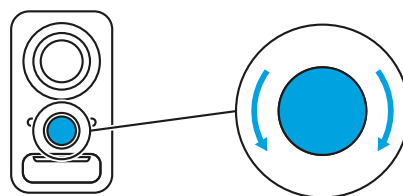

www.logitech.com/support/Z150

제품 설명

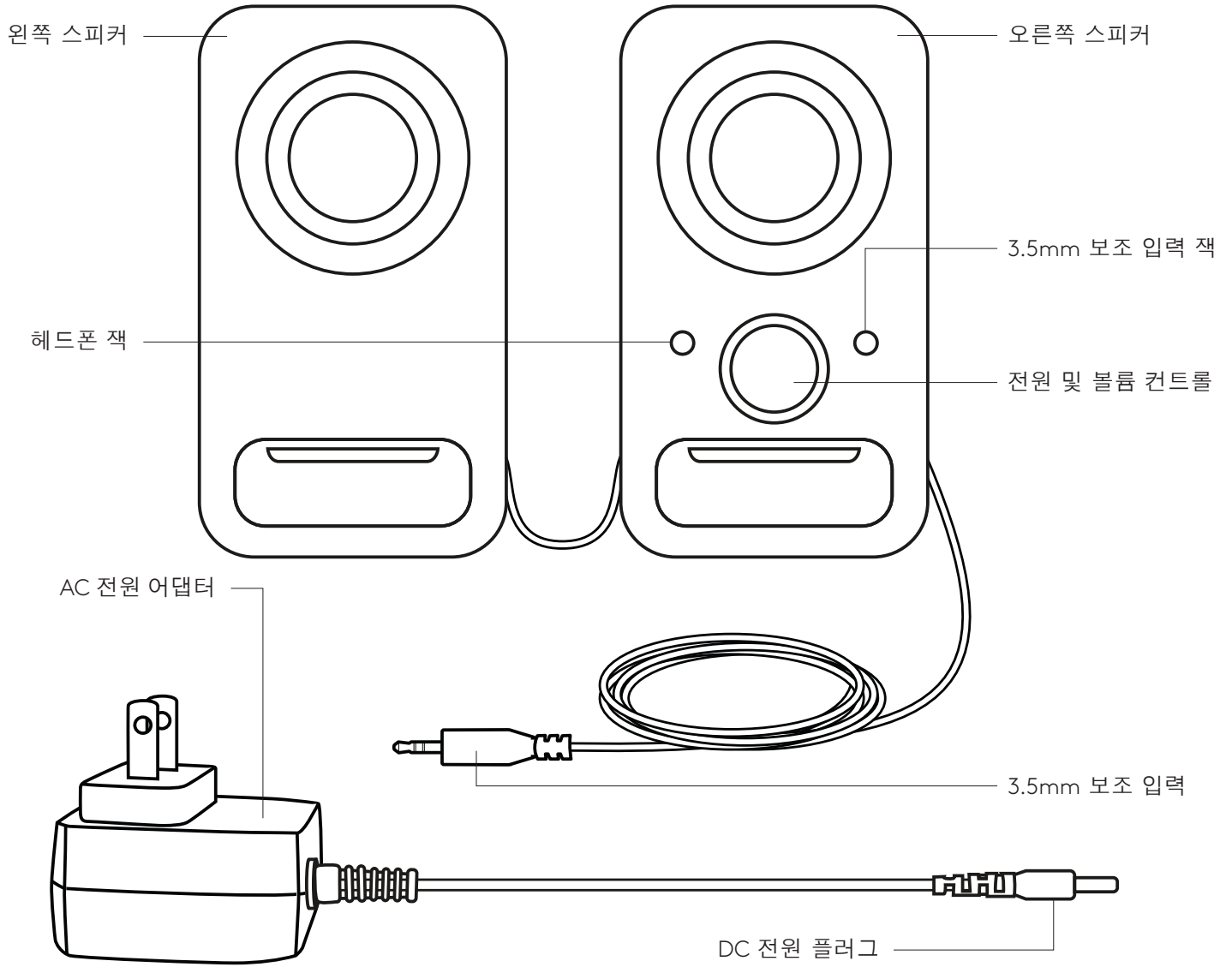

스피커 연결

1. DC 전원 플러그를 오른쪽 스피커 뒤쪽에 연결하고 AC 어댑터를 전기 콘센트에 연결하십시오.
- 2A. 오른쪽 스피커에 연결된 3.5mm 보조 입력을 사용하여 소스 장치를 연결하십시오.
- 2B. 장치를 오른쪽 스피커 전면에 있는 보조 입력 잭에 연결할 수도 있습니다.
3. 오른쪽 스피커 전면에 있는 헤드폰 잭에 헤드폰을 연결합니다(선택 사항).
4. 전원/볼륨 노브를 사용하여 스피커를 켜십시오.

1

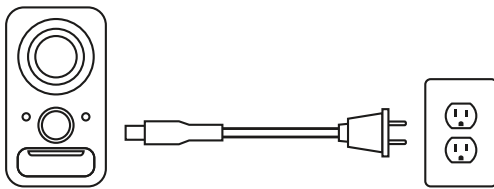

2A

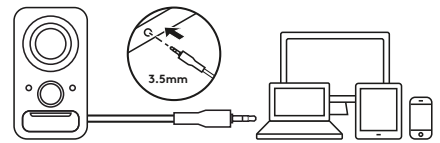

2B

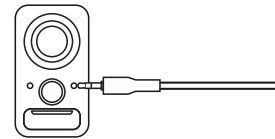

3

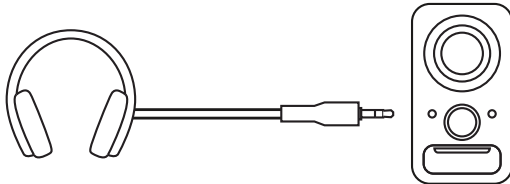

4

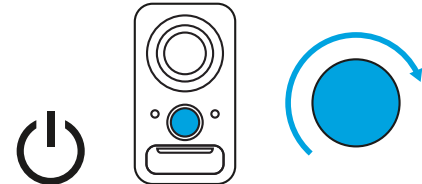

볼륨 조절

1. 오른쪽 스피커의 단일 볼륨 컨트롤 노브를 시계 방향(또는 반시계 방향)으로 돌려서 스피커 볼륨을 높이거나 낮춥니다.

1

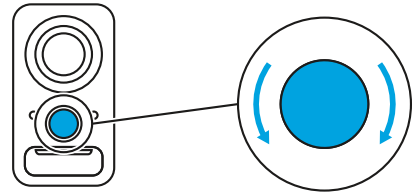

www.logitech.com/support/Z150

www.logitech.com/support/Z150

© 2019 Logitech. Logitech, Logi and other Logitech marks are owned by Logitech and may be registered. All other trademarks are the property of their respective owners. Logitech assumes no responsibility for any errors that may appear in this manual. Information contained herein is subject to change without notice.

WEB-621-001221.002

logitech®