

# LOGITECH ZONE WIRED

Setup Guide

## 罗技 ZONE 有线耳机麦克风

设置指南

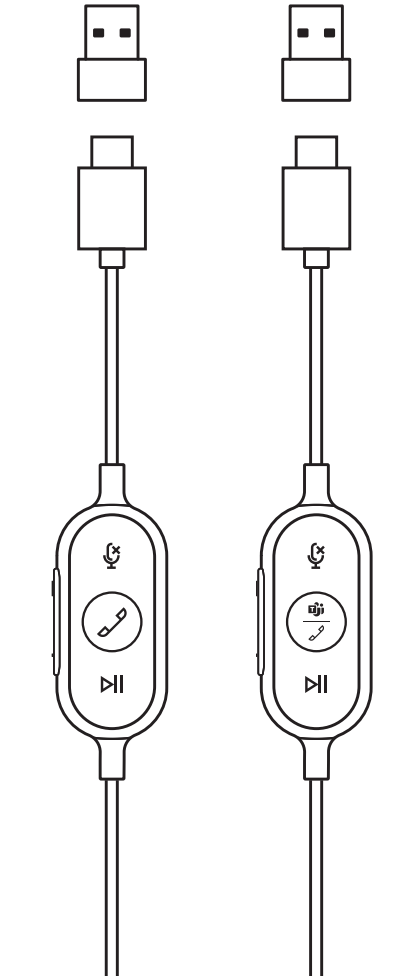

UNIFIED  
COMMUNICATIONS  
(UC) VERSION

统一通讯 (UC) 版

MICROSOFT  
TEAMS VERSION

MICROSOFT  
TEAMS 版

## CONTENTS

English . . . . . 3

简体中文 . . . . . 10

繁體中文 . . . . . 17

한국어 . . . . . 24

# KNOW YOUR PRODUCT



# IN-LINE CONTROLLER

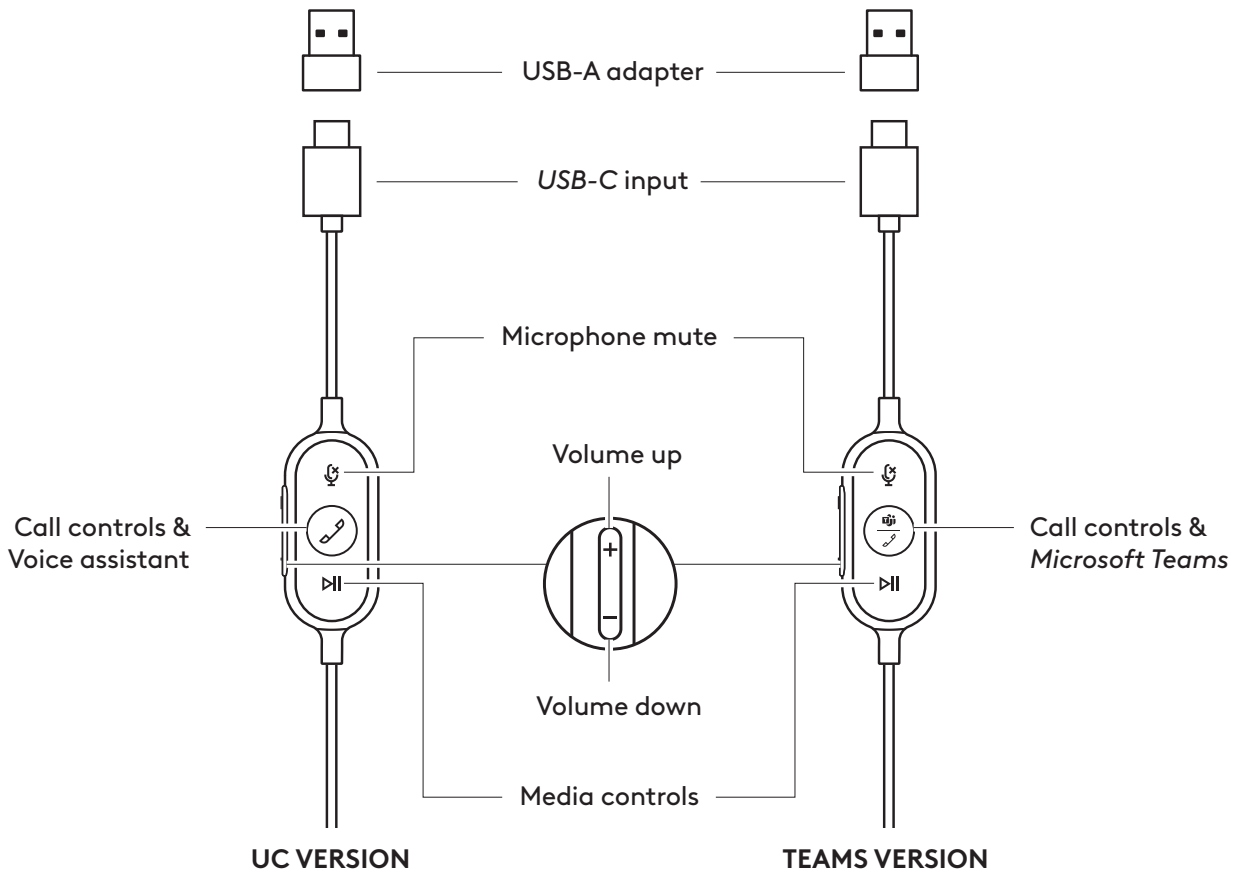

## WHAT'S IN THE BOX

1. Headset with In-line controller and *USB-C* connector
2. *USB-A* adapter
3. Travel bag
4. User documentation

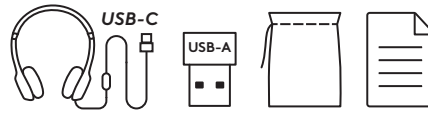

## CONNECTING THE HEADSET

### Connect via *USB-C*

1. Plug the *USB-C* connector into your computer *USB-C* port.

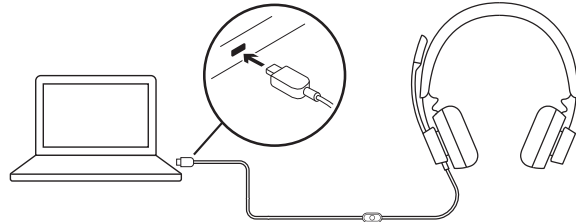

### Connect via *USB-A*

1. Plug the *USB-C* connector into the *USB-A* adapter.
2. Plug the *USB-A* connector into your computer *USB-A* port.

**Note:** Only use the *USB-A* adapter with the provided headset.

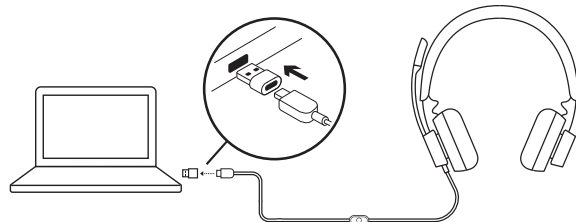

## HEADSET FIT

Adjust headset by sliding headband open or closed on both sides.

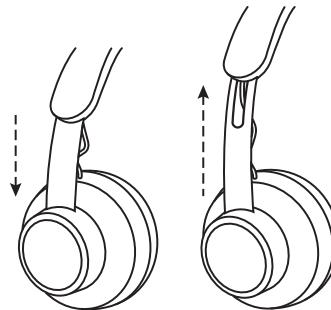

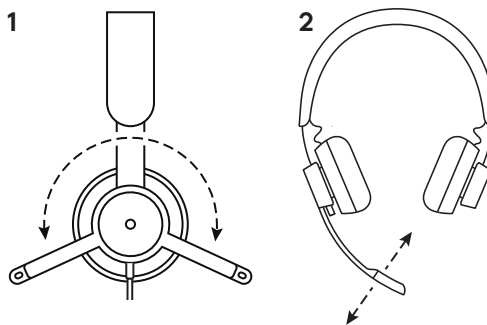

## ADJUSTING THE MICROPHONE BOOM

1. Microphone boom rotates 270 degrees. Wear it on either left or right side. For the best music experience, we recommend wearing the headset with the microphone on the left. Left/Right indicators can be found on the side of the headset.
2. Adjust flexible microphone boom location to capture voice better.





## HEADSET IN-LINE CONTROLS AND INDICATOR LIGHT

TEAMS version				
Button	Usage		Indicator Light	Action
	<b>Mute</b>	Mute on	Solid RED	Short press to Mute / Unmute
		Mute off	No light	
	<b>Call Controls</b>	Incoming calls	Flashing WHITE	Short press to Answer calls
				2 second press to Reject calls
		Ongoing calls	Solid WHITE	Short press to End calls
	<b>Teams Activities</b>	Connecting to Teams	Pulsing PURPLE	Short press to check connection to Teams
		Failed connection to Teams	Flashing PURPLE for 10 secs then off	
		Not connected to Teams	Flashing PURPLE 3 times then off	
Connected to Teams		Solid PURPLE	Short / 2 second press for Teams activities	
	Teams Missed call / Voice mail / Join meeting notifications	Pulsing PURPLE	Short press to Respond to Teams notifications	
	<b>Media Controls</b>		No light	Short press to Play / Pause
				Double press to Track forward
				Triple press to Track backward
+ -	<b>Volume</b>		No light	Short press to Volume up
				Short press to Volume down

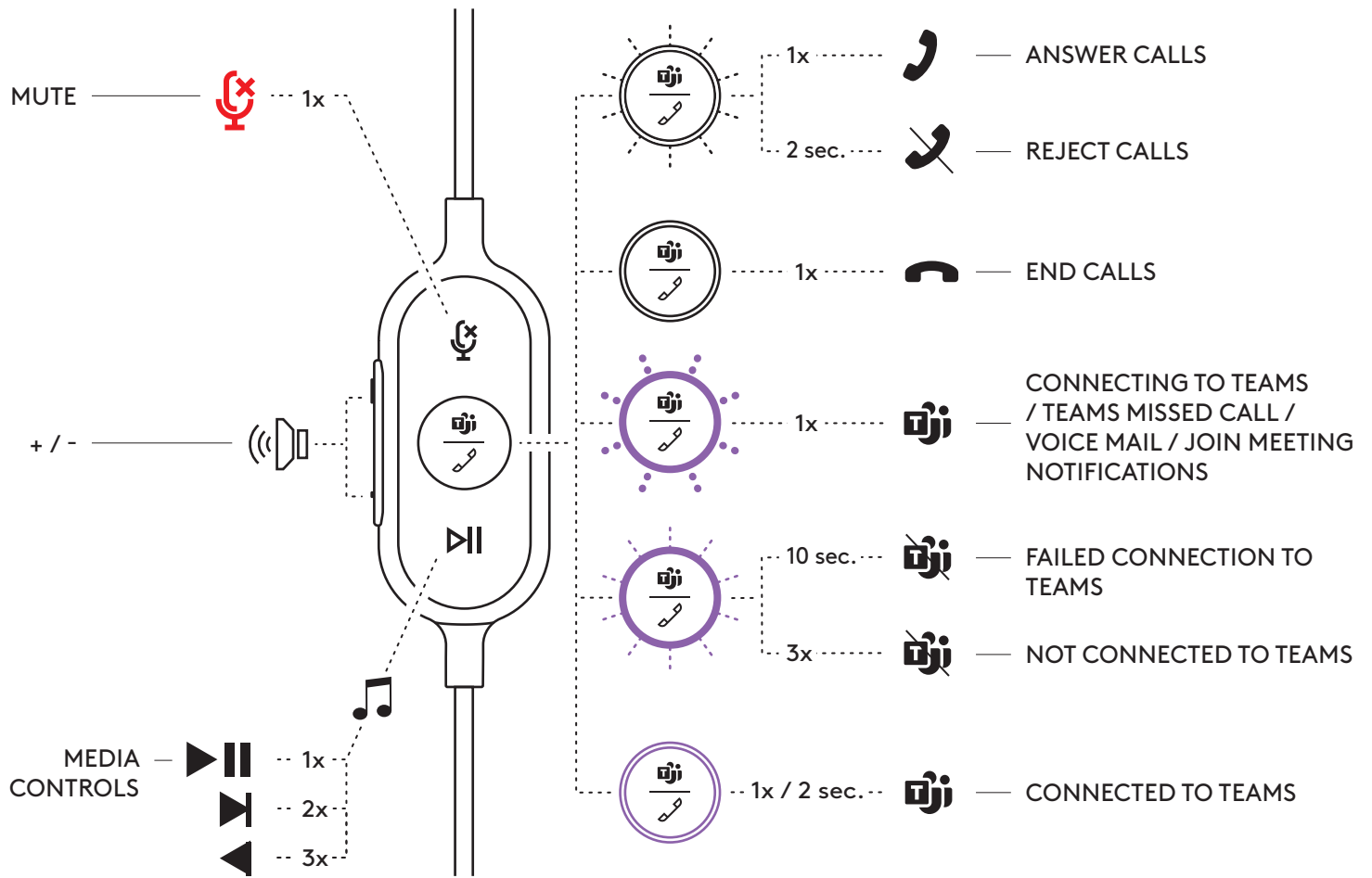
**Note:** Teams activities are only functional when Teams is running on unlocked PC or Mac.



UC version				
Button	Usage		Indicator Light	Action
	<b>Mute</b>	Mute on	Solid RED	Short press to Mute / Unmute
		Mute off	No light	
	<b>Call Controls</b>	Incoming calls	Flashing WHITE	Short press to Answer calls
		Ongoing calls	Solid WHITE	Short press to End calls
	<b>Voice Assistant</b>		No light	2 second press to Trigger voice assistant*
	<b>Media Controls</b>		No light	Short press to Play / Pause
				Double press to Track forward
				Triple press to Track backward
+	<b>Volume</b>		No light	Short press to Volume up
-		Short press to Volume down		

\*Voice assistant functionality may depend on device models.

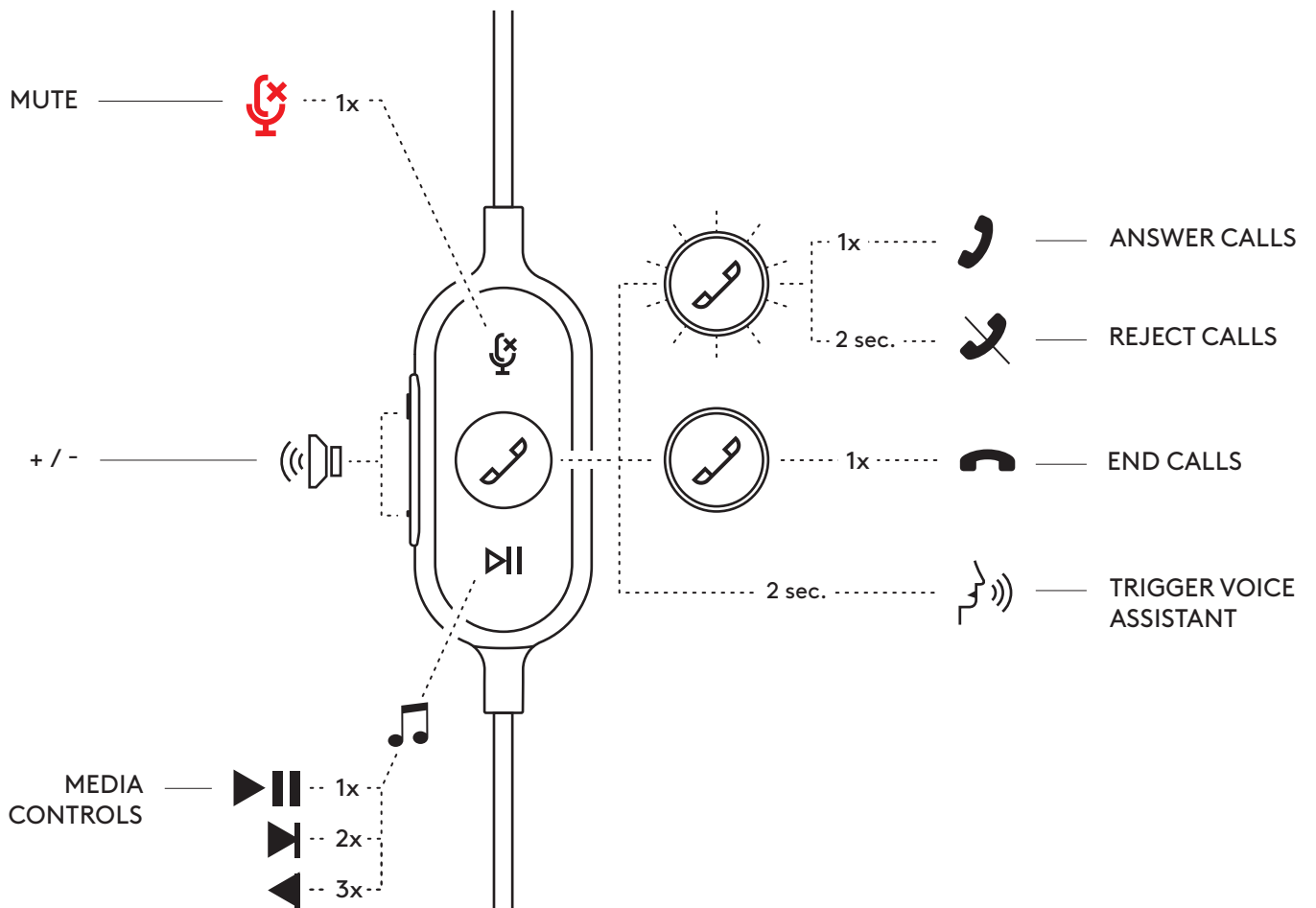

## **LOGI TUNE DESKTOP (PC COMPANION APP)**

Logi Tune Desktop helps boost your headset performance with periodic software and firmware updates, helps you adjust what you hear with 5 band EQ customization, and helps you control how you are heard with mic gain, sidetone controls, and more. The distraction-free mini-app allows you to make audio adjustments while in an active video call.

Learn more & download Logi Tune Desktop at:  
[www.logitech.com/tune](http://www.logitech.com/tune)

## **ADJUSTING SIDETONE**

Sidetone lets you hear your own voice during conversations so you are aware of how loud you are talking. In Logi Tune, select the sidetone feature, and adjust the dial accordingly.

- A higher number means you hear more external sound.
- A lower number means you hear less external sound.

## **UPDATE YOUR HEADSET**

It is recommended to update your headset. To do so, download Logi Tune from [www.logitech.com/tune](http://www.logitech.com/tune)



## **DIMENSION**

### **Headset:**

Height x Width x Depth: 165.93mm x 179.73mm x 66.77mm

Weight: 0.211 Kg

### **Ear pad dimensions:**

Height x Width x Depth: 65.84mm x 65.84mm x 18.75mm

### **Adapter:**

Height x Width x Depth: 21.5mm x 15.4mm x 7.9mm

## **SYSTEM REQUIREMENTS**

*Windows, Mac or Chrome* based computer with available *USB-C* or *USB-A* port. *USB-C* compatibility with mobile devices depends on device models.

## **TECHNICAL SPECIFICATIONS**

Input Impedance: 32 Ohms

Sensitivity (headphone): 99dB±3dB at 1000Hz @30mW,1cm

Sensitivity (microphone): Main mic: -48 dBV/Pa, Secondary mic: - 40 dBV/Pa

Frequency response (Headset): 20~16 kHz

Frequency response (Microphone): 100~16 kHz

Cable length: 1.9 m

# 了解您的产品

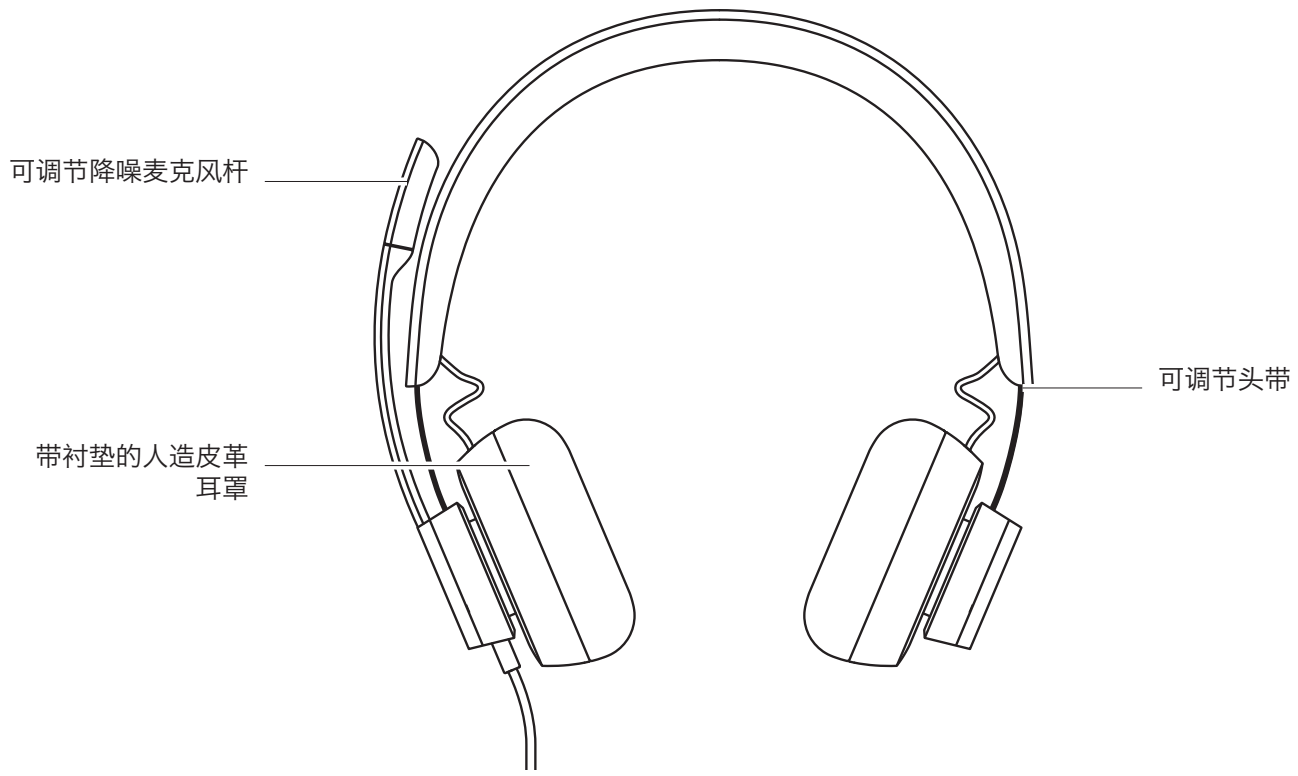

# 线控

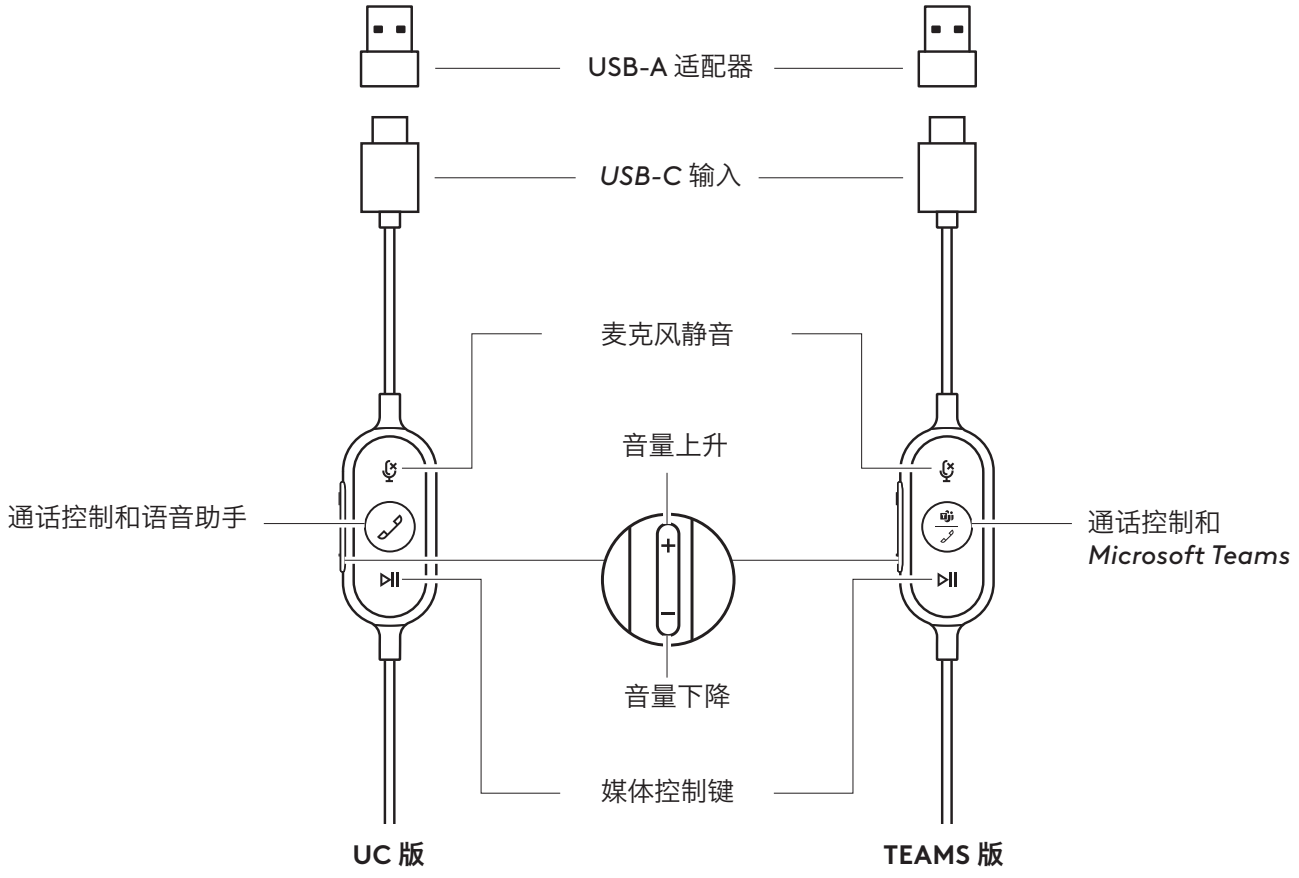

## 包装内容

1. 带线控和 **USB-C** 接头的耳机麦克风
2. **USB-A** 适配器
3. 便携包
4. 用户文档

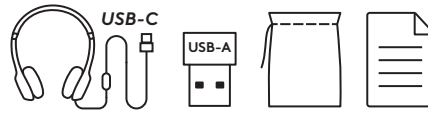

## 连接耳机麦克风

### 通过 **USB-C** 连接

1. 将 **USB-C** 接头插入电脑的 **USB-C** 端口。

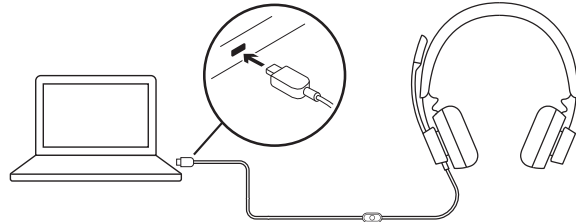

### 通过 **USB-A** 连接

1. 将 **USB-C** 接头插入 **USB-A** 适配器。
2. 将 **USB-A** 接头插入电脑的 **USB-A** 端口。

**注：** 仅可使用随附的 **USB-A** 适配器搭配耳机麦克风。

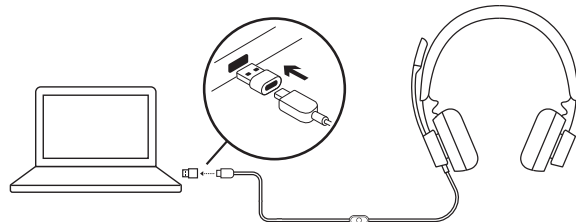

## 耳机麦克风佩戴

滑动两侧头带调节耳机麦克风。

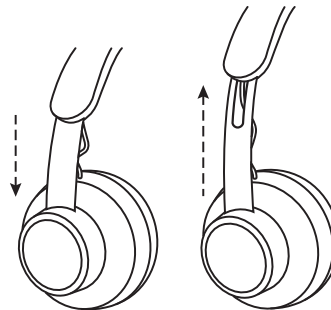

## 调节麦克风杆

1. 麦克风杆可旋转 **270** 度。可将其佩戴于左侧或右侧。  
为获得理想的音乐体验，我们建议佩戴耳机麦克风时将麦克风位于左侧。左/右指示灯位于耳机麦克风的侧面。
2. 调节灵活麦克风杆的位置，以便更好地捕捉语音。

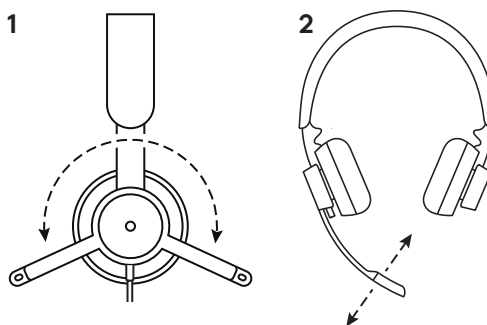

## 耳机麦克风线控和指示灯

TEAMS 版				
按钮	使用		指示灯	操作
	静音	开启静音	常亮红色	短按静音/取消静音
		取消静音	无指示灯	
	通话控制	通话呼入	闪烁白色	短按接听通话
		通话中	常亮白色	短按结束通话
	Teams 行为	正在连接 Teams	闪烁紫色	短按检查与 Teams 的连接
		连接 Teams 失败	闪烁紫色 10 秒后熄灭	
		未连接 Teams	闪烁紫色 3 次后熄灭	
		已连接 Teams	常亮紫色	短按/2 秒可进行 Teams 活动
Teams 未接通话/语音邮件/加入会议通知	闪烁紫色	短按回应 Teams 通知		
	媒体控制		无指示灯	短按播放/暂停
				按两次前进
				按三次后退
+	音量	无指示灯		短按音量上升
				-

注：仅当 Teams 运行于未锁定的 PC 或 Mac 上时，Teams 行为才有效。

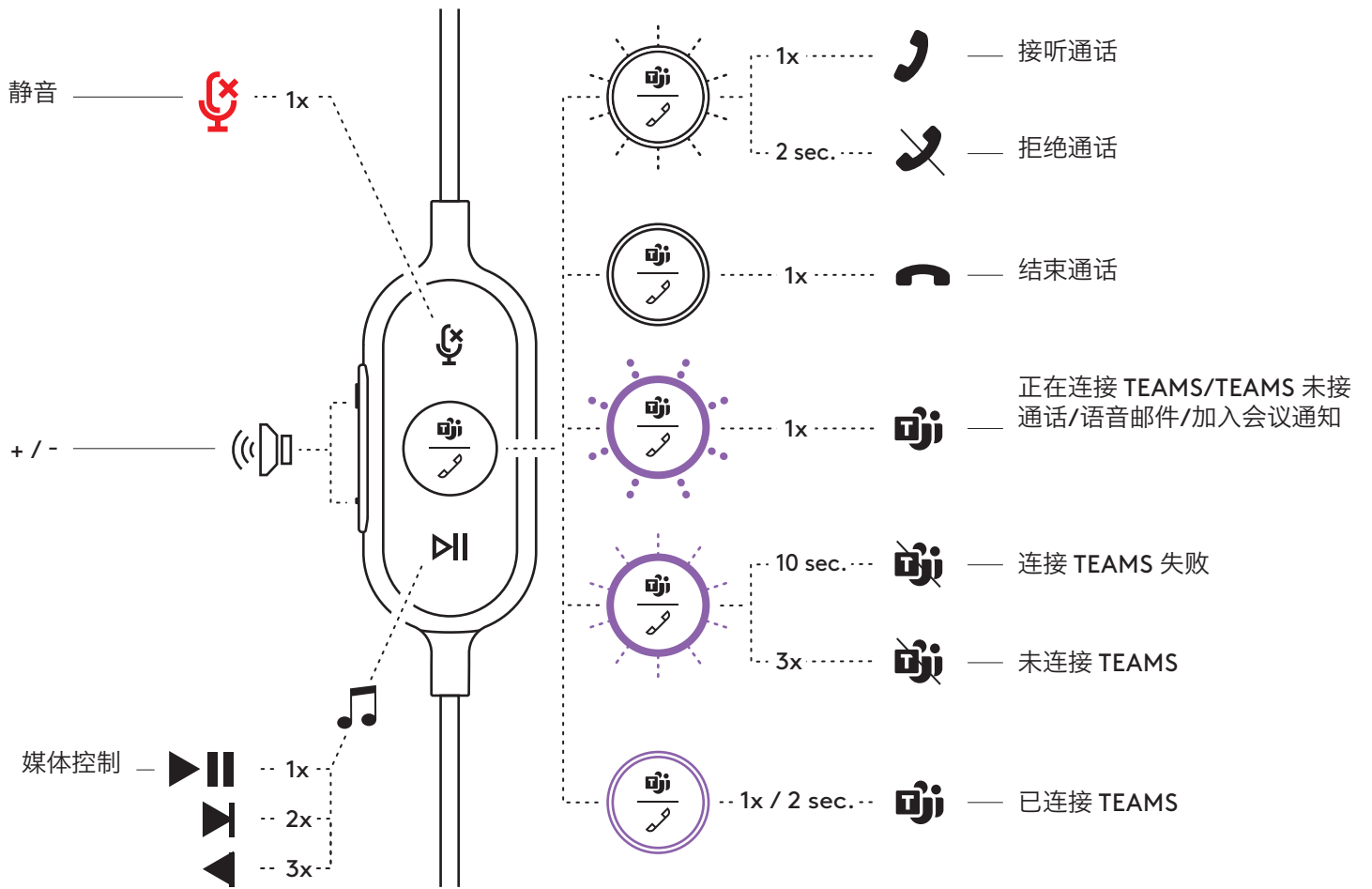

UC 版				
按钮	使用	指示灯	操作	
	静音	开启静音	常亮红色	短按静音/取消静音
		取消静音	无指示灯	
	通话控制	通话呼入	闪烁白色	短按接听通话
		通话中	常亮白色	按住 2 秒拒绝通话
	语音助手	无指示灯	短按结束通话	按住 2 秒触发语音助手*
	媒体控制	无指示灯	短按播放/暂停	
			按两次前进	
			按三次后退	
+	音量	无指示灯	短按音量上升	
-			短按音量下降	

\*语音助手功能依设备型号而异。

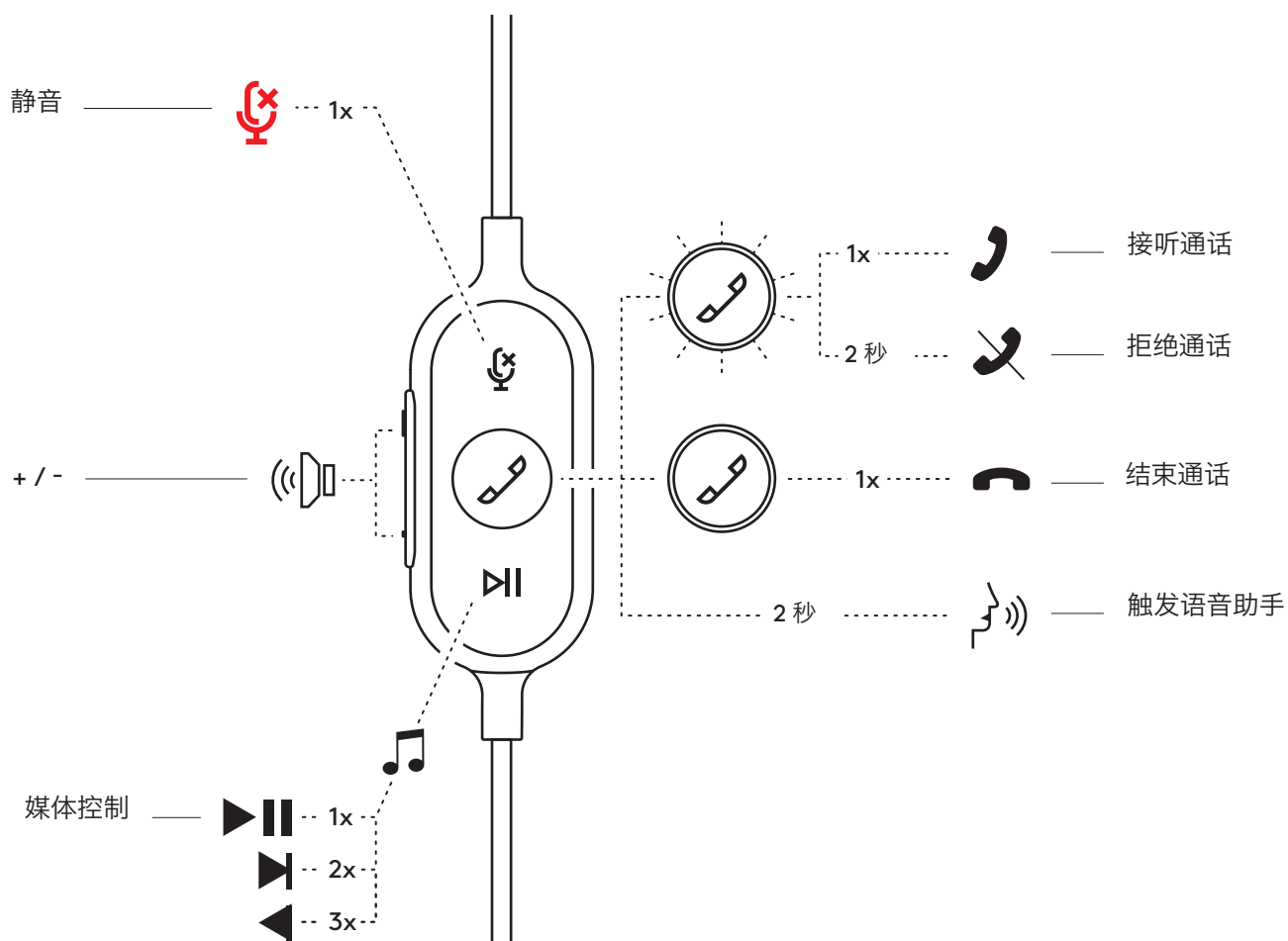

## **LOGI TUNE 桌面版 (PC 配套应用程序)**

Logi Tune 桌面版通过定期的软件和固件更新来帮助提高耳机麦克风性能，通过 5 频段均衡器自定义帮助您调节声音，并通过麦克风增益、侧音控制等功能控制声音。免干扰的迷你应用程序让您可以在进行视频通话时调整音频。

了解更多和下载 Logi Tune 桌面版：[www.logitech.com/tune](http://www.logitech.com/tune)

## **调节侧音**

侧音让您可以在对话中听到自己的声音，以了解自己的说话音量。在 Logi Tune 中选择侧音功能，并相应调节拨盘。

- 数字越大表示您听到的外部声音越多。
- 数字越小表示您听到的外部声音越少。

## **更新耳机麦克风**

建议您及时更新耳机麦克风。为此，请下载 Logi Tune：  
[www.logitech.com/tune](http://www.logitech.com/tune)

## 尺寸

耳机麦克风:

高 x 宽 x 深: 165.93 毫米 x 179.73 毫米 x 66.77 毫米

重量: 0.211 千克

耳罩尺寸:

高 x 宽 x 深: 65.84 毫米 x 65.84 毫米 x 18.75 毫米

适配器:

高 x 宽 x 深: 21.5 毫米 x 15.4 毫米 x 7.9 毫米

## 系统要求

配备可用 *USB-C* 或 *USB-A* 端口的 *Windows*、*Mac* 或 *Chrome* 电脑。*USB-C* 与移动设备的兼容性依设备型号而异。

## 技术规格

输入阻抗: 32 欧姆

灵敏度 (耳机麦克风): 99dB±3dB @ 1000Hz @30mW, 1 厘米

灵敏度 (麦克风): 主麦克风: -48 dBV/Pa, 辅助麦克风: -40 dBV/Pa

频率响应 (耳机麦克风): 20~16 kHz

频率响应 (麦克风): 100~16 kHz

线缆长度: 1.9 米



## 瞭解您的產品

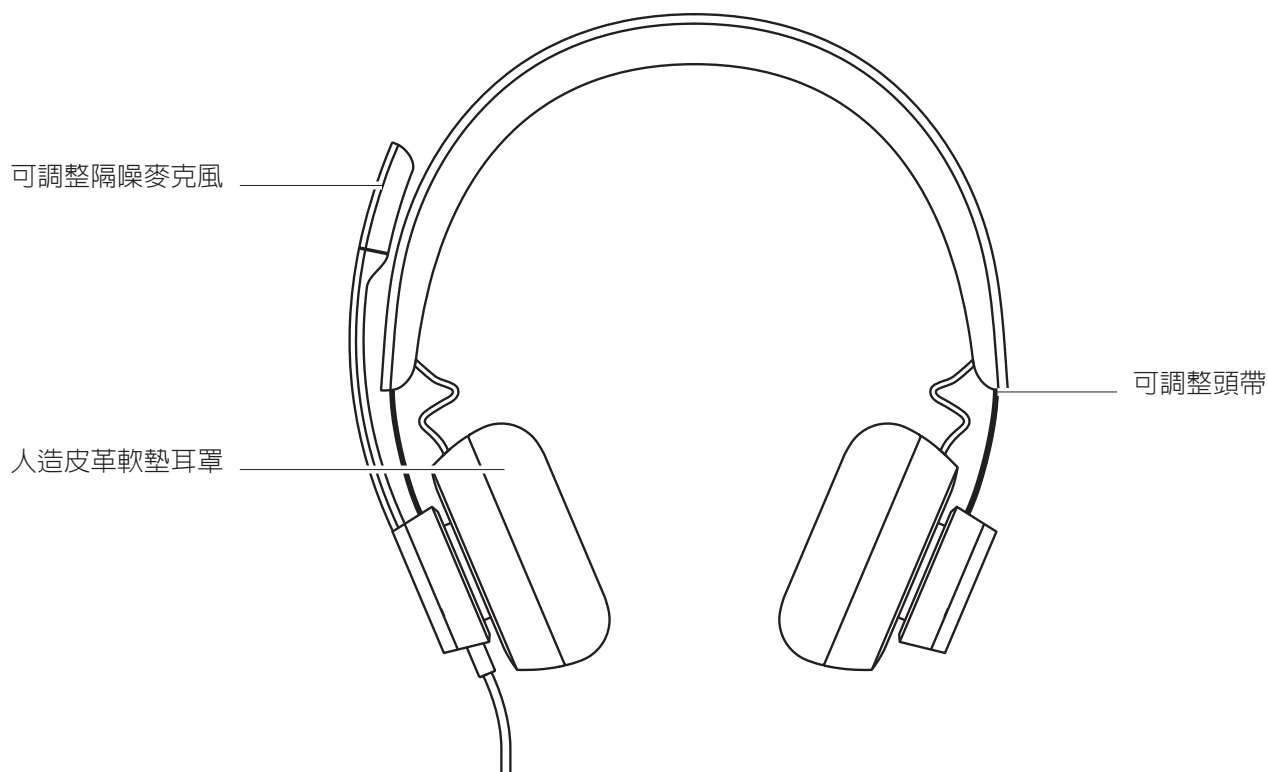

## 線控裝置

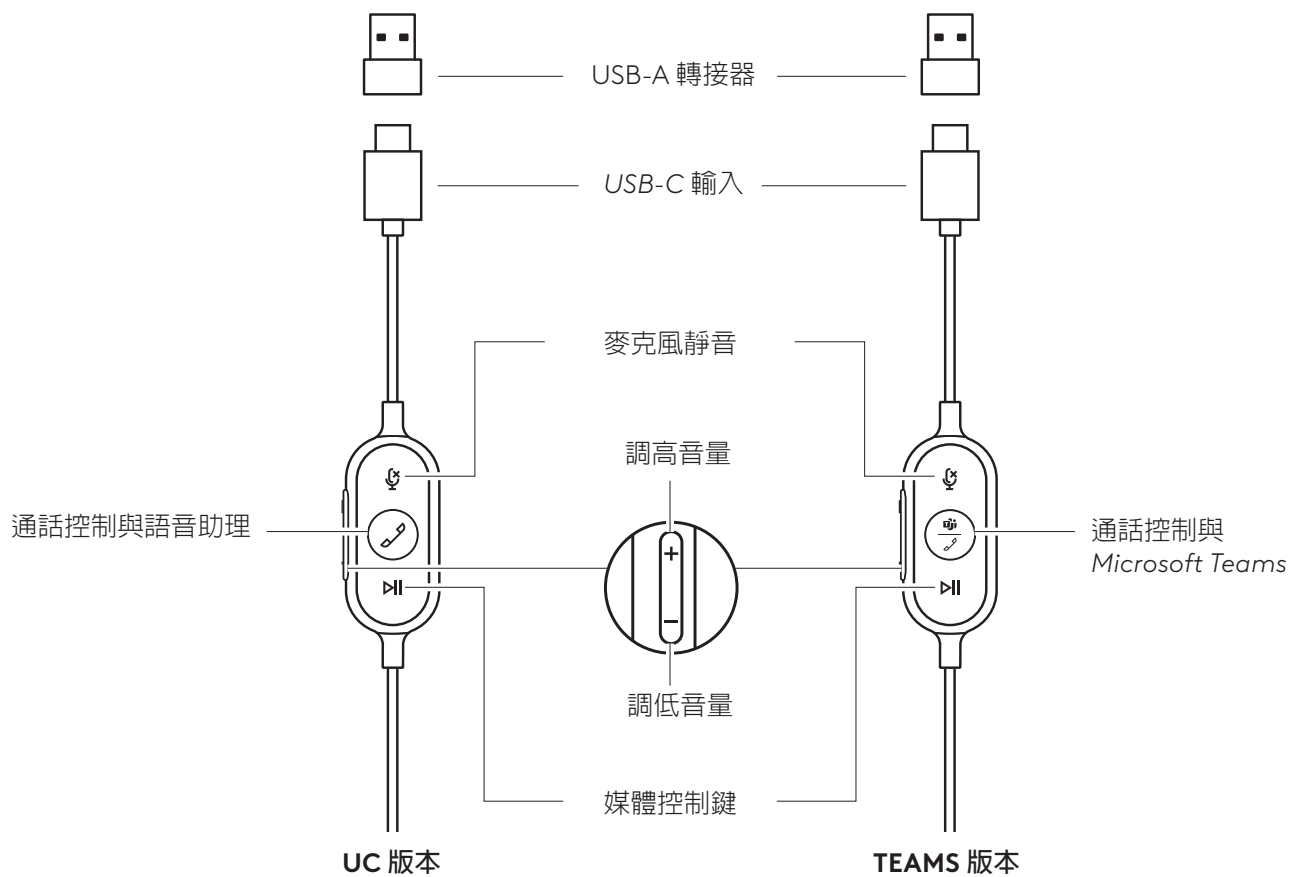

## 包裝內容

1. 具備線控裝置和 USB-C 接頭的耳機麥克風
2. USB-A 轉接器
3. 攜行袋
4. 使用者文件

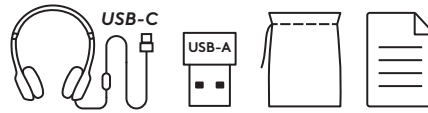

## 連接耳機麥克風

### 透過 USB-C 連接

1. 將 USB-C 接頭插入您電腦的 USB-C 連接埠。

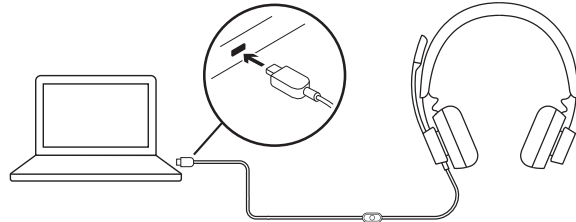

### 透過 USB-A 連接

1. 將 USB-C 接頭插入 USB-A 轉接器。
2. 將 USB-A 接頭插入您電腦的 USB-A 連接埠。

**注意：** 請僅使用 USB-A 轉接器搭配隨附的耳機麥克風。

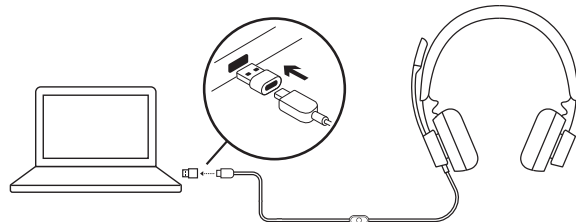

## 耳機麥克風配戴

透過滑動兩側頭帶使其開啓或關閉來調整耳機麥克風。

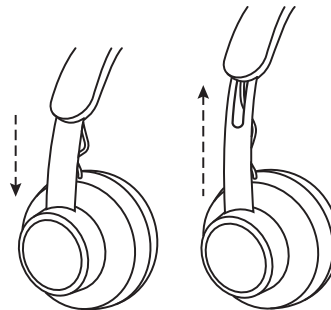

## 調整麥克風桿

1. 麥克風桿可旋轉 270 度。可將其配戴在左側或右側。為獲得最佳的音樂體驗，建議佩戴麥克風時讓麥克風位於左側。在耳機麥克風的側面可以找到左/右指示燈。
2. 彈性調整麥克風桿位置以更好地擷取聲音。

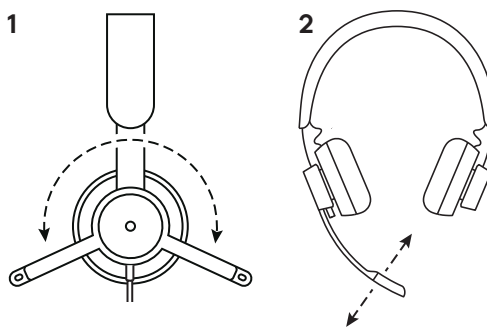



## 耳機麥克風線控裝置指示燈

TEAMS 版本				
按鈕	用途		指示燈	行動
	靜音	靜音開啓	穩定紅燈	短按靜音 / 取消靜音
		靜音關閉	無指示燈	
	通話控制	來電	閃爍白燈	短按接聽通話
		通話中	穩定白燈	按下 2 秒可掛斷來電
	Teams 活動	正在連線到 Teams	閃爍紫燈	短按檢查與 Teams 的連線
		未能連線到 Teams	閃爍紫燈 10 秒然後熄滅	
		未連線到 Teams	閃爍紫燈 3 次然後熄滅	
		已連線到 Teams	穩定紫燈	短按/Teams 活動按住 2 秒
Teams 未接的通話 / 語音郵件 / 加入會議通知	閃爍紫燈	短按可回應 Teams 通知		
	媒體控制鍵		無指示燈	短按可播放/暫停
				按兩下可播放下一曲目
				按三下可播放上一曲目
+	音量		無指示燈	短按可增加音量
				短按可減少音量

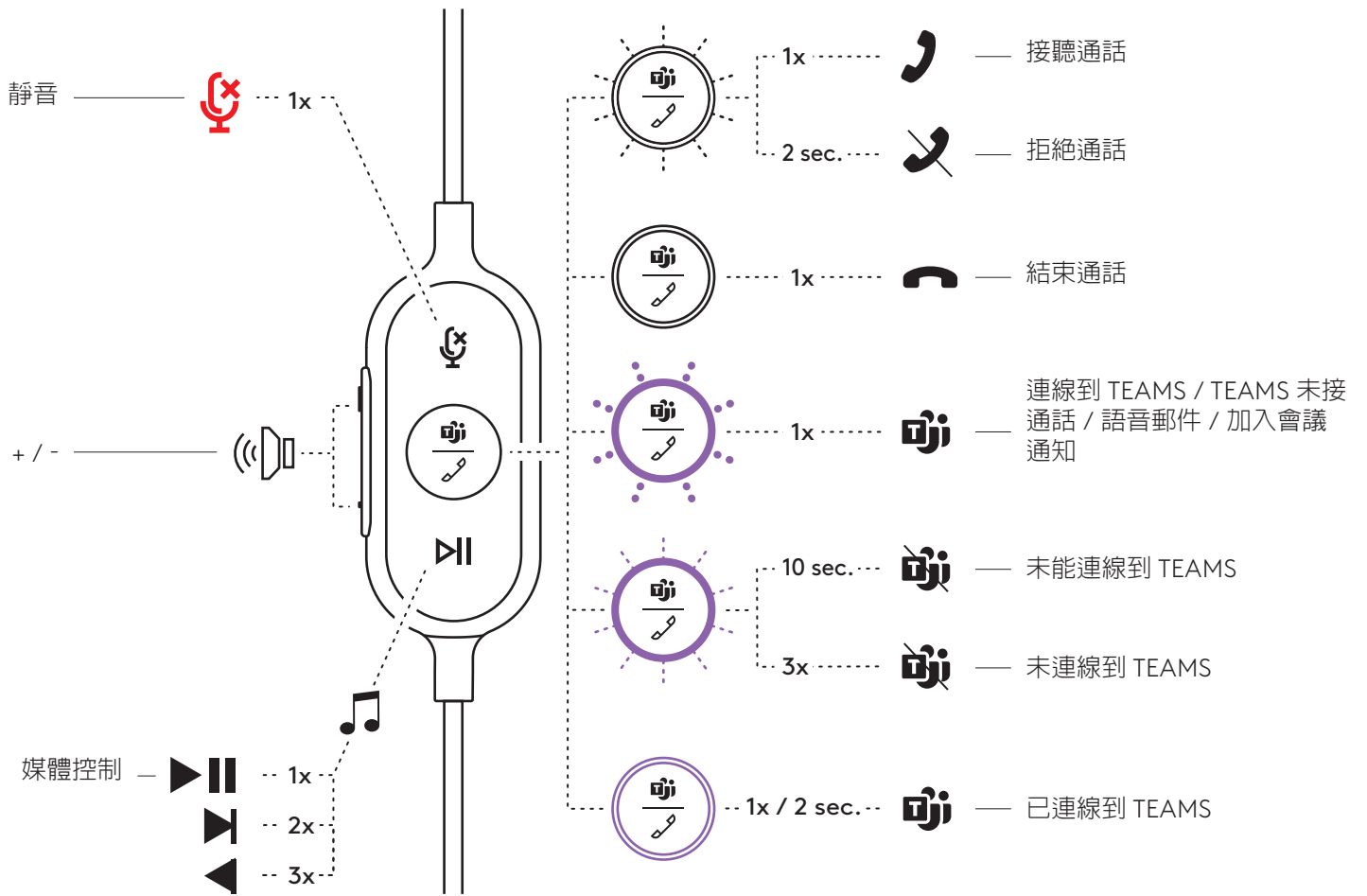
注意：Teams 活動僅在 Teams 是在未鎖定的 PC 或 Mac 上執行時才可以使用。



UC 版本				
按鈕	用途	指示燈	行動	
	靜音	靜音開啟	穩定紅燈	短按靜音 / 取消靜音
		靜音關閉	無指示燈	
	通話控制	來電	閃爍白燈	短按接聽通話
		通話中	穩定白燈	按下 2 秒可掛斷來電
	語音助理	無指示燈	短按結束通話	按下 2 秒可觸發語音助理*
	媒體控制鍵	無指示燈	短按可播放/暫停	
			按兩下可播放下一曲目	
			按三下可播放上一曲目	
+	音量	無指示燈	短按可增加音量	
-			短按可減少音量	

\* 語音助理功能視裝置型號而定。

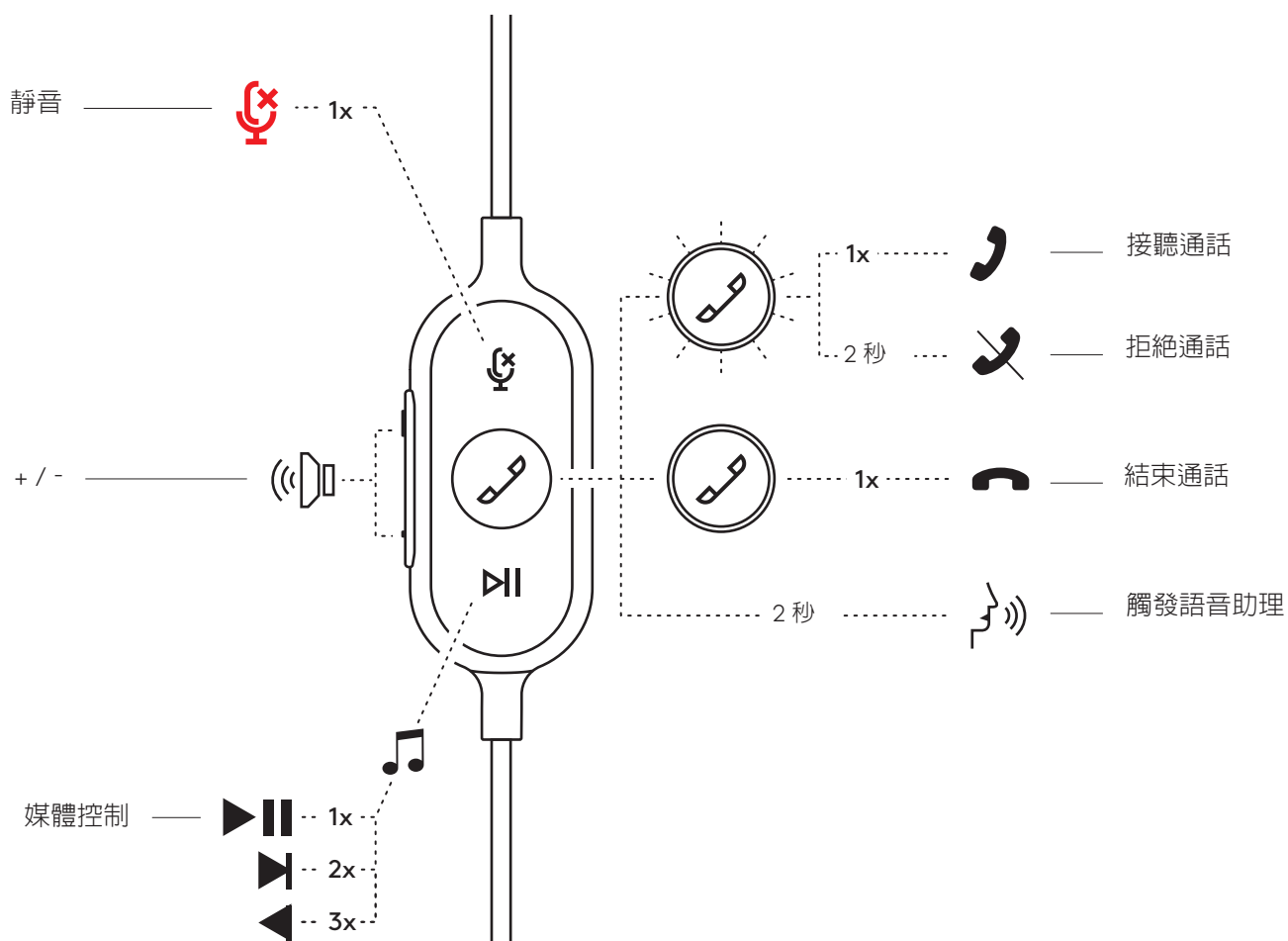

## LOGI TUNE DESKTOP (PC 伴隨應用程式)

Logi Tune Desktop 透過定期的軟體和韌體更新，協助提昇您耳機麥克風的效能，透過 5 波段等化器自訂功能協助您調整所聽到的聲音，並透過麥克風增益、側音控制等協助您控制別人聽到之您聲音的品質。這個不會使人分心的免費迷你應用程式使您可以在有視訊通話進行時，可以同時執行音訊調整。

如需 Logi Tune Desktop 的詳細資訊資訊並進行下載，請到：[www.logitech.com/tune](http://www.logitech.com/tune)

## 調整側音

側音讓您可以在通話交談期間聽到自己的聲音，讓您知道您的講話有多大聲。在 Logi Tune 中，選擇側音功能，然後對轉鈕進行相應的調整。

- 數值較高表示您會聽到較多的外部聲音。
- 數值較低表示您會聽到較少的外部聲音。

## 更新耳機麥克風

建議您更新您的耳機麥克風。若要如此做，請到下列網址下載 Logi Tune：  
[www.logitech.com/tune](http://www.logitech.com/tune)

## 尺寸

耳機麥克風：

高 x 寬 x 深：165.93 公釐 x 179.73 公釐 x 66.77 公釐

重量：0.211 公斤

耳墊尺寸：

高 x 寬 x 深：65.84 公釐 x 65.84 公釐 x 18.75 公釐

轉接器：

高 x 寬 x 深：21.5 公釐 x 15.4 公釐 x 7.9 公釐

## 系統需求

具備可用的 USB-C 或 USB-A 連接埠的 Windows、Mac 或 Chrome 電腦。行動裝置的 USB-C 相容性視裝置型號而定。

## 技術規格

輸入阻抗：32 歐姆

耳機靈敏度：99dB±3dB at 1000Hz @30mW,1cm

麥克風靈敏度：主要麥克風：-48 dBV/Pa，次要麥克風：-40 dBV/Pa

耳機麥克風頻率響應：20~16 kHz

麥克風頻率響應：100~16 kHz

連接線長度：1.9 公尺

## 제품 설명

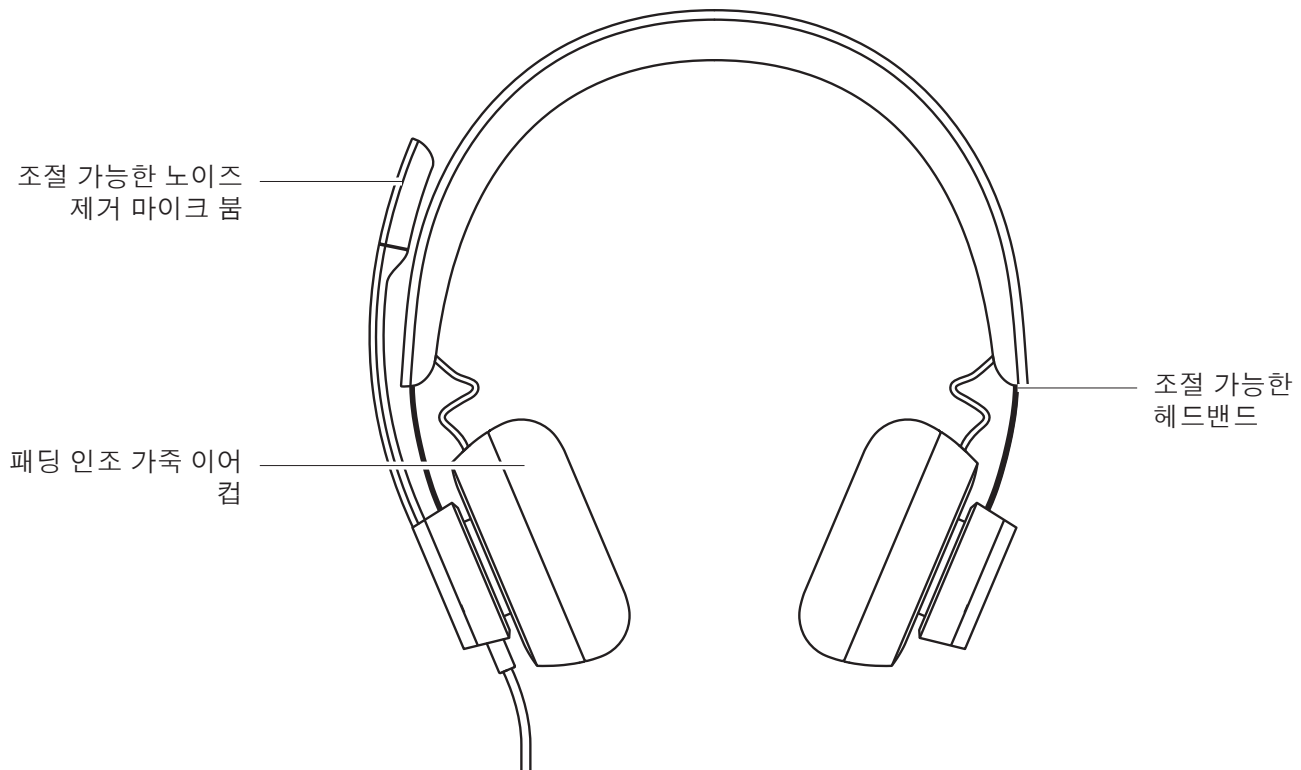

## 인라인 컨트롤러

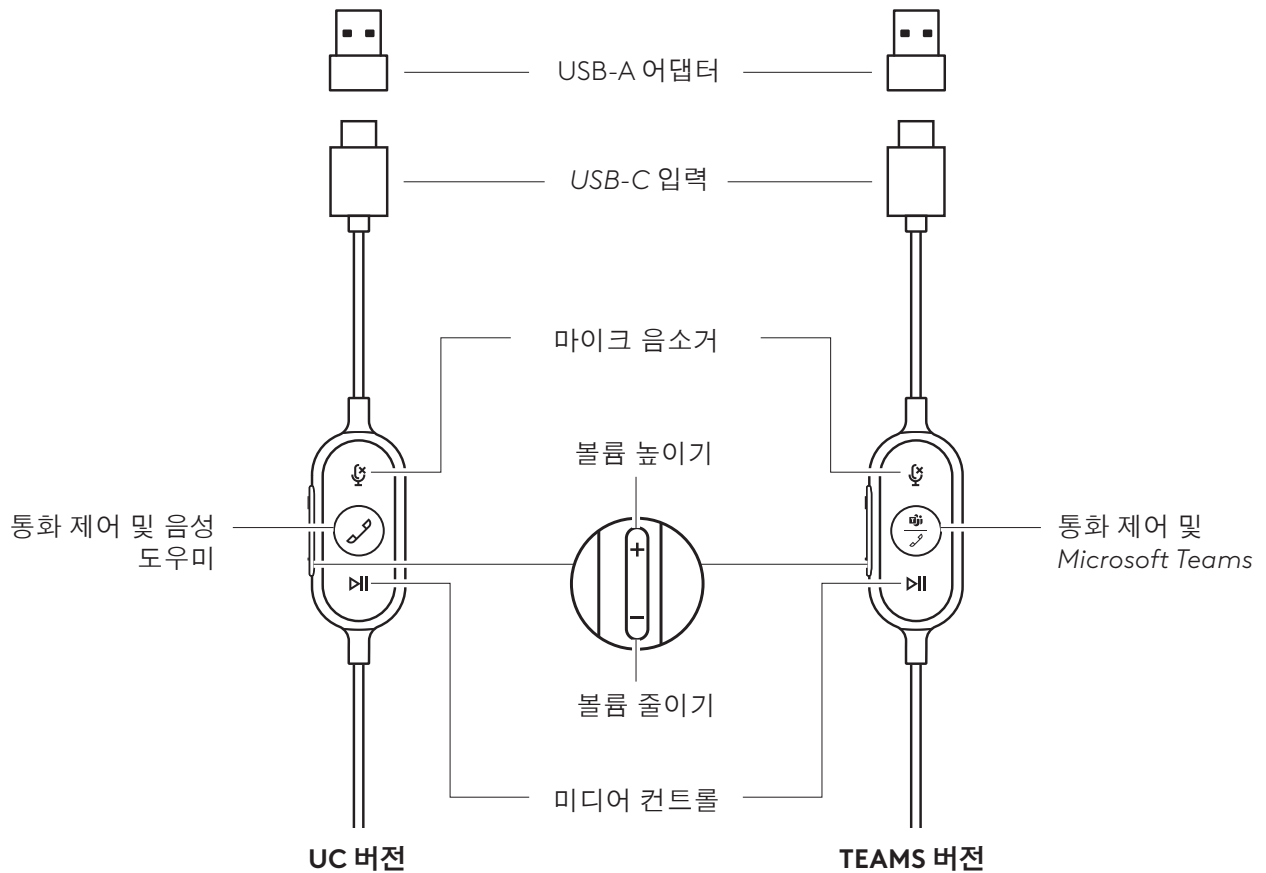



## 내용물

1. 인라인 컨트롤 및 USB-C 커넥터를 갖춘 헤드셋
2. USB-A 어댑터
3. 휴대용 가방
4. 사용 설명서

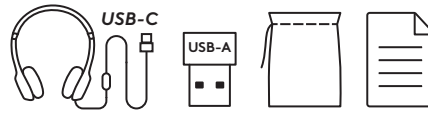

## 헤드셋 연결

### USB-C 연결

1. USB-C 커넥터를 USB-C 포트에 연결합니다.

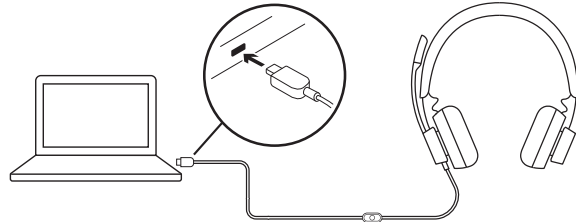

### USB-A 연결

1. USB-C 커넥터를 USB-A 어댑터에 연결합니다.
2. USB-A 커넥터를 컴퓨터 USB-A 포트에 연결합니다.

**참고:** 제공된 USB-A 어댑터는 헤드셋 연결용으로만 사용하십시오.

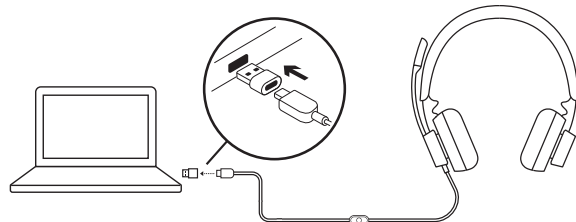

## 헤드셋 핏

헤드셋을 조정하려면 양쪽 헤드밴드를 밀거나 당기십시오.

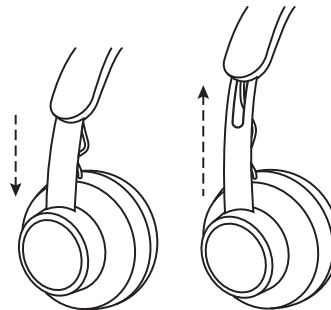

## 마이크 붐 조절

1. 마이크 붐은 270도 회전 가능합니다. 왼쪽 또는 오른쪽으로 착용할 수 있습니다. 최상의 음악 경험을 위해 마이크가 왼쪽에 오게 헤드셋을 착용하는 것이 좋습니다. 헤드셋 측면에 왼쪽/오른쪽 표시등이 있습니다.
2. 유연한 마이크 붐의 위치를 조절하면 목소리를 더 잘 들을 수 있습니다.

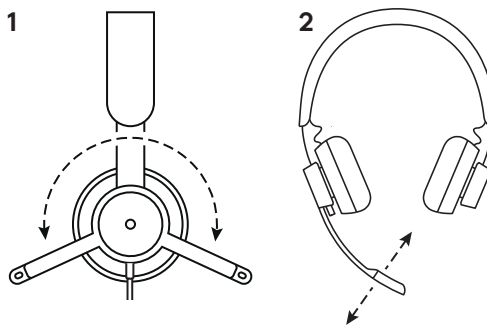

헤드셋 인라인 컨트롤 및 표시등

TEAMS 버전				
버튼	용도		표시등	동작
	음소거	음소거 켜짐	빨간색으로 유지	짧게 눌러 음소거/음소거 해제
		음소거 꺼짐	불빛 없음	
	통화 제어	걸려온 통화	하얀색으로 깜박임	짧게 눌러 통화 응답
		진행 중인 통화	흰색으로 유지	2초간 눌러 통화 거부
		Teams 연결	보라색으로 깜박임	짧게 눌러 Teams 연결 확인
	Teams 연결 실패	10초 동안 보라색으로 깜박인 뒤 꺼짐		
	Teams 연결되지 않음	보라색으로 3번 깜박인 뒤 꺼짐		
	Teams 버튼	Teams 연결됨	보라색으로 유지	Teams 버튼 짧게/2초 누르기
Teams 부재중 전화/음성 메일/미팅 참가 알림		보라색으로 깜박임	짧게 눌러 Teams 알림 응답	
	미디어 컨트롤		불빛 없음	짧게 눌러 재생/일시 정지
				두 번 눌러 트랙 앞으로
				세 번 눌러 트랙 뒤로
+	볼륨	불빛 없음		짧게 눌러 볼륨 높이기
				짧게 눌러 볼륨 줄이기
-				

참고: Teams 버튼은 잠겨 있지 않은 PC 또는 Mac에서 Teams를 사용 중일 때만 작동됩니다.

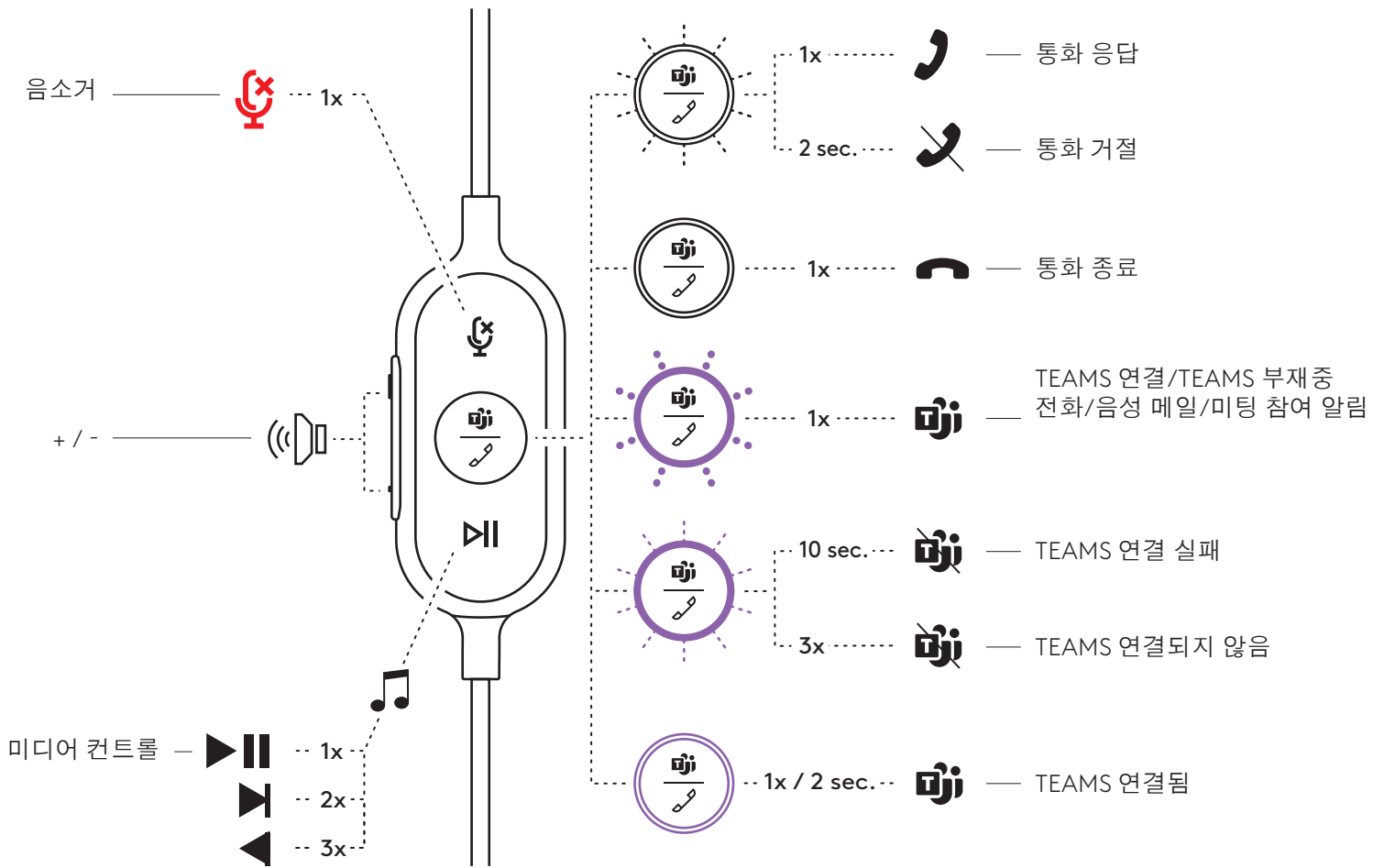

UC 버전				
버튼	용도		표시등	동작
	음소거	음소거 켜짐	빨간색으로 유지	짧게 눌러 음소거/음소거 해제
		음소거 꺼짐	불빛 없음	
	통화 제어	걸려온 통화	하얀색으로 깜박임	짧게 눌러 통화 응답
		진행 중인 통화	흰색으로 유지	2초간 눌러 통화 거부
	음성 지원		불빛 없음	짧게 눌러 통화 종료
	미디어 컨트롤		불빛 없음	2초 동안 눌러 음성 도우미 불러오기*
				짧게 눌러 재생/일시 정지
				두 번 눌러 트랙 앞으로
				세 번 눌러 트랙 뒤로
+ -	볼륨		불빛 없음	짧게 눌러 볼륨 높이기
				짧게 눌러 볼륨 줄이기

\*음성 도우미 기능은 장치 모델에 따라 달라집니다.

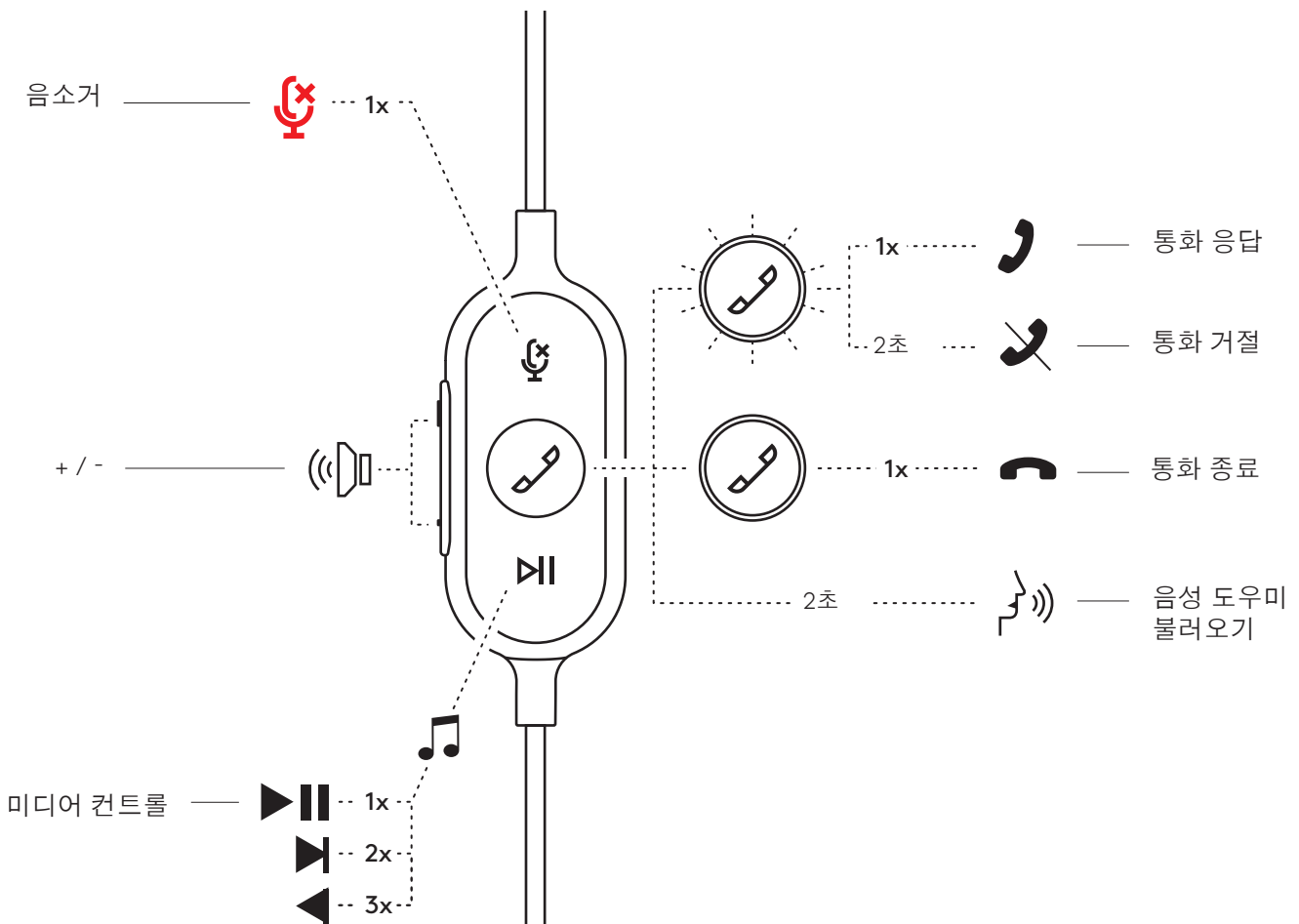

## LOGI TUNE 데스크탑(PC 앱)

Logi Tune 데스크탑은 주기적인 소프트웨어 및 펌웨어 업데이트로 헤드셋 성능 향상에 도움이 되며 5밴드 EQ 커스텀으로 들리는 소리를 조절할 수 있습니다. 마이크 게인, 측음 컨트롤 등으로 본인의 음성을 제어하는 것을 도와줍니다. 편리한 미니맵으로 화상 회의 중에도 오디오를 조절할 수 있습니다.

[www.logitech.com/tune](http://www.logitech.com/tune)에서 Logi Tune 데스크탑에 대해 더 알아보고 다운로드하세요.

## 사이드톤 조절

대화하는 동안 자신의 목소리를 들을 수 있게 해줌으로써 자신이 얼마나 큰 소리로 말하고 있는지를 인식하게 해줍니다. Logi Tune에서 측음 기능을 선택하고 알맞게 다이얼을 조정합니다.

- 숫자가 높을수록 외부 소리가 더 많이 들린다는 뜻입니다.
- 숫자가 낮을수록 외부 소리가 덜 들린다는 뜻입니다.

## 헤드셋 업데이트

헤드셋을 업데이트하는 것이 좋습니다. 업데이트하려면 [www.logitech.com/tune](http://www.logitech.com/tune)에서 Logi Tune을 다운로드합니다.

## 사이즈

헤드셋:

높이 x 너비 x 깊이: 165.93mm x 179.73mm x 66.77mm

무게: 0.211 Kg

이어 패드 치수:

높이 x 너비 x 깊이: 65.84mm x 65.84mm x 18.75mm

어댑터:

높이 x 너비 x 깊이: 21.5mm x 15.4mm x 7.9mm

## 시스템 요구 사항

USB-C 또는 USB-A 포트가 달린 Windows, Mac, Chrome 기반 컴퓨터. 모바일 장치 USB-C 호환성은 장치 모델에 따라 다를 수 있습니다.

## 기술 사양

입력 임피던스: 32 Ohms

감도(헤드폰): 1000Hz @30mW에서 99dB±3dB,1cm

감도(마이크): 메인 마이크: -48dBV/Pa, 보조 마이크: -40dBV/Pa

주파수 응답(헤드셋): 20~16 kHz

주파수 응답(마이크): 100~16 kHz

케이블 길이: 1.9 m