

LOGITECH ZONE 900 REPLACEABLE EARPAD COVERS

LOGITECH ZONE 900 HOUSSES DE COUSSINETS REMPLAÇABLES

Complete Setup Guide
Guide d'installation complet

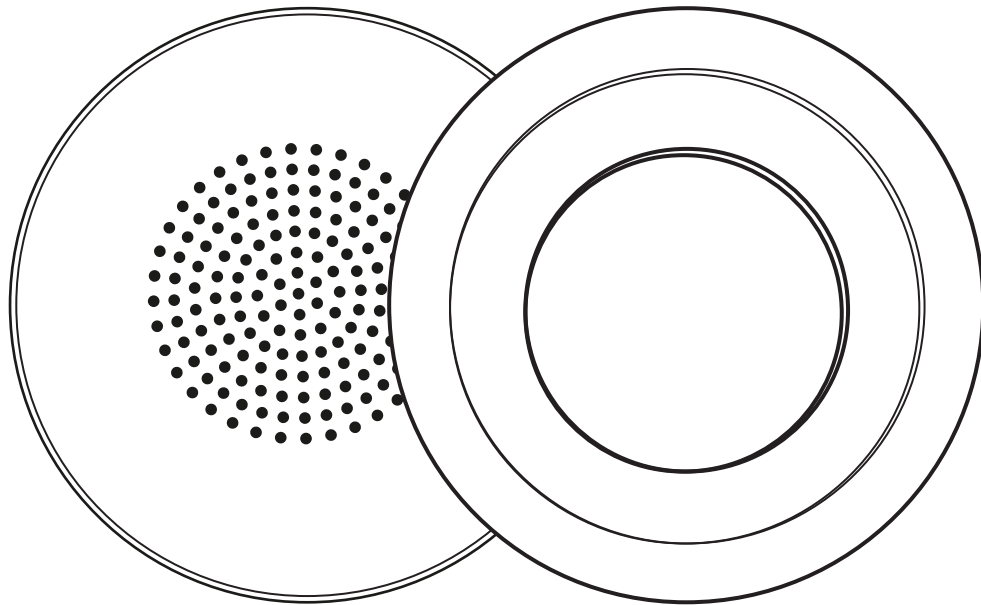

CONTENTS

English3

Français7

Español 11

Português 15

KNOW YOUR PRODUCT

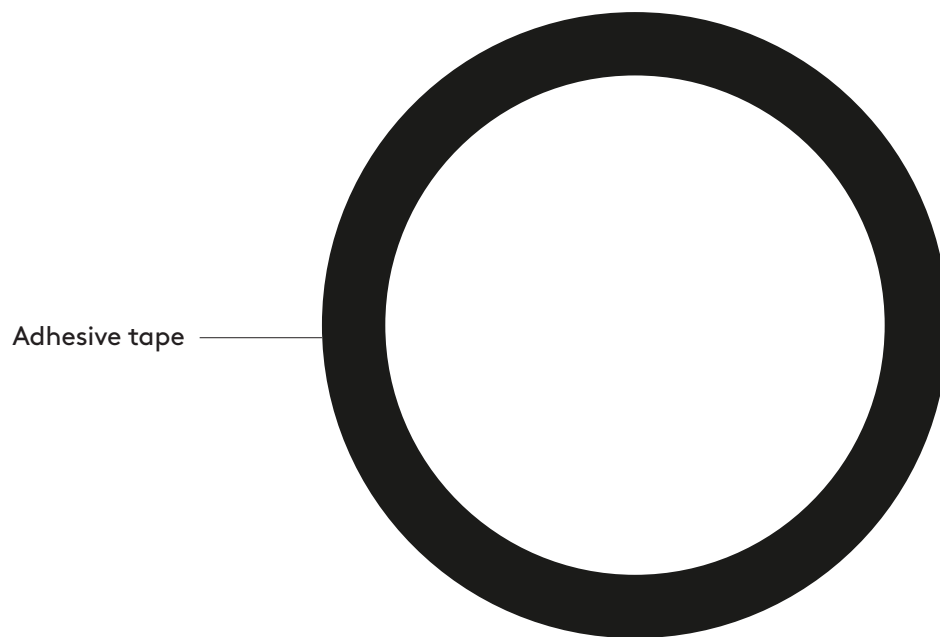
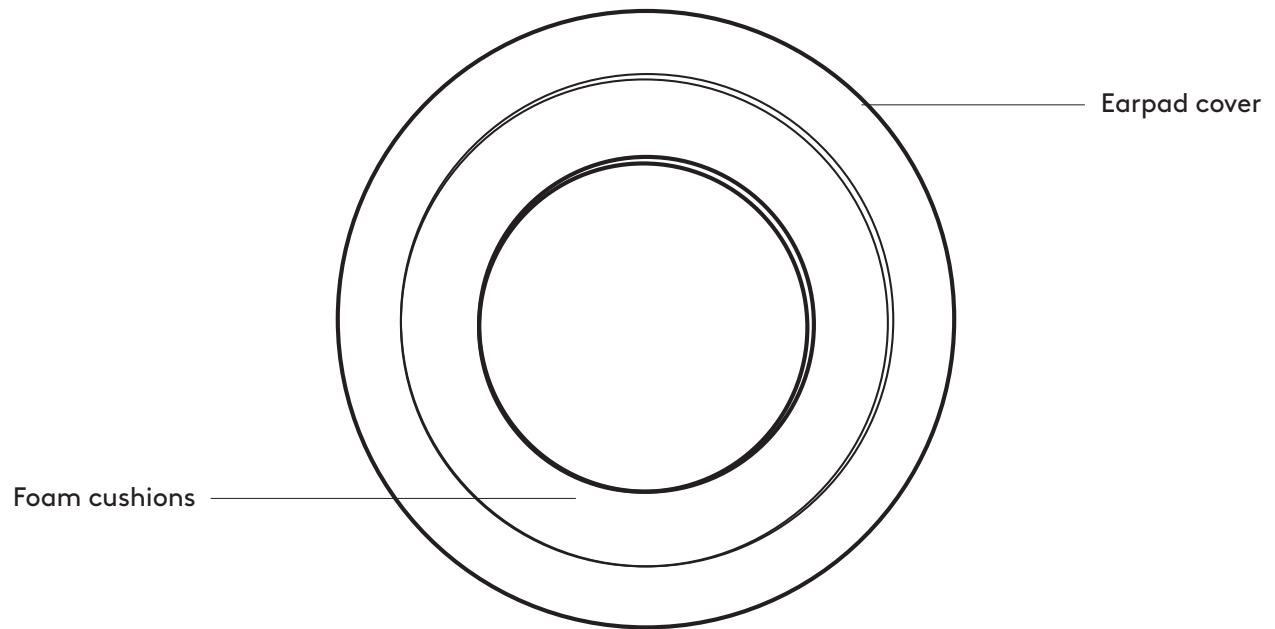

WHAT'S IN THE BOX

1. 1 pair (2 pcs) of replaceable earpad covers
2. 1 pair (2 pcs) of foam cushions
3. 1 pair (2 pcs) of adhesive tapes

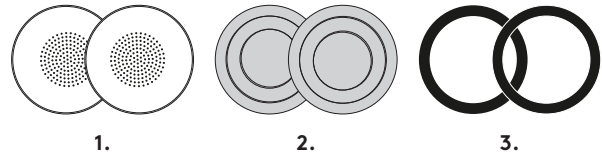

REPLACING EARPAD COVERS

1. Take the existing earpad cover off by carefully pinching the cover.

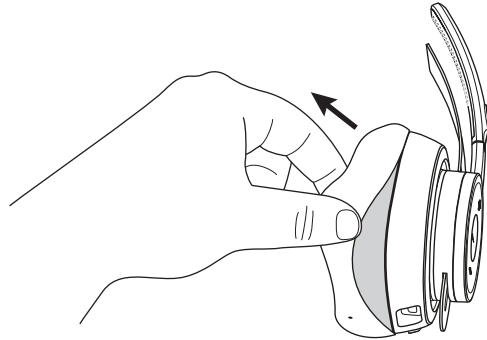

2. Remove the earpad cover slowly until it is completely off.

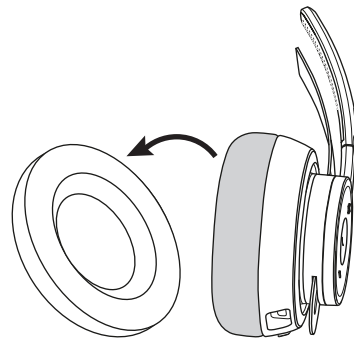

Make sure not to pinch the foam cushion which can be damaged easily.

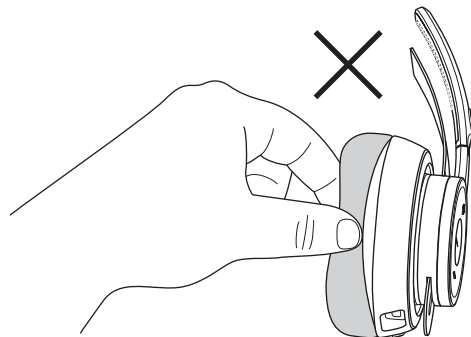

3. If foam cushion is damaged, please follow the steps below.
- a. Peel the foam cushion off and replace with a new one.

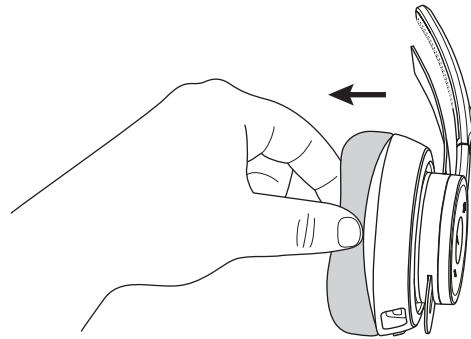

- b. Place the tape on the top of the ear cup first.

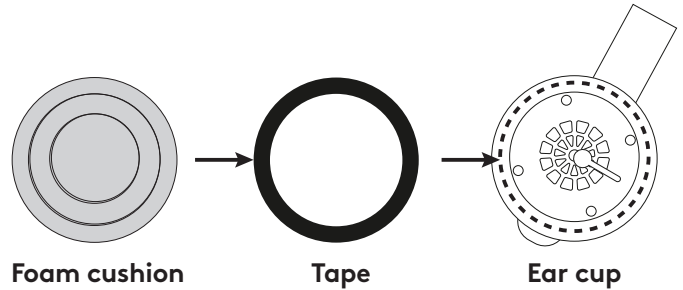

- c. Then attach the foam cushion to the tape.

4. Grasp the new earpad cover, making sure that the small holes on the side align with the top and bottom of the ear cup. It should align with the USB C port at the bottom.

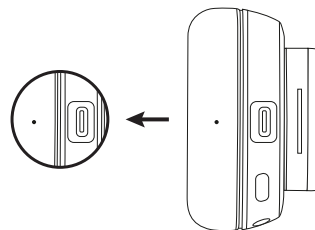

5. Starting from the top, slot the edge of the earpad cover inside the gap. Put the edge of the cover into the gap around the earcan.

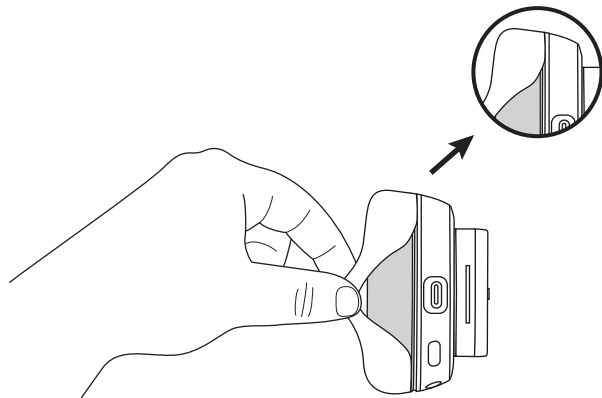

6. After completing, gently pat the earcup several times to push the air out.

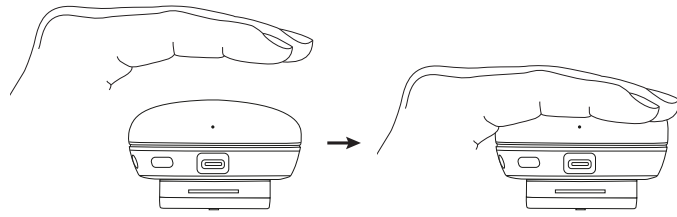

DIMENSIONS

EARPAD COVERS:

Height x Width x Depth: 70.7 mm x 70.7 mm x 16.4 mm

www.logitech.com/support/zone900

PRÉSENTATION DU PRODUIT

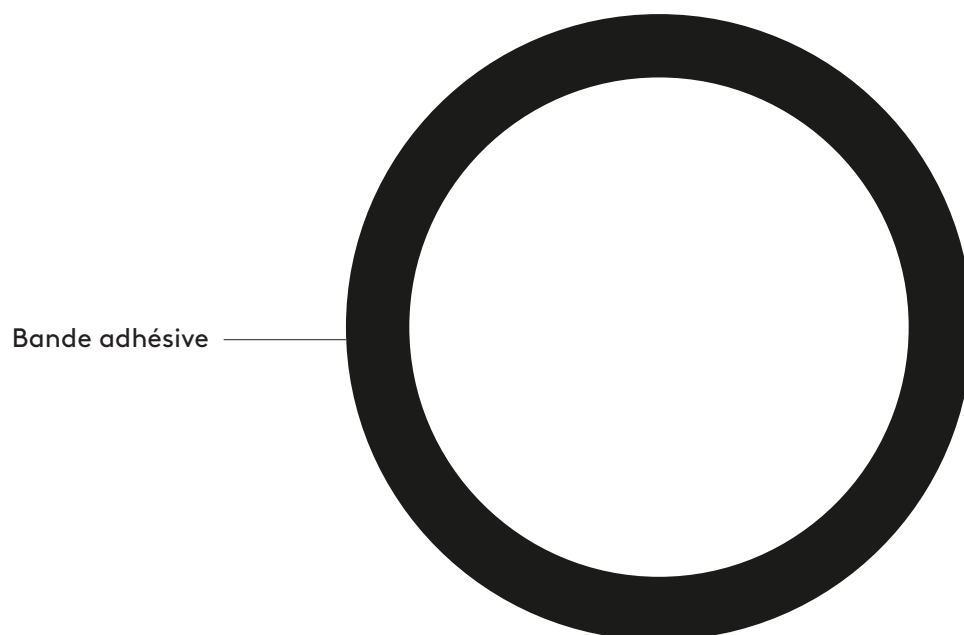
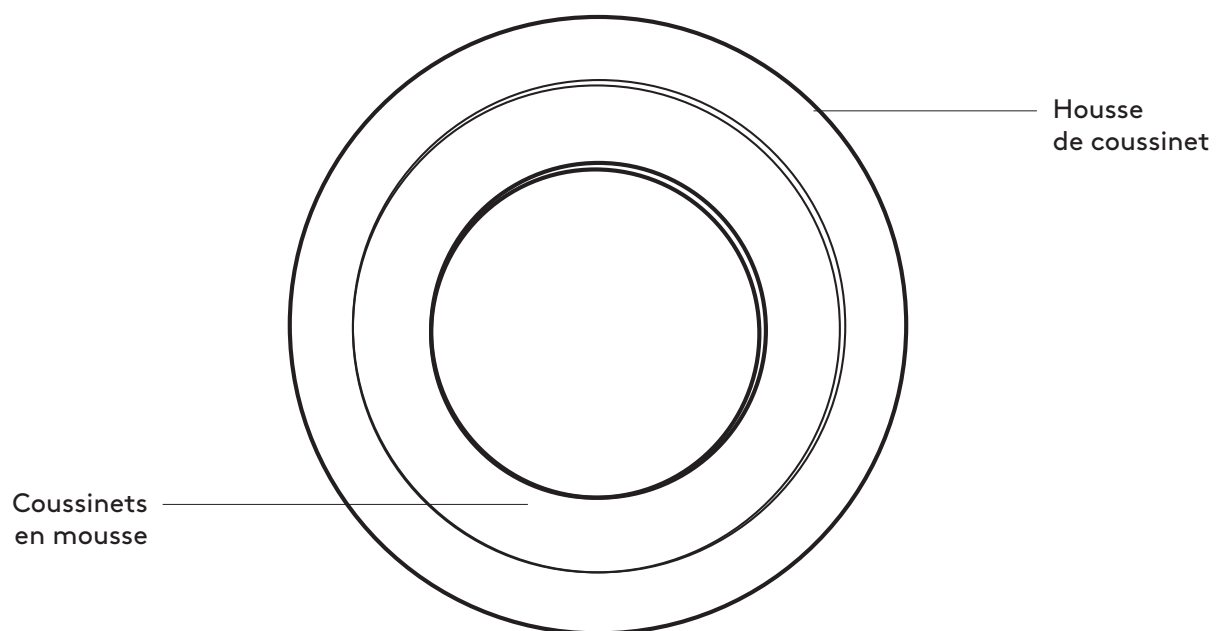

CONTENU DU COFFRET

1. 1 paire (2 pièces) de housses de coussinets remplaçables
2. 1 paire (2 pièces) de coussinets en mousse
3. 1 paire (2 pièces) de bandes adhésives

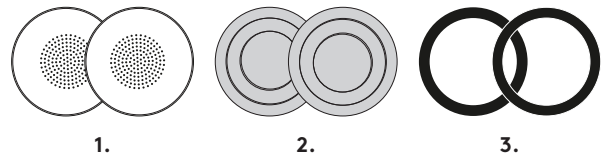

REPLACER LES HOUSSES DE COUSSINETS

1. Retirez la housse du coussinet existant en la pinçant délicatement.

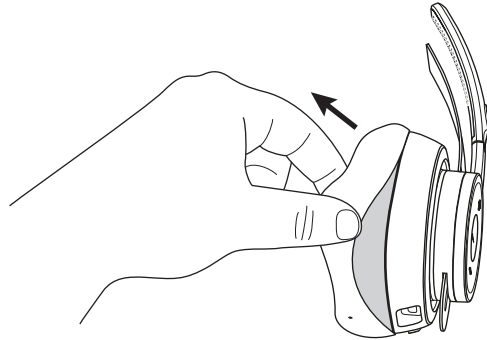

2. Enlevez lentement la housse du coussinet jusqu'à ce qu'elle soit entièrement retirée.

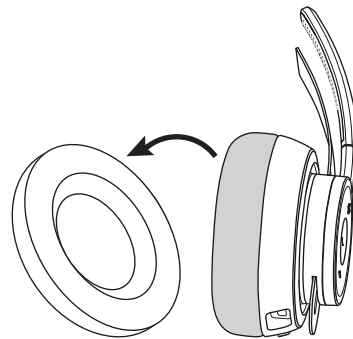

Veillez à ne pas pincer le coussinet en mousse qui peut être facilement endommagé.

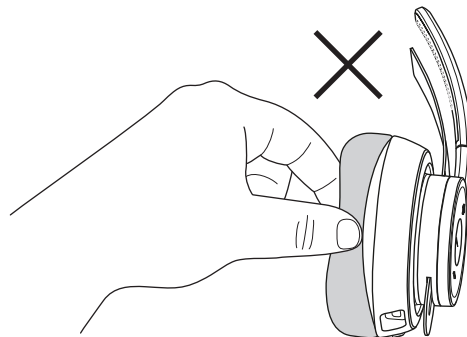

3. Si le coussinet en mousse est endommagé, veuillez suivre les étapes ci-dessous.

a. Retirez le coussinet en mousse et remplacez-le par un nouveau.

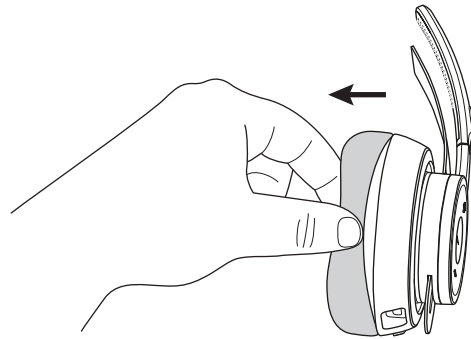

b. Placez d'abord la bande adhésive sur le dessus de l'oreillette.

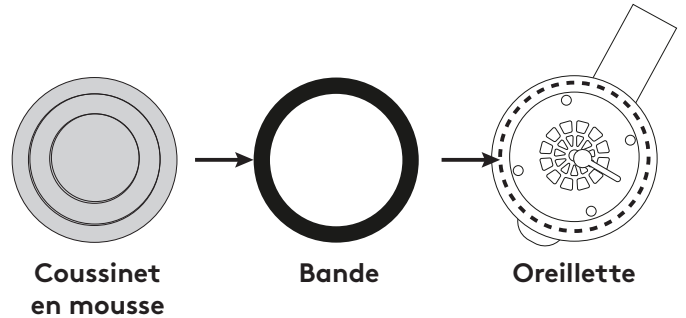

c. Ensuite, fixez le coussinet en mousse à la bande.

4. Saisissez la nouvelle housse de coussinet en vous assurant que les petits trous sur le côté soient alignés avec le haut et le bas de l'oreillette. Elle doit être alignée avec le port USB C en bas.

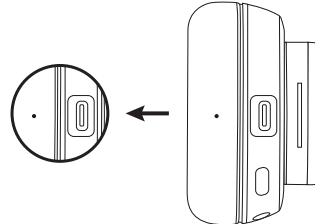

5. En commençant par le haut, insérez le bord de la housse du coussinet dans l'espace prévu à cet effet. Placez le bord de la housse dans l'espace autour de l'oreillette.

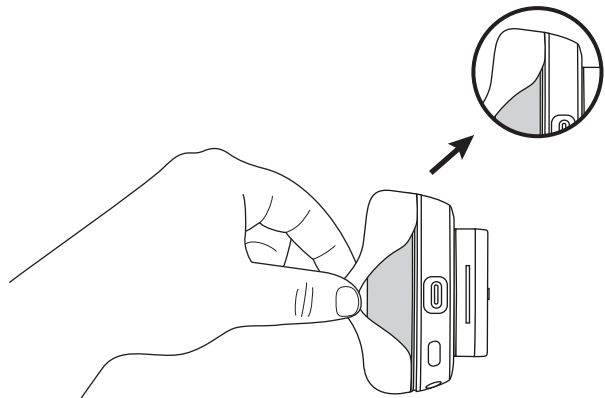

6. Après avoir terminé, tapotez délicatement l'oreillette plusieurs fois pour faire sortir l'air.

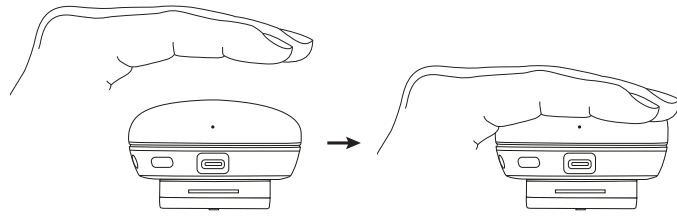

DIMENSIONS

HOUSES DE COUSSINETS:

Hauteur x largeur x profondeur:
70,7 mm x 70,7 mm x 16,4 mm

www.logitech.com/support/zone900

COMPONENTES DEL PRODUCTO

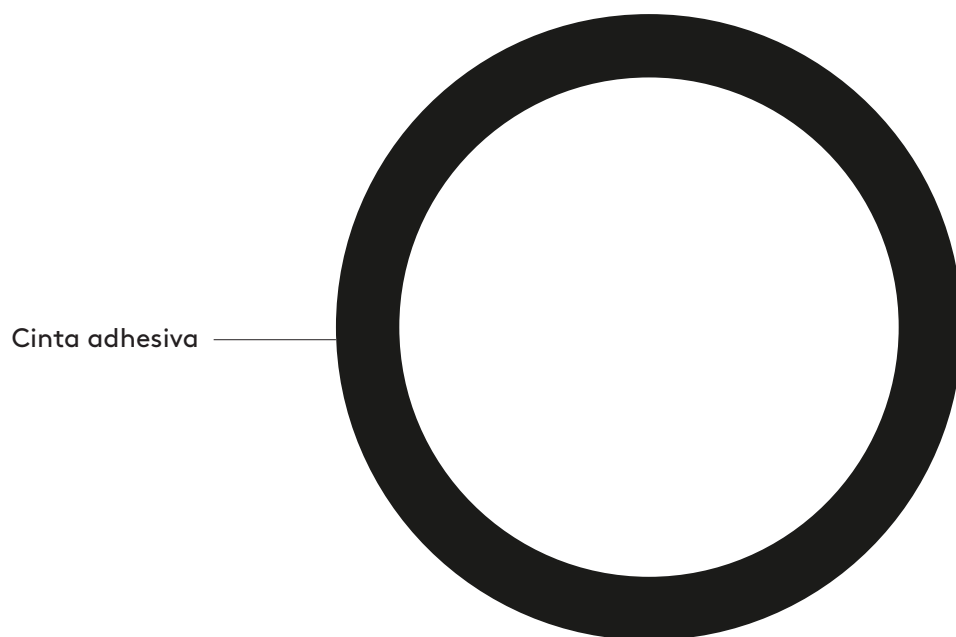
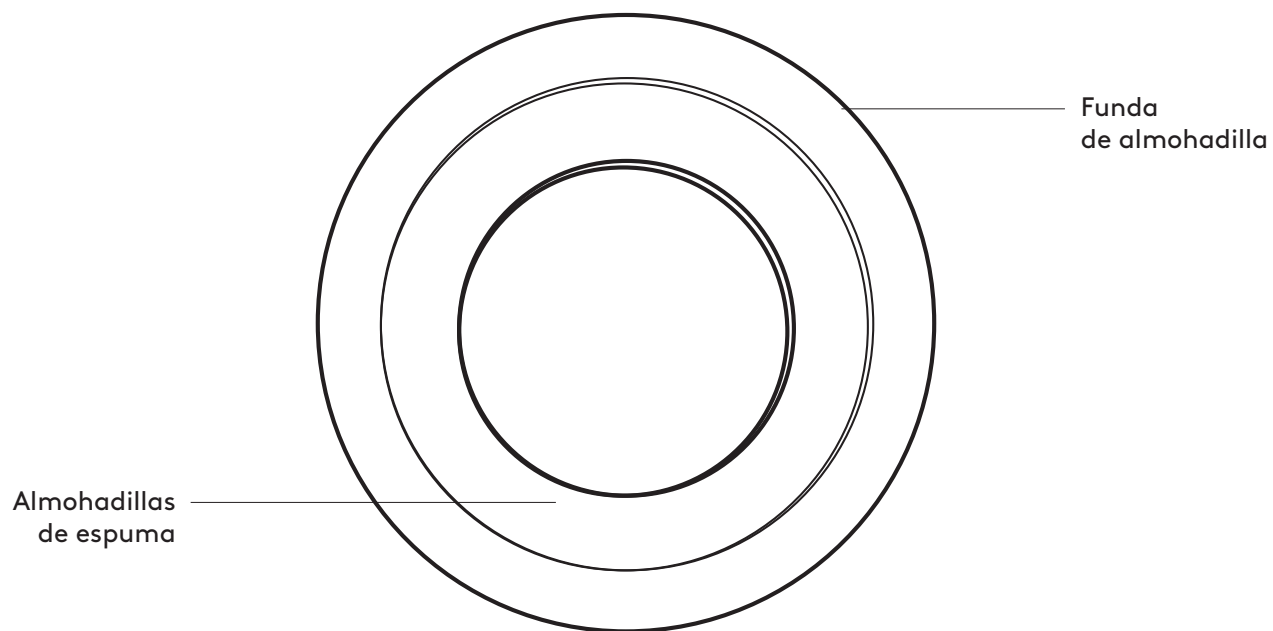

CONTENIDO DE LA CAJA

1. 1 par (2 unidades) de fundas de almohadillas reemplazables
2. 1 par (2 unidades) de almohadillas de espuma
3. 1 par (2 unidades) de cintas adhesivas

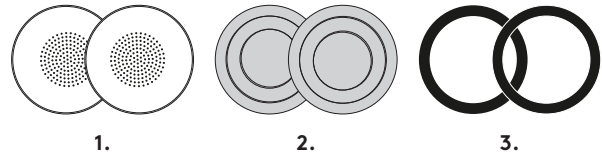

REEMPLAZAR LAS FUNDAS DE ALMOHADILLA

1. Quita la funda de almohadilla existente. Para ello, pellízcala con cuidado.

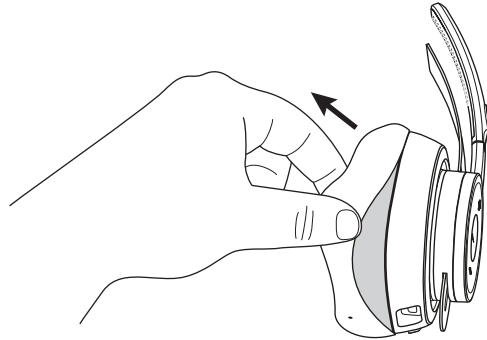

2. Retira lentamente la funda de almohadilla hasta que salga por completo.

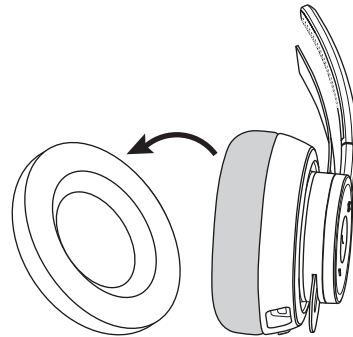

Asegúrate de no pellizcar la almohadilla de espuma ya que puede dañarse fácilmente.

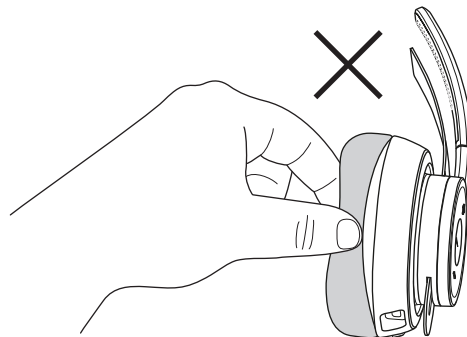

3. Si se daña la almohadilla de espuma, sigue los pasos a continuación.
a. Retira la almohadilla de espuma y reemplázala con una nueva.

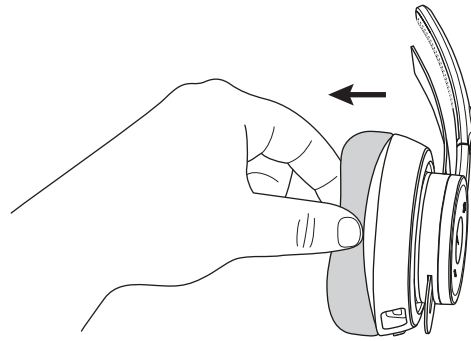

- b. Coloca la cinta primero en la parte superior de la copa.

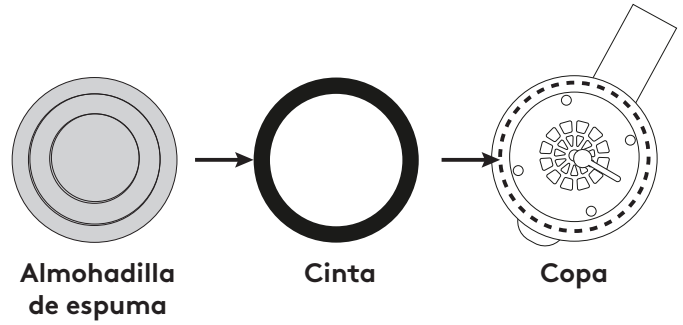

- c. Luego adhiere la almohadilla de espuma a la cinta.

4. Agarra la nueva funda de almohadilla, asegurándote de que los pequeños agujeros en el lateral se alineen con la parte superior e inferior de la copa. Debería alinearse con el puerto USB C en la parte inferior.

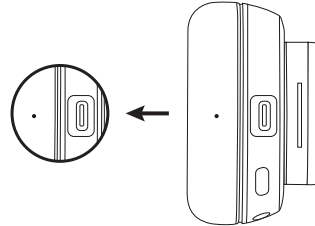

5. Comenzando desde arriba, encaja el borde de la funda de almohadilla dentro del hueco. Pon el borde de la funda en el hueco alrededor del auricular.

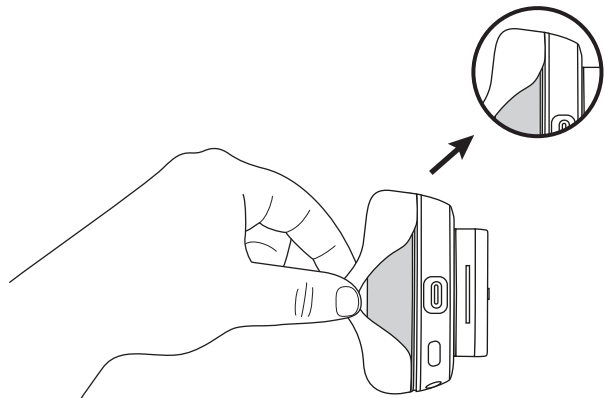

6. Después de terminar, palmea suavemente la copa varias veces para expulsar el aire.

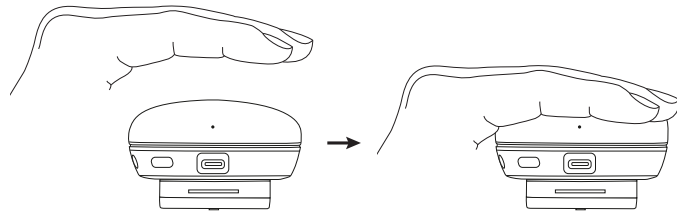

DIMENSIONES

FUNDAS DE ALMOHADILLAS:

Altura x Anchura x Profundidad:
70,7 mm x 70,7 mm x 16,4 mm

www.logitech.com/support/zone900

CONHECER O PRODUTO

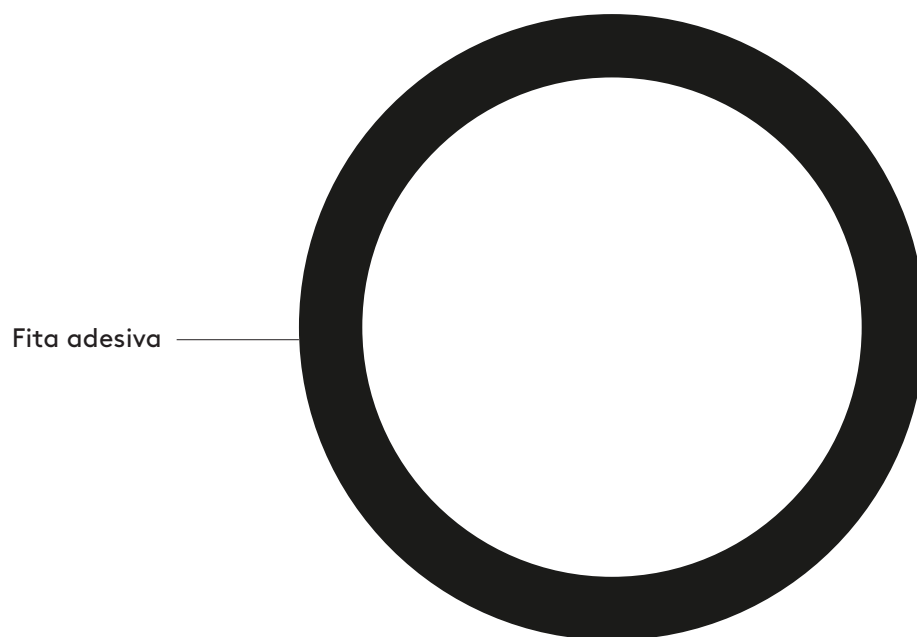
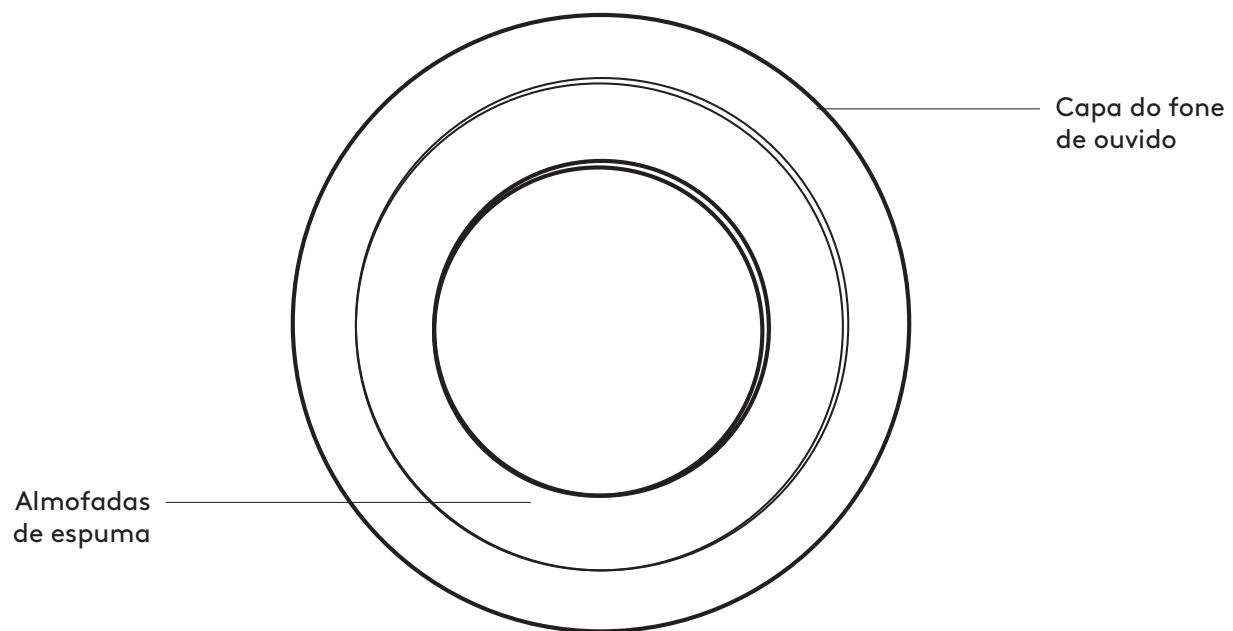

ITENS INCLUÍDOS NA EMBALAGEM

1. 1 par (2 peças) de capas substituíveis para o fone de ouvido
2. 1 par (2 peças) de almofadas de espuma
3. 1 par (2 peças) de fitas adesivas

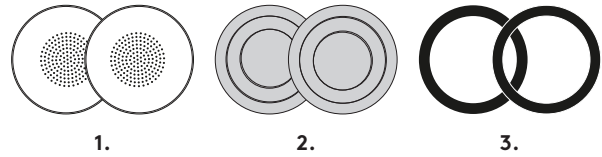

SUBSTITUIR CAPAS DE FONE DE OUVIDO

1. Retire a capa do fone de ouvido existente, apertando-a cuidadosamente.

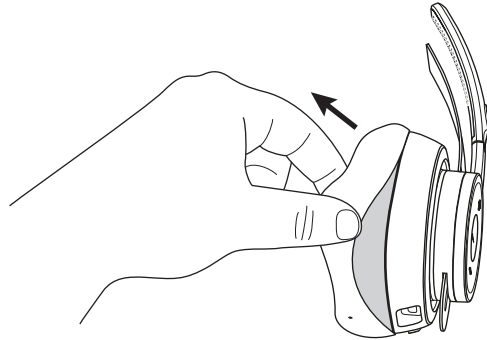

2. Remova a capa do fone de ouvido lentamente até que saia completamente.

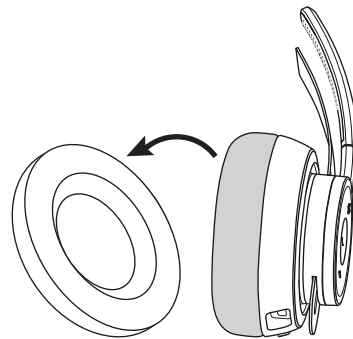

Cuidado para não apertar a almofada de espuma com muita força, pois pode ser danificada facilmente.

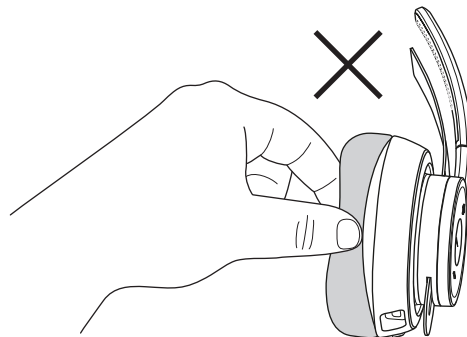

3. Se a almofada de espuma estiver danificada, siga as etapas abaixo.

a. Retire a almofada de espuma e substitua-a por uma nova.

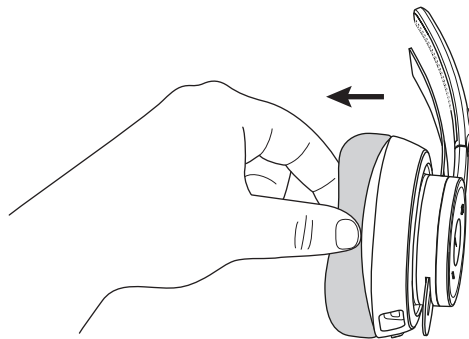

b. Coloque a fita na parte superior da almofada de ouvido primeiro.

c. Em seguida, prenda a almofada de espuma com a fita.

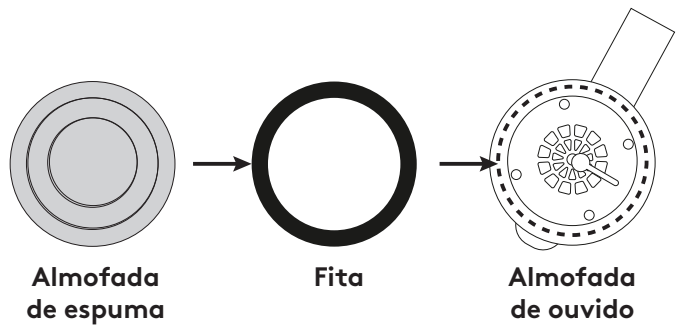

4. Segure a nova almofada do fone de ouvido, certificando-se de que os pequenos orifícios na lateral estejam alinhados com a parte superior e inferior da almofada. Ela deve estar alinhada com a porta USB C na parte inferior.

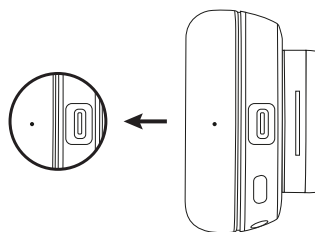

5. Começando pela parte superior, encaixe a borda da tampa do fone de ouvido dentro do espaço livre. Coloque a borda da tampa no espaço ao redor do fone de ouvido.

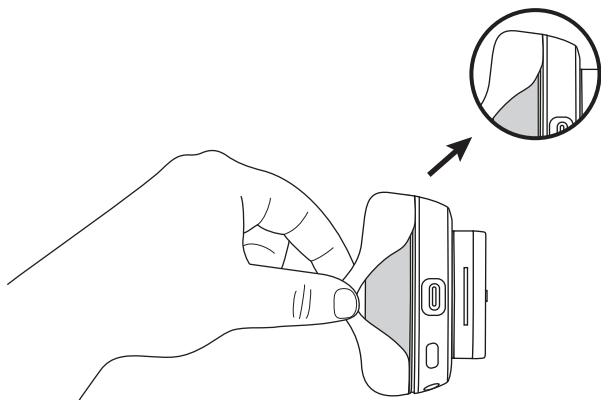

6. Depois de terminar, toque levemente no fone de ouvido várias vezes para empurrar o ar para fora.

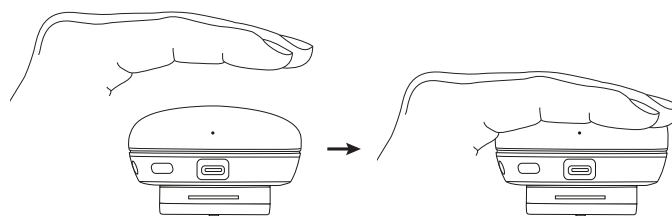

DIMENSÕES

CAPA DO FONE DE OUVIDO:

Altura x largura x profundidade:
70,7 mm x 70,7 mm x 16,4 mm

www.logitech.com/support/zone900