

# LOGITECH ZONE 900 RECEIVER

Complete Setup Guide  
Guide d'installation complet

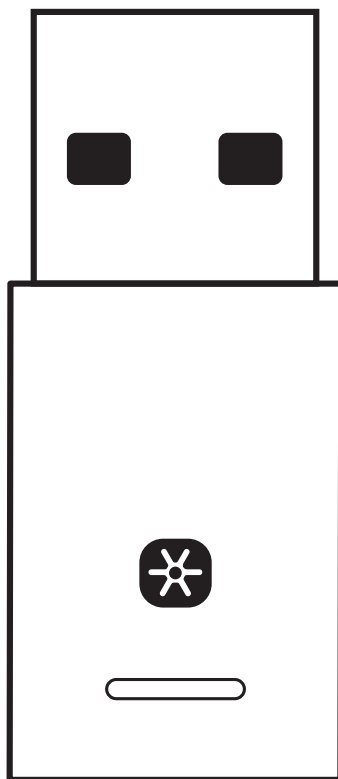

## CONTENTS

English . . . . .3

Français . . . . .7

Español . . . . . 11

Português . . . . . 15

# KNOW YOUR PRODUCT

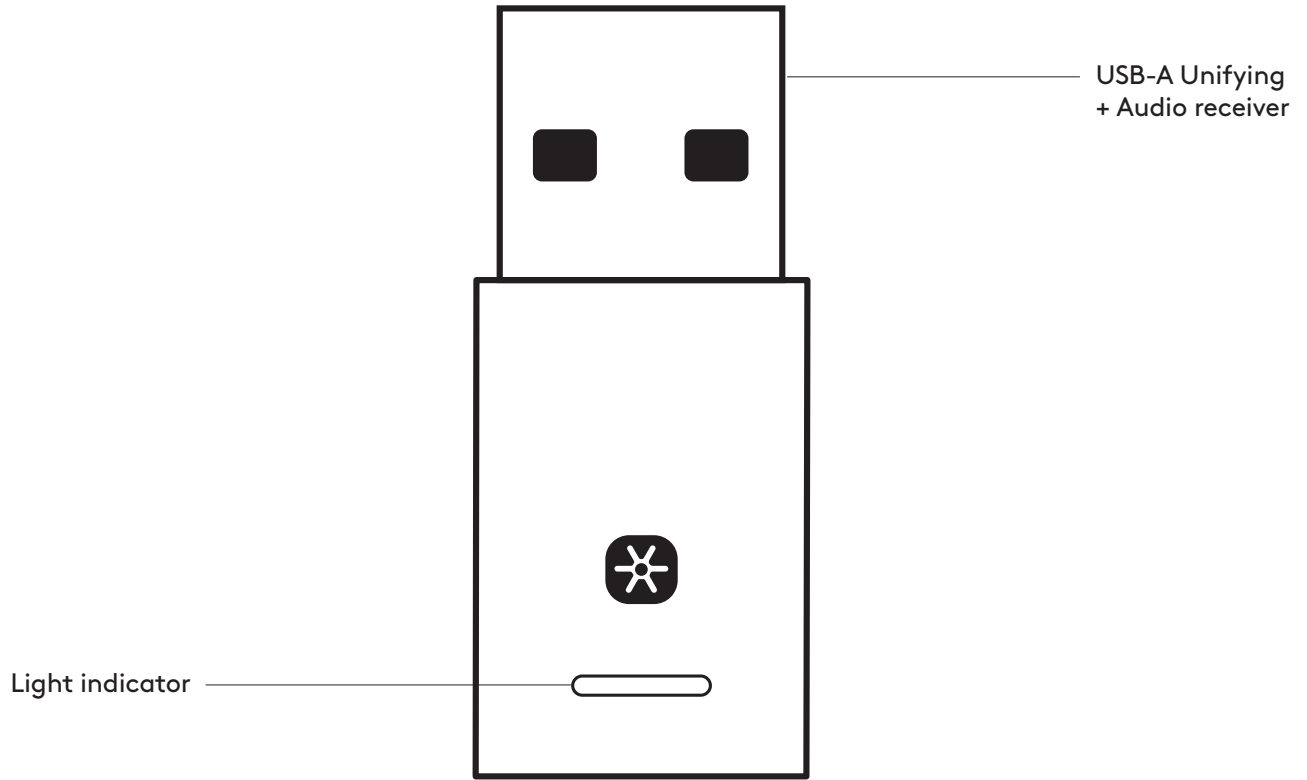

## WHAT'S IN THE BOX

USB-A Unifying + Audio receiver

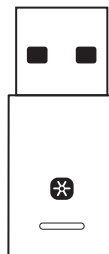

## CONNECTING THE RECEIVER TO THE HEADSET

1. Insert your Zone 900 receiver into the computer USB-A port. Or to connect it via USB-C, insert the receiver into USB-C adapter first. Then plug in the USB-C adapter into the computer USB-C port.

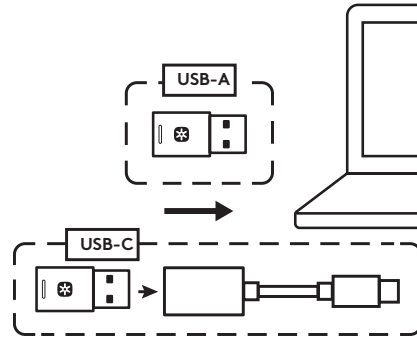

2. Install and open Logi Tune Desktop. Download it from [www.logitech.com/tune](http://www.logitech.com/tune)

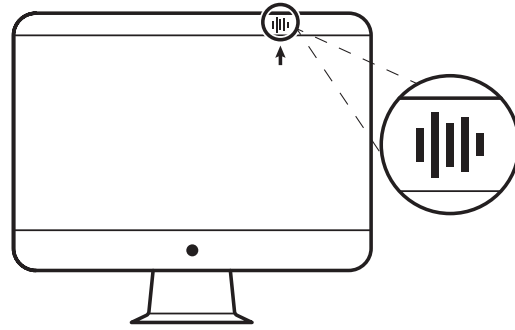

3. Logi Tune Desktop will confirm that a new receiver is found. Click **Done** to start connecting to the headset.

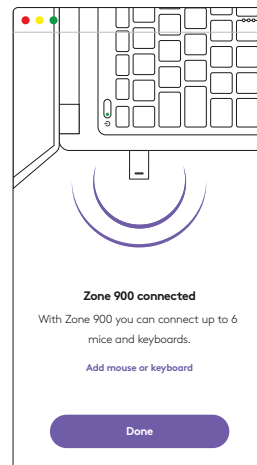

4. Enter pairing mode on headset by pressing the power button for 3 seconds. Click **Continue**.

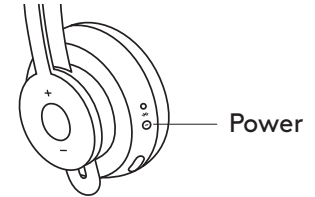
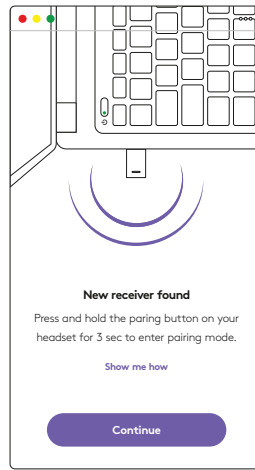

5. If pairing mode is successful, light indicators on the receiver and headset will flash white.

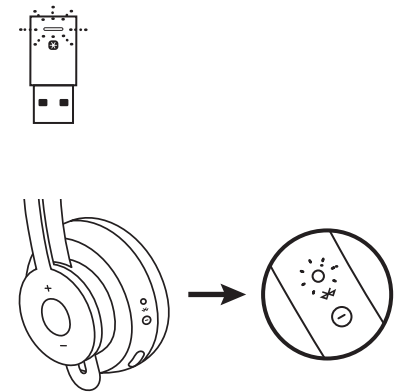
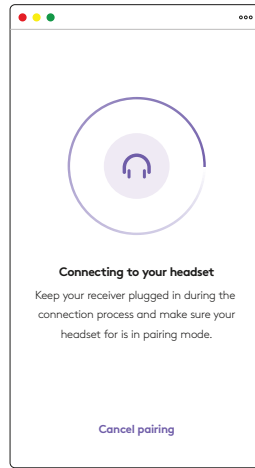

6. Once you see this screen, the receiver is now paired with the headset. Light indicators on the receiver and headset will turn solid white.

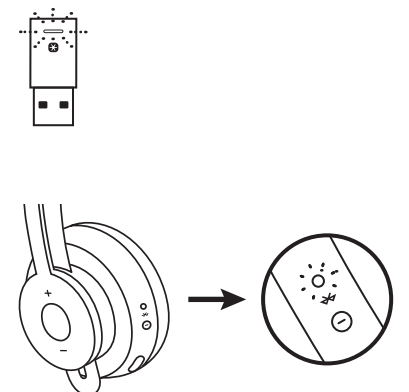
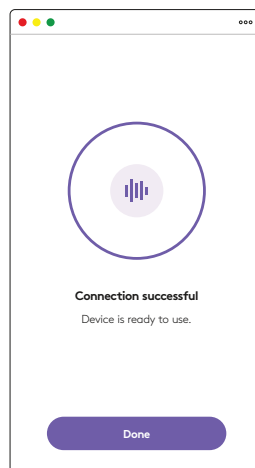

7. With Zone 900 receiver, you can pair up to 6 Logitech Unifying peripherals.
  - a. On Logi Tune Desktop, go to Settings and click **Add mouse or keyboard**.
  - b. If you already have the Unifying Software installed on your computer, it should open. If not, it will be downloaded and installed automatically.
  - c. Follow the Unifying Software prompts to complete adding your mouse and keyboard.
  - d. To add more devices, follow steps 2 and 3 and follow the steps in the Unifying Software.

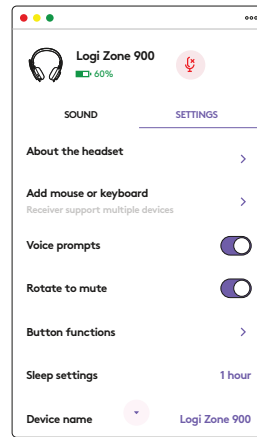

## DIMENSIONS

### RECEIVER:

Height x Width x Depth: 35.5 mm x 16.2 mm x 5.3 mm

[www.logitech.com/support/zone900](http://www.logitech.com/support/zone900)

## PRÉSENTATION DU PRODUIT

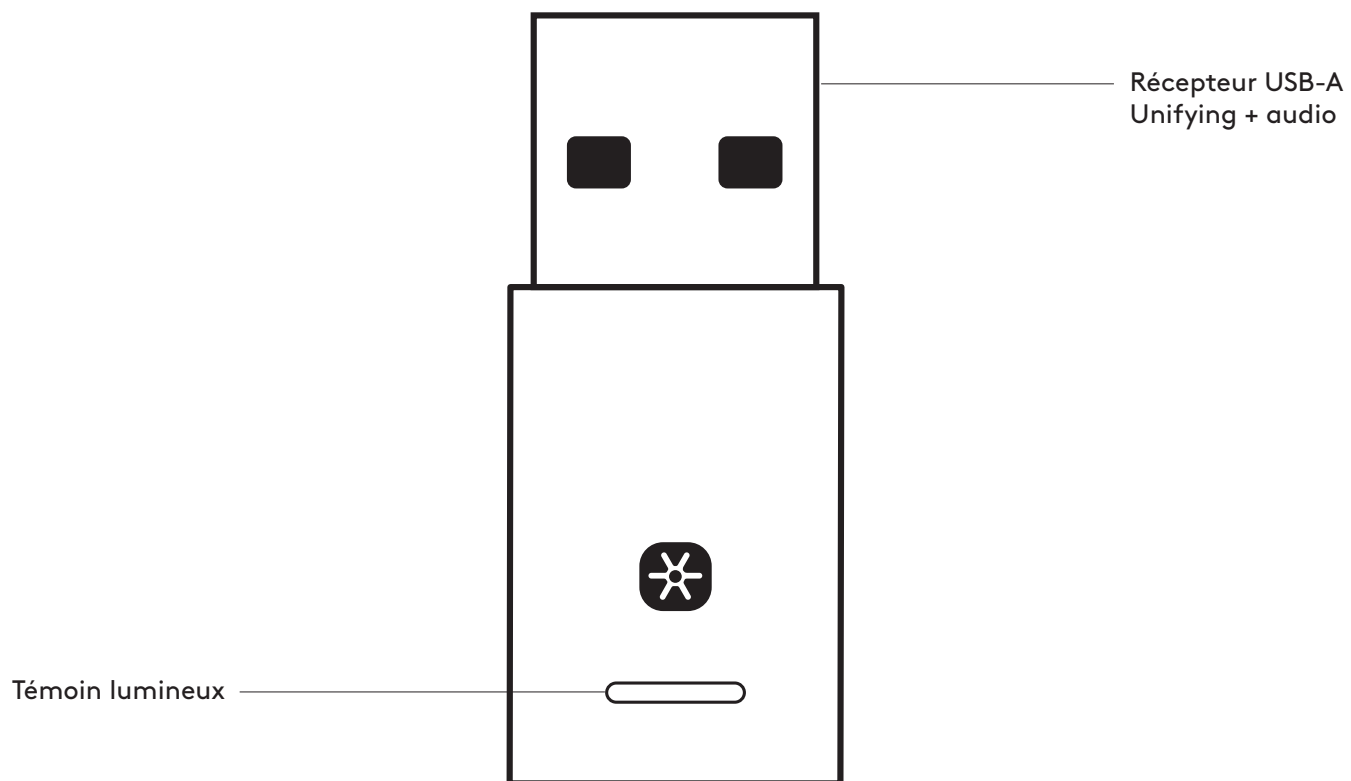

## CONTENU DU COFFRET

Récepteur USB-A Unifying + audio

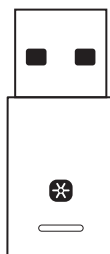

## CONNEXION DU RÉCEPTEUR AU CASQUE

1. Insérez le récepteur Zone 900 dans le port USB-A de l'ordinateur. Pour le connecter via USB-C, insérez d'abord le récepteur dans l'adaptateur USB-C. Insérez ensuite l'adaptateur USB-C dans le port USB-C de l'ordinateur.

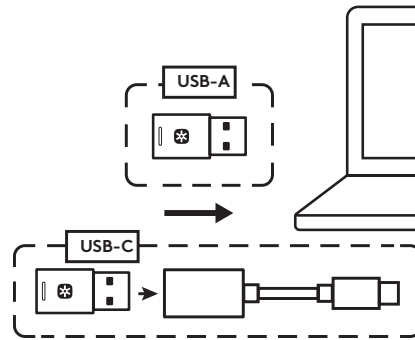

2. Installez et ouvrez Logi Tune Desktop. Téléchargez-le à l'adresse [www.logitech.com/tune](http://www.logitech.com/tune)

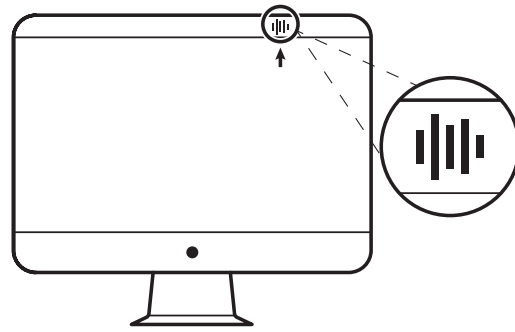

3. Logi Tune Desktop confirmera qu'un nouveau récepteur a été trouvé. Cliquez sur **Terminé** pour commencer à vous connecter au casque.

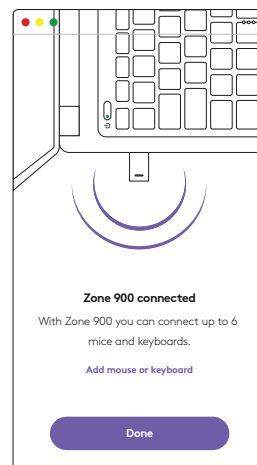



4. Accédez au mode de couplage sur le casque en appuyant sur le bouton d'alimentation pendant 3 secondes. Cliquez sur **Continuer**.

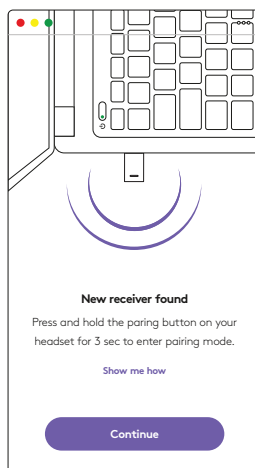

Mise sous/  
hors tension

5. Si le mode couplage réussit, les témoins lumineux du récepteur et du casque clignotent en blanc.

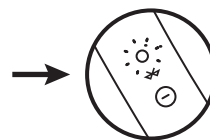
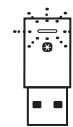
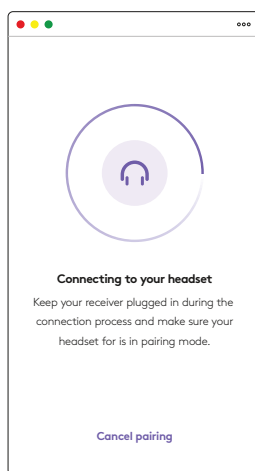

6. Une fois que vous voyez cet écran, le récepteur est maintenant couplé avec le casque. Les témoins lumineux du récepteur et du casque deviennent blancs fixes.

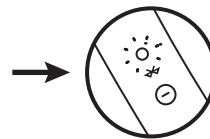
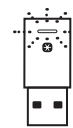
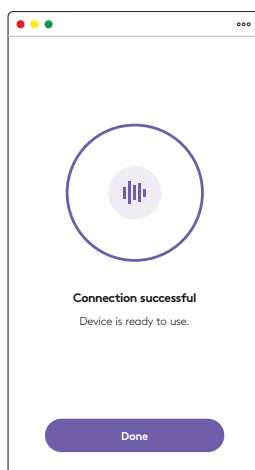

7. Avec le récepteur Zone 900, vous pouvez coupler jusqu'à 6 périphériques Logitech Unifying.
  - a. Sur Logi Tune Desktop, accédez à Paramètres et cliquez sur **Ajouter une souris ou un clavier**.
  - b. Si le logiciel Unifying est déjà installé sur votre ordinateur, il devrait s'ouvrir. Si ce n'est pas le cas, il sera téléchargé et installé automatiquement.
  - c. Suivez les invites du logiciel Unifying pour terminer l'ajout de votre souris et de votre clavier.
  - d. Pour ajouter d'autres dispositifs, suivez les étapes 2 et 3, et suivez les étapes du logiciel Unifying.

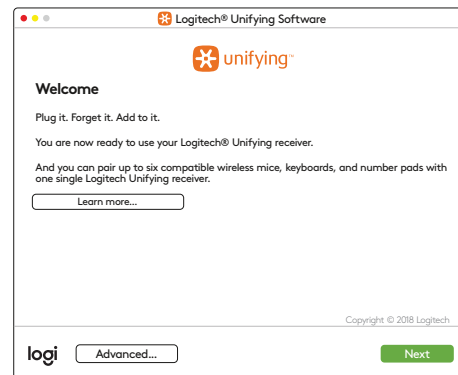
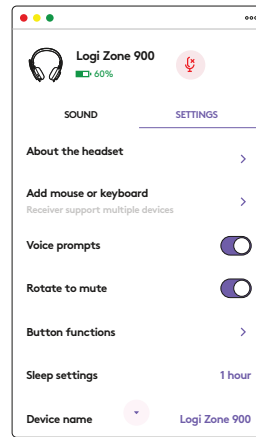

## DIMENSIONS

### RÉCEPTEUR:

Hauteur x largeur x profondeur:  
35,5 mm x 16,2 mm x 5,3 mm

[www.logitech.com/support/zone900](http://www.logitech.com/support/zone900)

## COMPONENTES DEL PRODUCTO

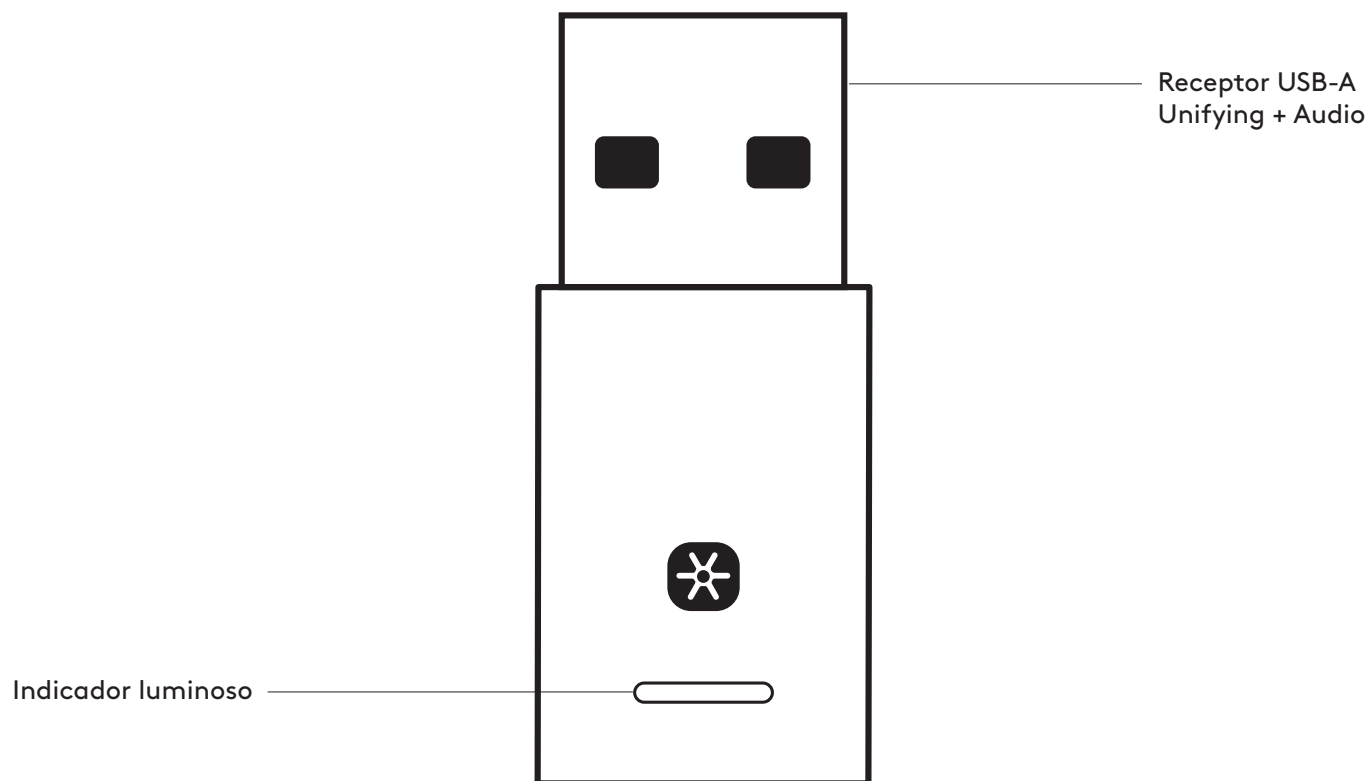

## CONTENIDO DE LA CAJA

USB-A Unifying + receptor de audio

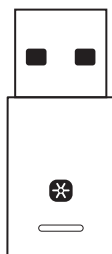

## CONECTAR EL RECEPTOR A LOS AUDÍFONOS

1. Inserta el receptor de Zone 900 en el puerto USB-A de la computadora. O establece conexión a través de USB-C, insertando primero el receptor en el adaptador USB-C. Luego inserta el adaptador USB-C al puerto USB-C de la computadora.

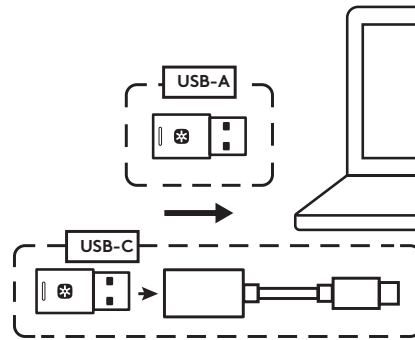

2. Instala y abre Logi Tune para escritorio. Descarga la aplicación desde [www.logitech.com/logitune](http://www.logitech.com/logitune)

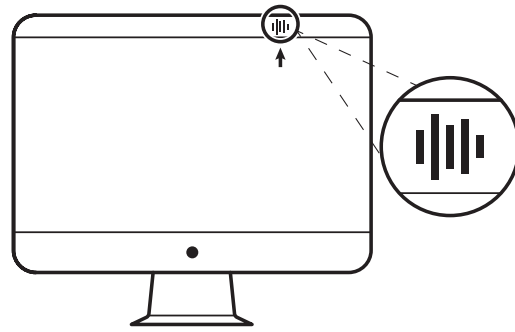

3. Logi Tune para escritorio confirmará que se encontró un nuevo receptor. Haz click en **Listo** para comenzar a conectar tus auriculares.

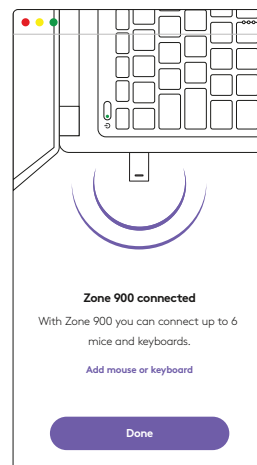

4. Entra en modo de emparejamiento en los audífonos presionando el botón de encendido por 3 segundos. Haz click en **Continuar**.

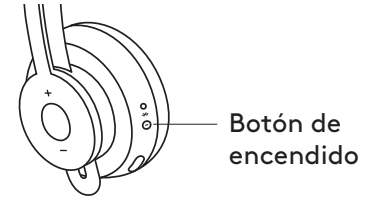
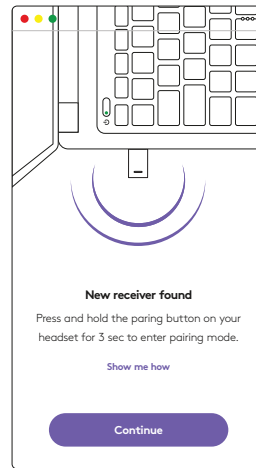

5. Si el emparejamiento es correcto, los indicadores luminosos del receptor y de los auriculares emitirán destellos blancos.

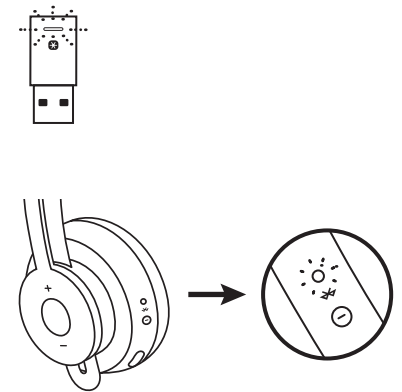
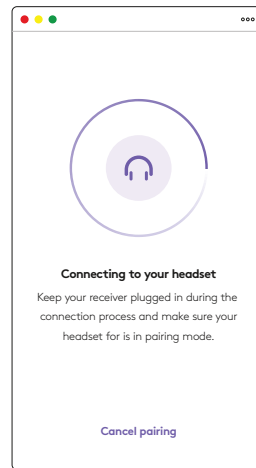

6. Cuando veas esta pantalla, el receptor estará emparejado con los auriculares. Los indicadores luminosos del receptor y de los auriculares se iluminarán con luz blanca permanente.

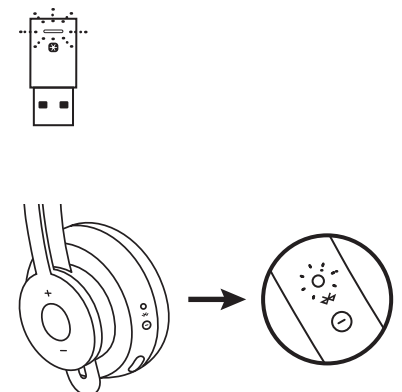
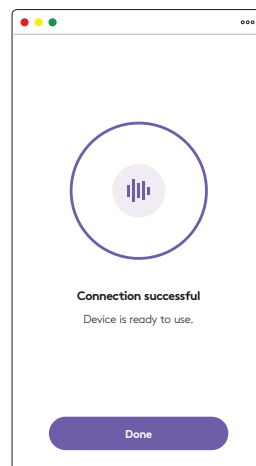

7. Con el receptor de Zone 900 puedes emparejar un máximo de seis periféricos Logitech Unifying.
- En Logi Tune para escritorio, ve a Ajustes y haz click en **Agregar mouse o teclado**.
  - Si ya tienes el software Unifying instalado en tu computadora, debería abrirse. Si no, se descargará e instalará automáticamente.
  - Sigue las indicaciones del software Unifying para completar la adición del mouse y el teclado.
  - Para agregar más dispositivos, sigue los pasos 2 y 3, y luego sigue los pasos en el software Unifying.

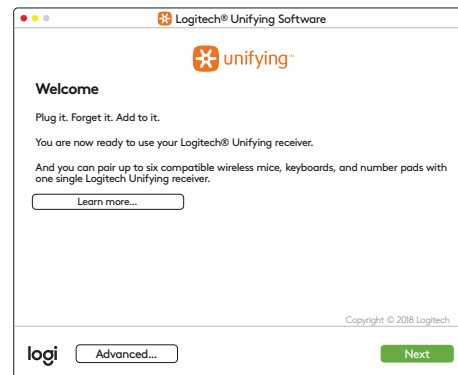
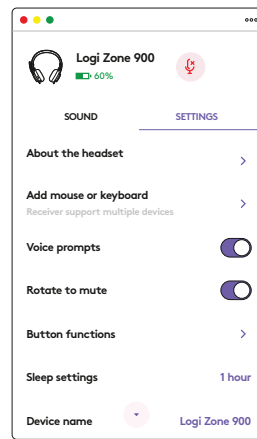

## DIMENSIONES

### RECEPTOR:

Altura x Anchura x Profundidad:  
35,5 mm x 16,2 mm x 5,3 mm

[www.logitech.com/support/zone900](http://www.logitech.com/support/zone900)

## CONHECER O PRODUTO

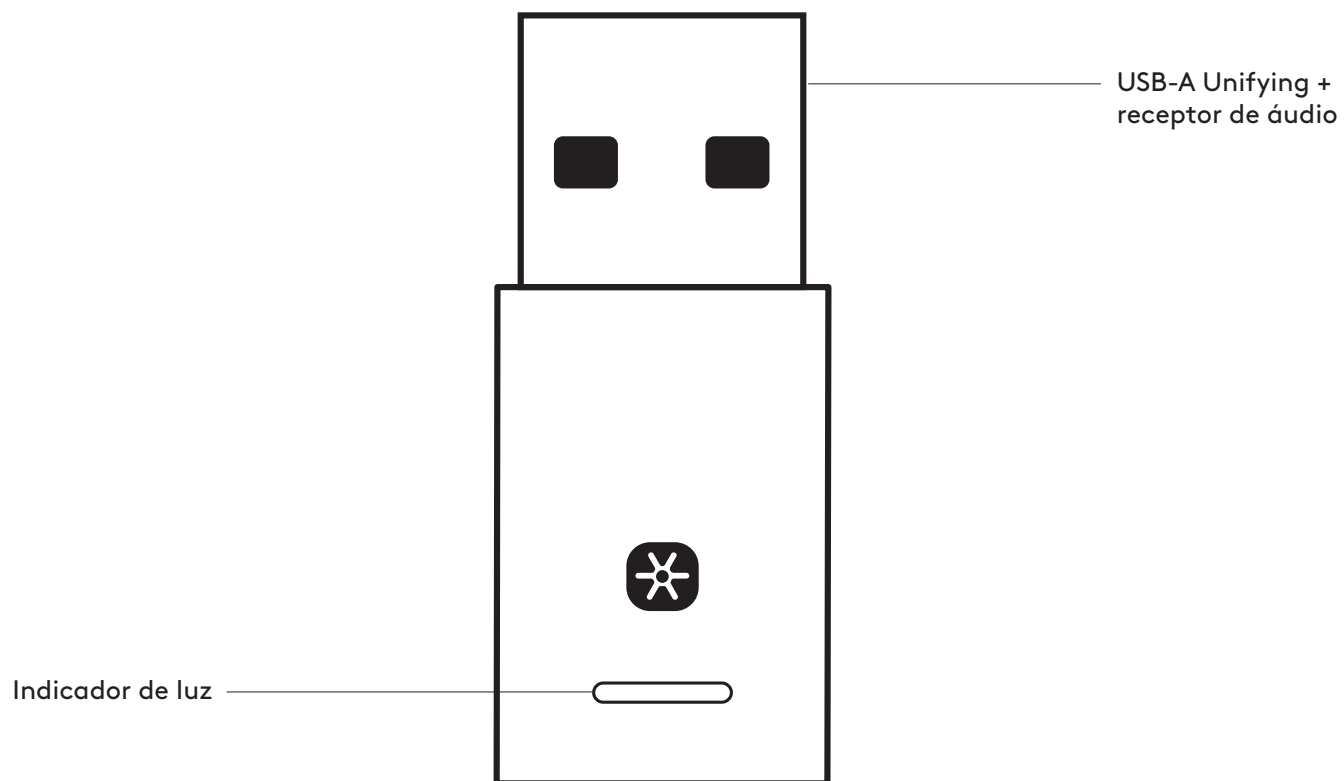

## ITENS INCLUÍDOS NA EMBALAGEM

USB-A Unifying + receptor de áudio

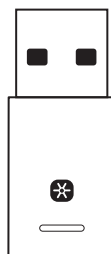

## CONEXÃO DO RECEPTOR AO HEADSET

1. Insira o receptor Zone 900 na porta USB-A do computador. Ou para conectá-lo via USB-C, insira primeiro o receptor no adaptador USB-C. Em seguida, conecte o adaptador USB-C na porta USB-C do computador.

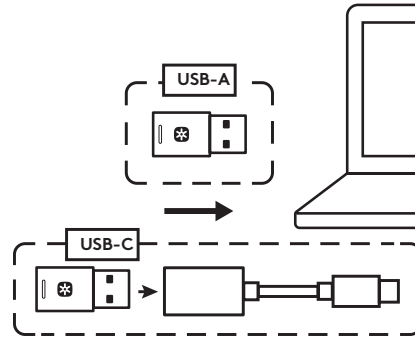

2. Instale e abra o Logi Tune Desktop. Faça o download em [www.logitech.com/logitune](http://www.logitech.com/logitune)

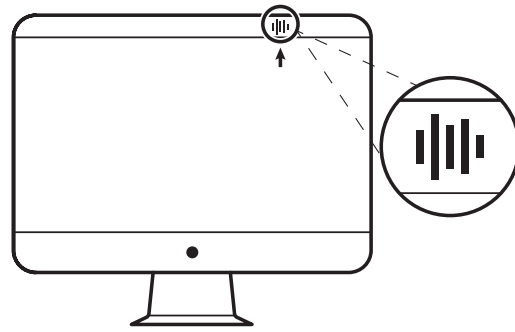

3. O Logi Tune Desktop confirmará que um novo receptor foi encontrado. Clique **Concluído** para começar a conectar ao headset.

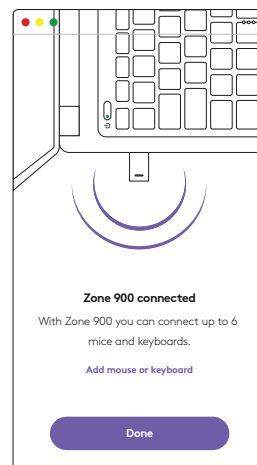



4. Entre no modo de pareamento no headset pressionando o botão liga/desliga por 3 segundos. Clique em **Continuar**.

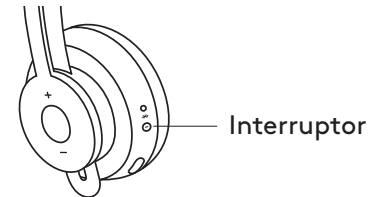
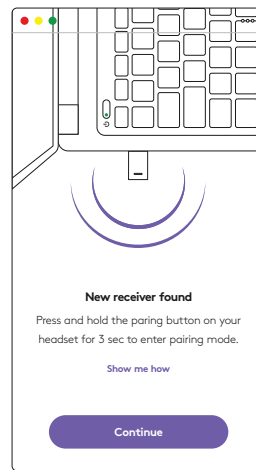

5. Se o modo de pareamento for bem sucedido, os indicadores luminosos no receptor e no headset piscarão em branco.

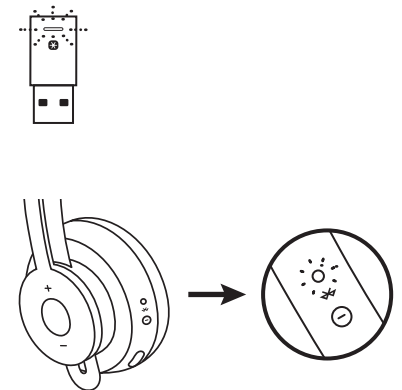
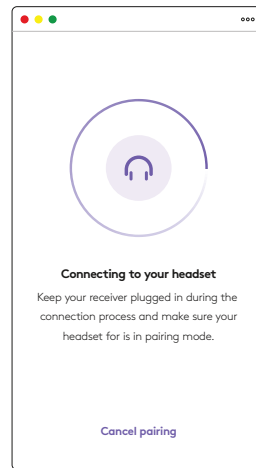

6. Depois de ver esta tela, o receptor estará pareado com o headset. Os indicadores luminosos no receptor e no headset ficarão brancos sólidos.

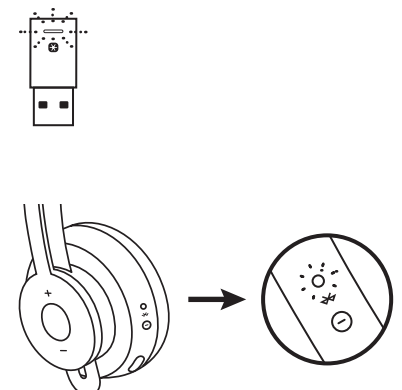
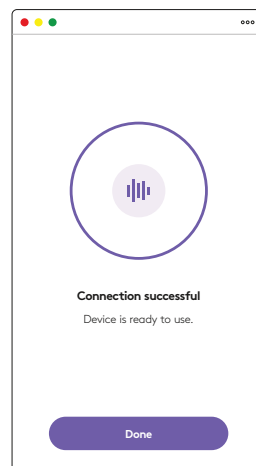

7. Com o receptor Zone 900, você pode parear até 900 periféricos Logitech Unifying.
  - a. No Logi Tune Desktop, vá para Configurações e clique em **Adicionar mouse ou teclado**.
  - b. Se você já possui o Software Unifying instalado no seu computador, ele deve abrir. Caso contrário, ele será baixado e instalado automaticamente.
  - c. Siga as instruções do Software Unifying para completar o adição do seu mouse e teclado.
  - d. Para adicionar mais dispositivos, siga as etapas 2 e 3 e siga as etapas no Software Unifying.

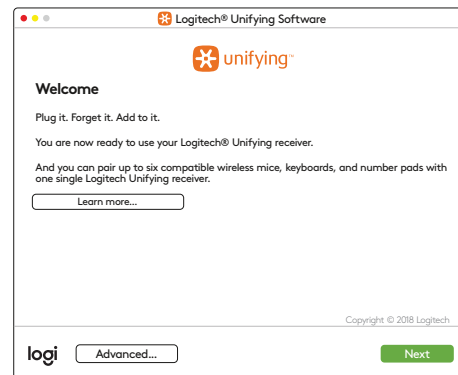
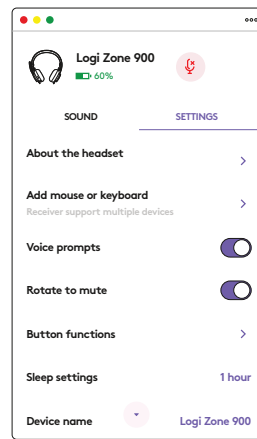

## DIMENSÕES

### RECEPTOR:

Altura x largura x profundidade:  
35,5 mm x 16,2 mm x 5,3 mm

[www.logitech.com/support/zone900](http://www.logitech.com/support/zone900)