

C920X PRO HD WEBCAM

Complete Setup Guide

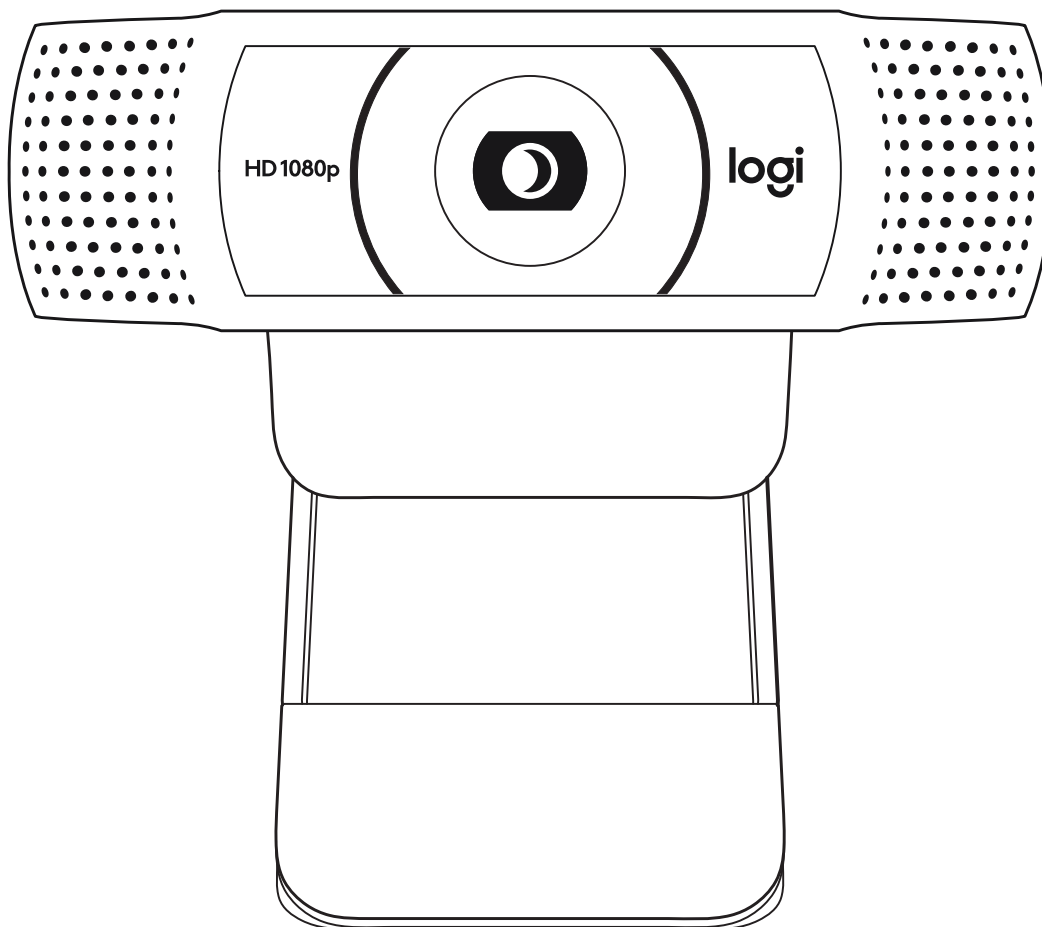

logitech®

CONTENTS

English	3	Slovenčina	67
Deutsch	7	Українська.	71
Français	11	Eesti	75
Italiano	15	Latviski	79
Español.	19	Lietuvių	83
Português	23	Български	87
Nederlands	27	Hrvatski	91
Svenska.	31	Srpski	95
Dansk.	35	Slovenščina	99
Norsk	39	Română	103
Suomi.	43	Türkçe	107
Ελληνικά.	47	111	العربية
По-руски	51	115	עברית
Po polsku	55	繁體中文	119
Magyar	59	한국어	123
Česká verze.	63	Indonesia	127

KNOW YOUR PRODUCT

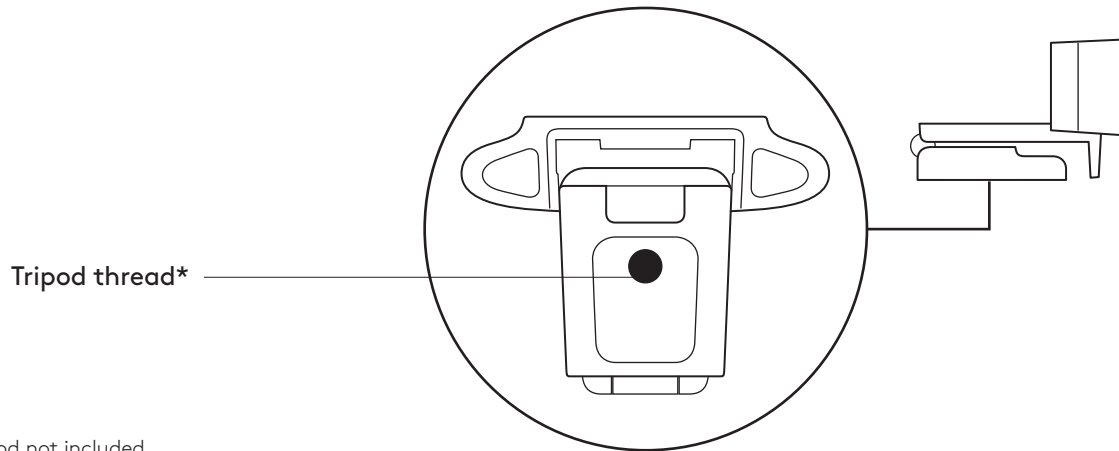
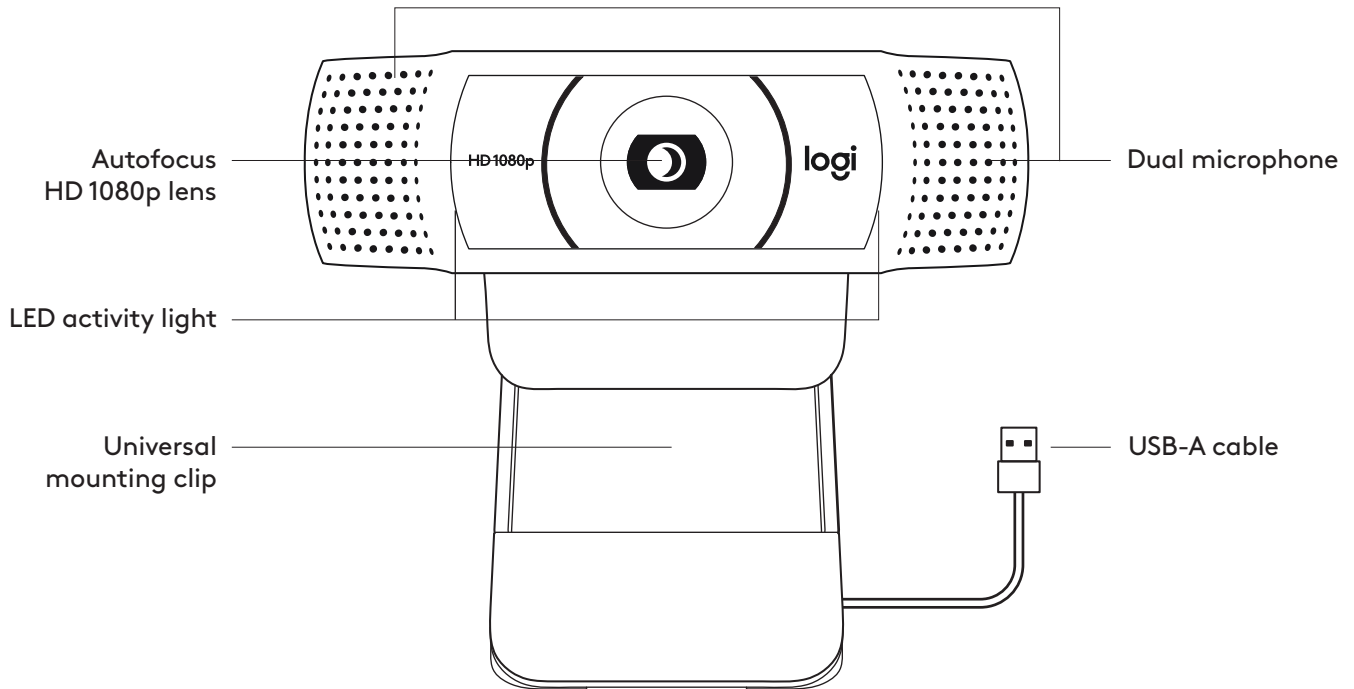

* Tripod not included

WHAT'S IN THE BOX

- 1 Webcam with 5 ft (1.5 m) attached USB-A cable
- 2 XSplit license coupon
- 3 User documentation

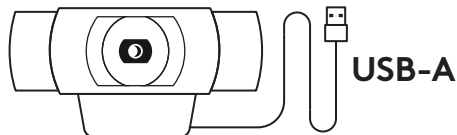

SETTING UP THE WEBCAM

For placement on a monitor

- 1 Place your webcam on a computer, laptop or monitor at a position or angle you desire.



- 2 Adjust the webcam to make sure the foot on the universal mounting clip is flush with the back of your device.



- 3 Manually adjust the webcam up/down to the best position to frame yourself.

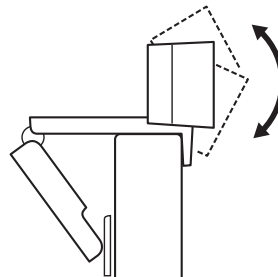

For placement on a tripod*

- 1 Locate the ¼ inch tripod thread on the bottom of the universal mounting clip.

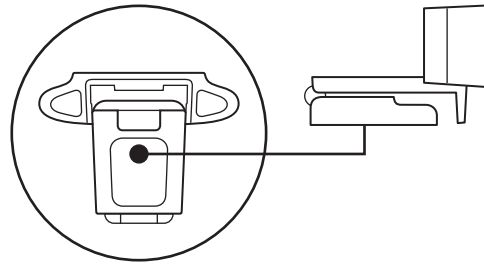

- 2 Secure the webcam on your tripod by twisting it into the ¼ inch thread.

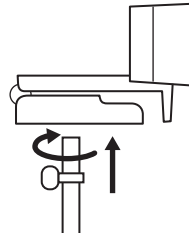

- 3 Place your webcam with the tripod anywhere you desire to the best position to frame yourself.

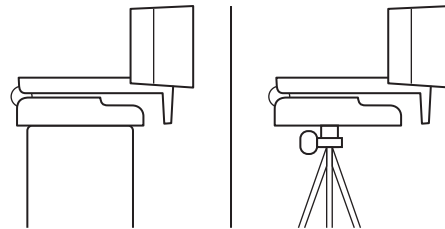

* Tripod not included

CONNECTING THE WEBCAM VIA USB-A

Plug the USB-A connector into the USB-A port on your computer.

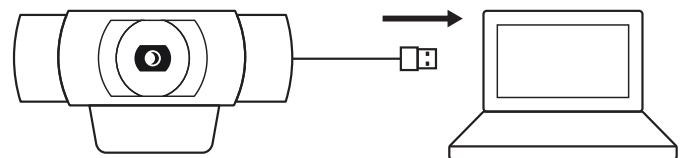

SUCCESSFUL CONNECTION

LED activity light will light up when the webcam is in use by an application.

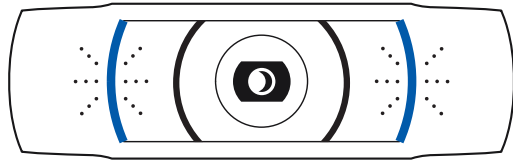

DIMENSIONS

INCLUDING FIXED MOUNTING CLIP:

Height x Width x Depth:
1.70 in (43.3 mm) x 3.70 in (94 mm) x 2.80 in (71 mm)

Cable Length: 5 ft (1.5 m)

Weight: 5.71 oz (162 g)

www.logitech.com/support/C920X

PRODUKT AUF EINEN BLICK

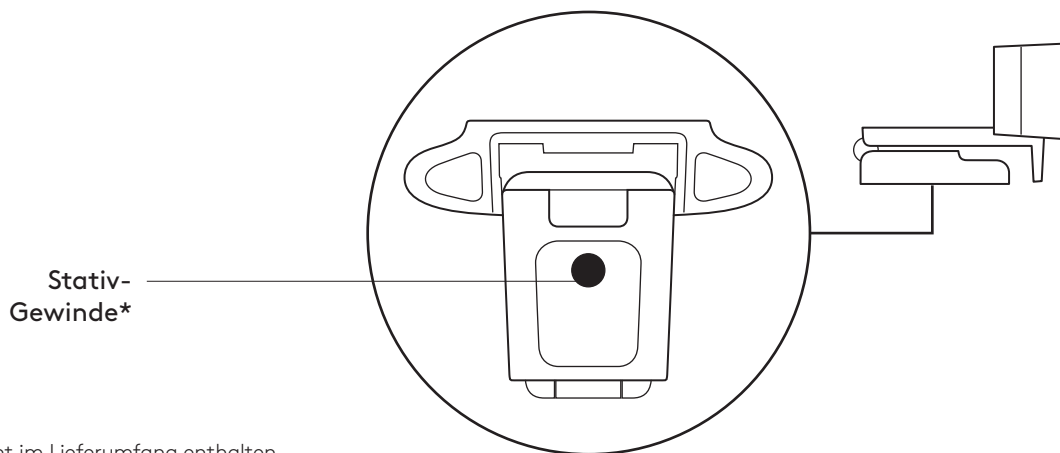
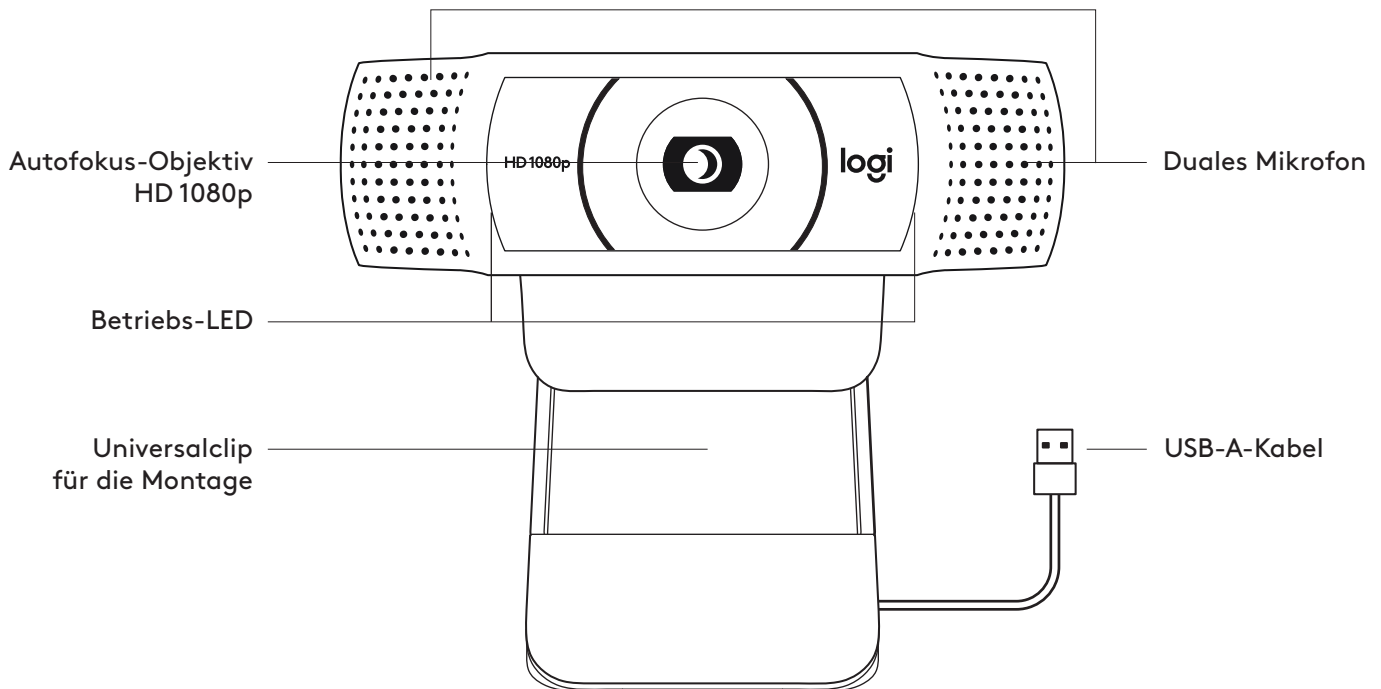

* Stativ nicht im Lieferumfang enthalten

INHALT

- 1 Webcam mit fest angebrachtem USB-A-Kabel 1,5 m
- 2 XSplit-Lizenzgutschein
- 3 Bedienungsanleitung

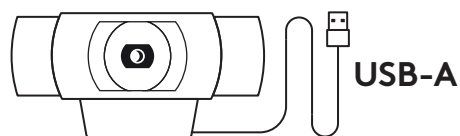

EINRICHTEN DER WEBCAM

Befestigung am Bildschirm

- 1 Die Webcam lässt sich in jeder gewünschten Position und in beliebigem Winkel am Computer, Notebook oder Monitor anbringen.



- 2 Passen Sie sie so an, dass der Fuß der Universalklemme bündig mit der Rückseite Ihres Geräts abschließt.

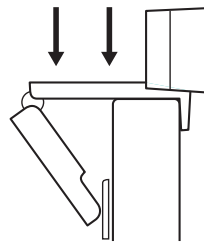

- 3 Richten Sie die Webcam manuell höher oder tiefer aus, bis Sie optimal im Bild sind.

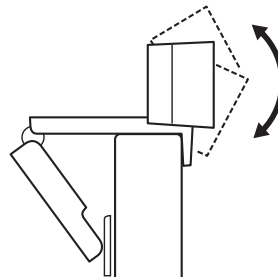

Befestigung auf einem Stativ*

- 1 Suchen Sie das ¼-Zoll-Stativgewinde auf der Unterseite der Universalklemme.

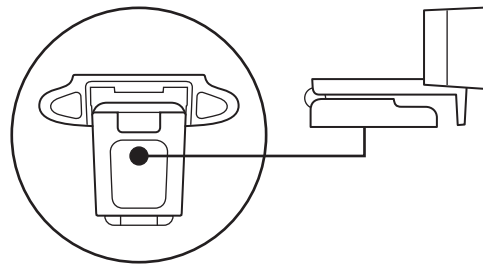

- 2 Schrauben Sie die Webcam auf das Gewinde, um sie zu befestigen.

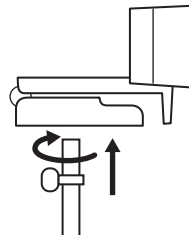

- 3 Platzieren Sie die Webcam mit dem Stativ an der für Sie optimalen Position.

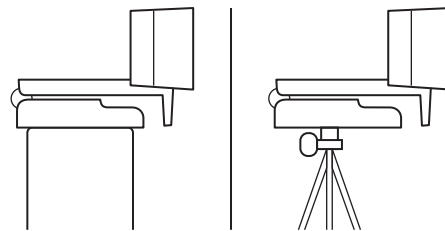

* Stativ nicht im Lieferumfang enthalten

ANSCHLIESSEN DER WEBCAM ÜBER USB-A

Schließen Sie den USB-A-Stecker an einen USB-A-Anschluss Ihres Computers an.

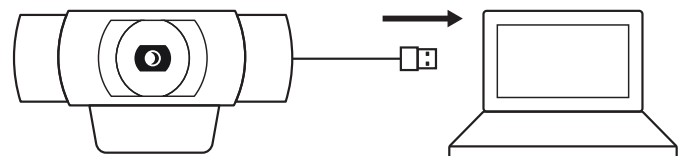

VERBINDUNG ERFOLGREICH

Wenn die Webcam von einer Anwendung genutzt wird, leuchtet die Aktivitäts-LED auf.

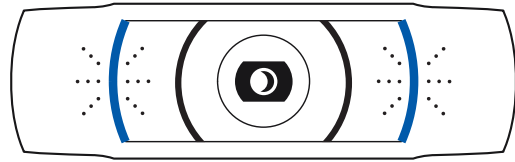

ABMESSUNGEN

EINSCHLIESSLICH FESTER MONTAGECLIP:

Höhe x Breite x Tiefe:
43.3 mm x 94 mm x 71 mm

Kabellänge: 1,5 m (5 Fuß)

Gewicht: 162 g

www.logitech.com/support/C920X

PRÉSENTATION DU PRODUIT

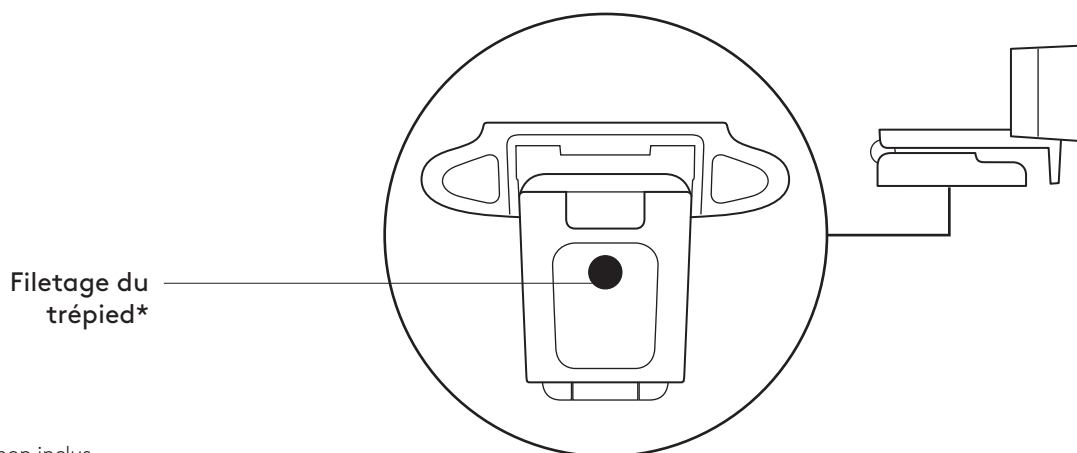
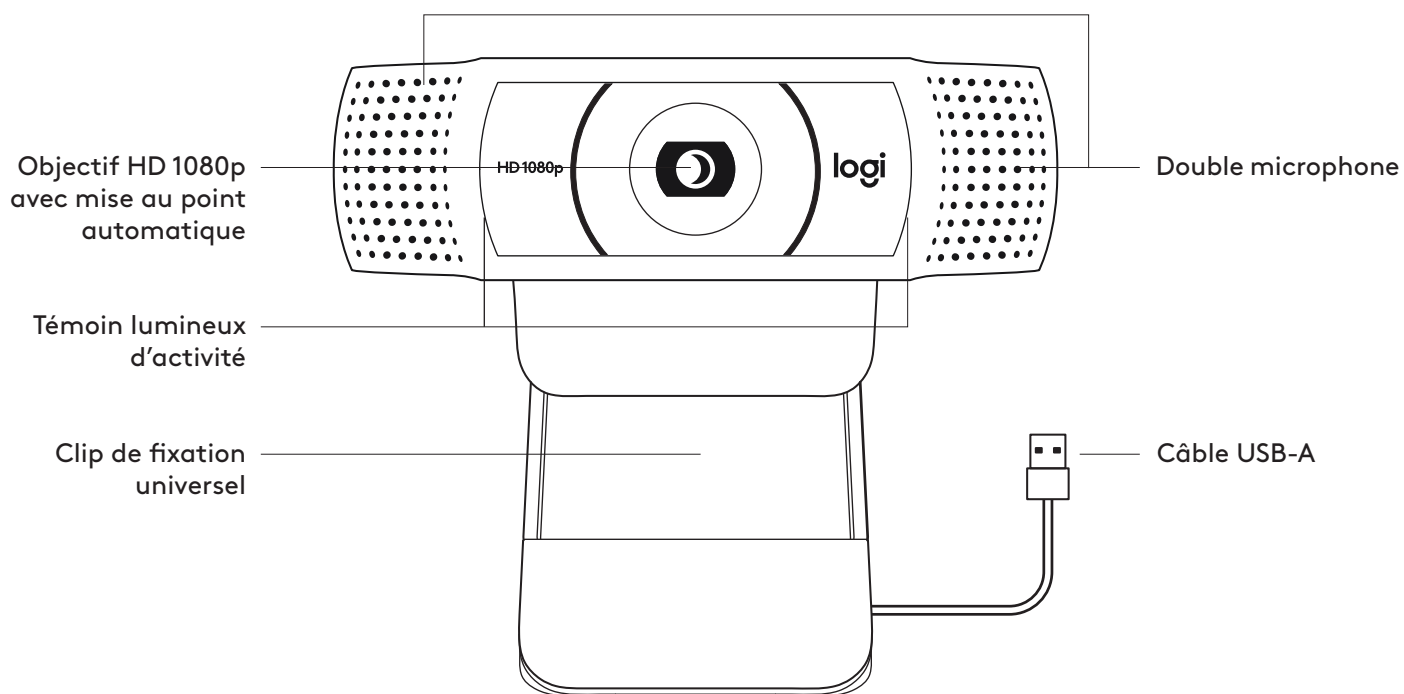

* Trépied non inclus

CONTENU

- 1 Webcam avec câble USB-A de 1,5 m (5 pieds) joint
- 2 Coupon de licence XSplit
- 3 Documentation utilisateur

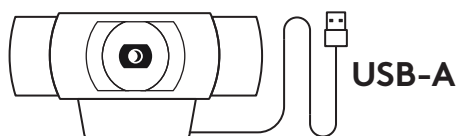

INSTALLATION DE LA WEBCAM

Fixation sur un écran

- 1 Placez votre webcam sur un ordinateur, un ordinateur portable ou un écran à l'angle ou dans la position de votre choix.



- 2 Ajustez la webcam pour vous assurer que le pied du clip de fixation universel est aligné avec l'arrière de votre dispositif.



- 3 Ajustez manuellement la webcam vers le haut/bas pour vous cadrer au mieux.

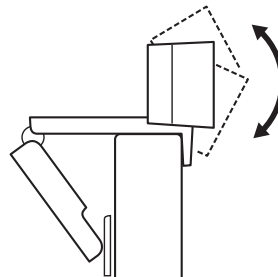

Fixation sur un trépied*

- 1 Recherchez le filetage du trépied de ¼ pouce sous le clip de montage universel.

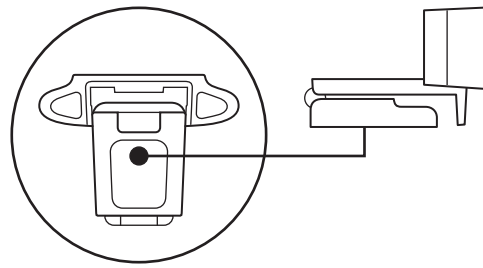

- 2 Sécurisez la webcam sur le trépied en la vissant sur le filetage ¼ pouce.

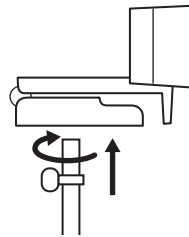

- 3 Placez votre webcam sur le trépied selon votre convenance dans la meilleure position pour vous cadrer.

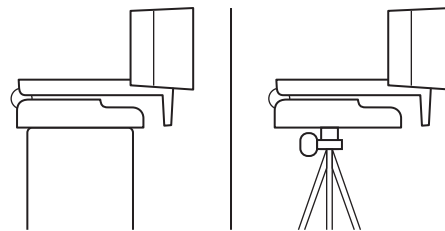

* Trépied non inclus

CONNEXION DE LA WEBCAM VIA USB-A

Branchez le connecteur USB-A sur le port USB-A de votre ordinateur.

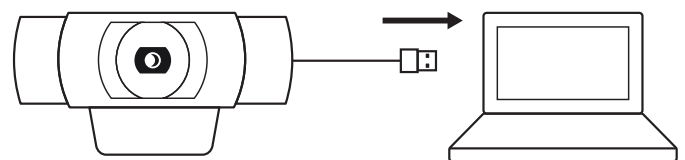

CONNEXION RÉUSSIE

Le témoin lumineux d'activité s'allumera lorsque la webcam est utilisée par une application.

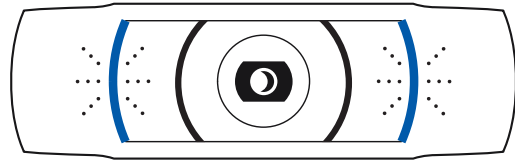

DIMENSIONS

AVEC LE CLIP DE FIXATION UNIVERSEL:

Hauteur x largeur x profondeur:

43,3 mm (1,70 pouce) x 94 mm (3,70 pouces) x 71 mm (2,80 pouces)

Longueur du câble: 1,5 m (5 pieds)

Poids : 162 g (5,71 onces)

www.logitech.com/support/C920X

PANORAMICA DEL PRODOTTO

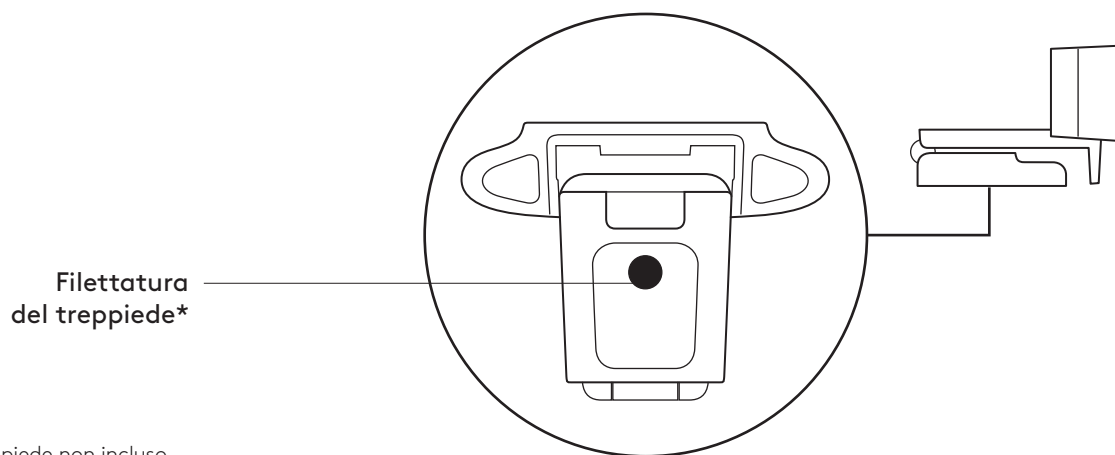
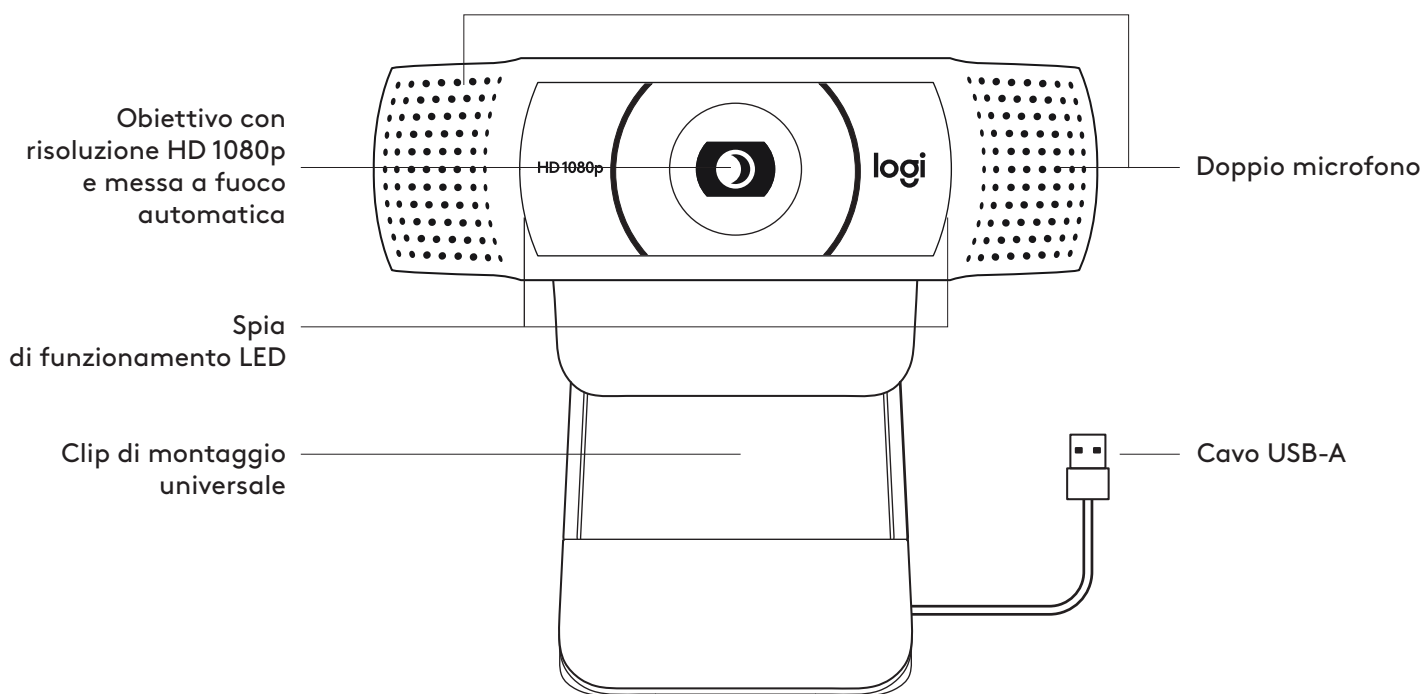

* Treppiede non incluso.

CONTENUTO DELLA CONFEZIONE

- 1 Webcam con cavo USB-A da 1,5 m (5 piedi) collegato
- 2 Buono per licenza XSplit
- 3 Documentazione per l'utente

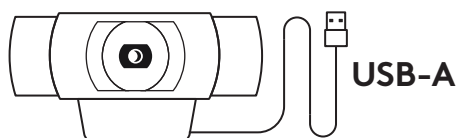

CONFIGURAZIONE DELLA WEBCAM

Posizionamento sul monitor

- 1 Posiziona la tua webcam su un computer, laptop o monitor nella posizione o angolazione desiderata.



- 2 Regola la webcam per assicurarti che il piede sulla clip di montaggio universale sia allineata con il retro del dispositivo.

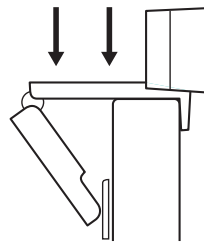

- 3 Regola manualmente la webcam verso l'alto e il basso in modo da inquadrarti al meglio.

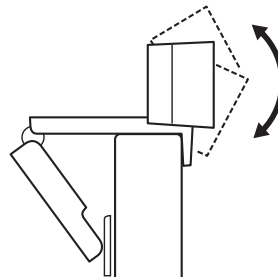

Per posizionamento su treppiede*

- 1 Individua la parte con filettatura da $\frac{1}{4}$ di pollice nella parte inferiore della clip di montaggio universale.

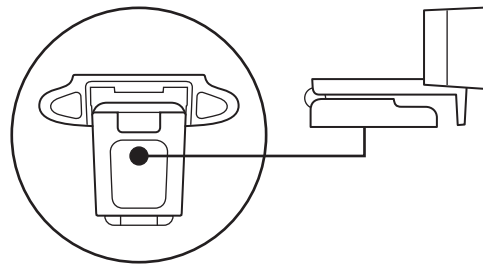

- 2 Fissa la webcam sul treppiede avvitando la parte con filettatura da $\frac{1}{4}$ di pollice.

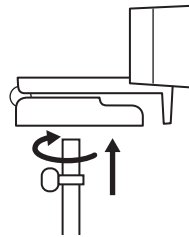

- 3 Posiziona la webcam e il treppiede dove preferisci, in modo da garantire l'inquadratura ideale.

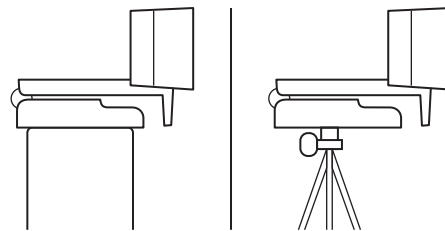

* Treppiede non incluso

CONNESSIONE DELLA WEBCAM TRAMITE USB-A

Collega il connettore USB-A a una porta USB-A del computer.

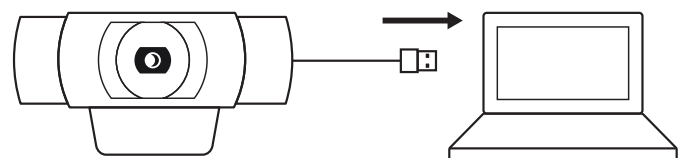

CONNESSIONE RIUSCITA

La spia di funzionamento LED si accende quando la webcam è usata da un'applicazione.

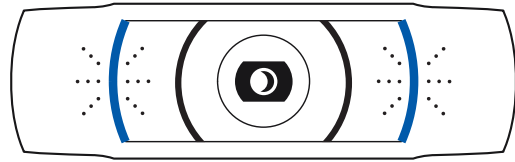

DIMENSIONI

INCLUSA CLIP DI MONTAGGIO FISSA:

Altezza x larghezza x profondità:

43,3 mm (1,70 pollici) x 94 mm (3,70 pollici) x 71 mm (2,80 pollici)

Lunghezza cavo: 1,5 m (5 piedi)

Peso: 162 g (5,71 once)

www.logitech.com/support/C920X

COMPONENTES DEL PRODUCTO

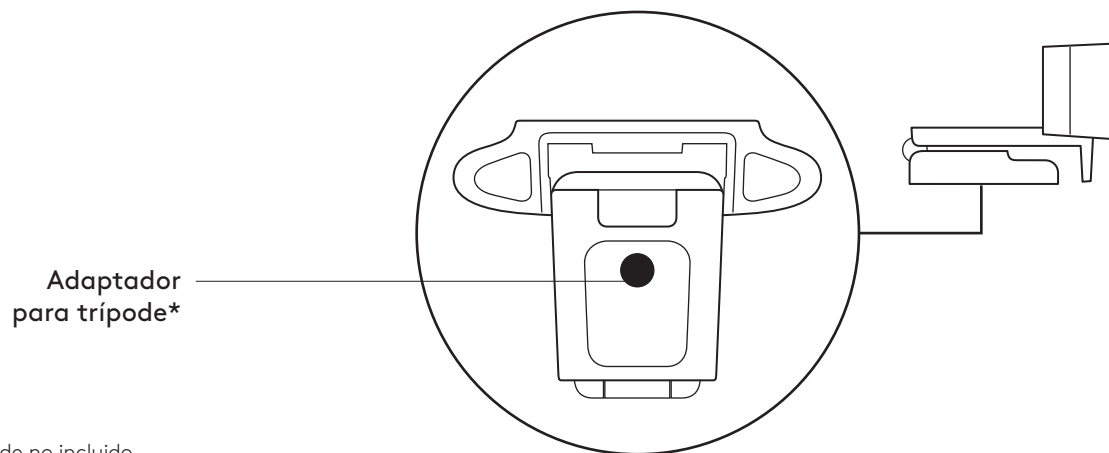
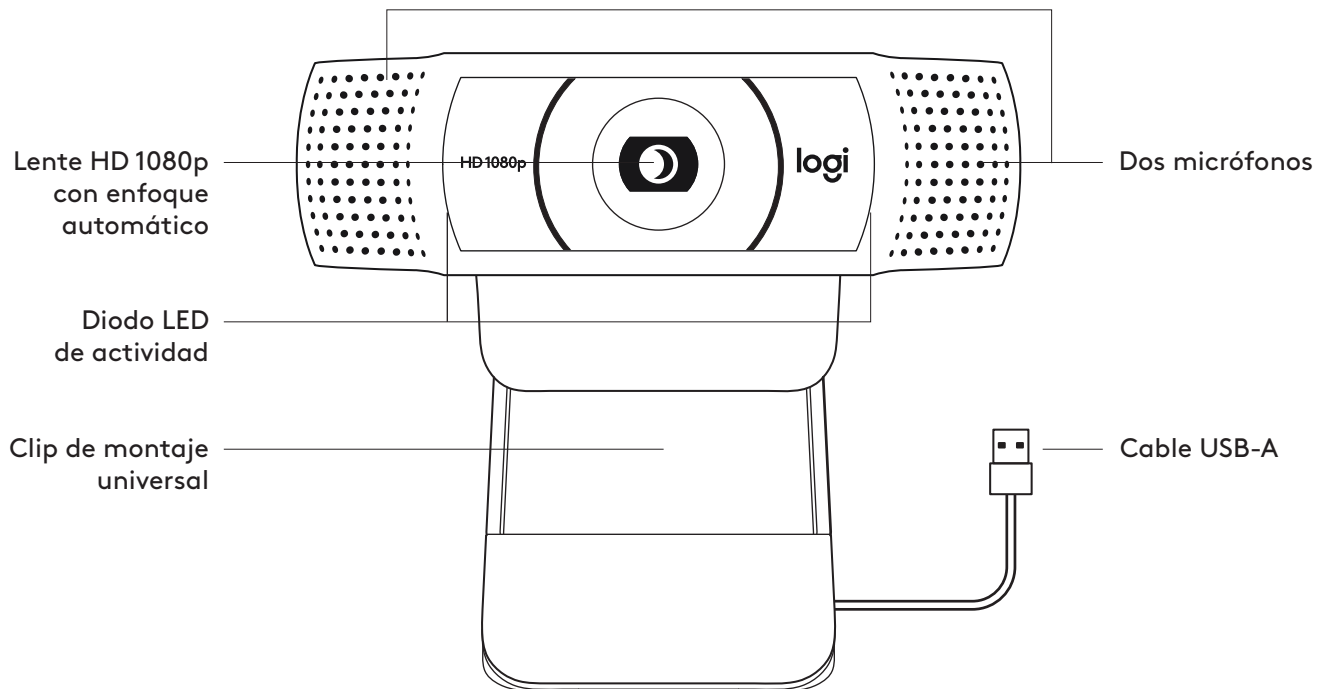

* Trípode no incluido

CONTENIDO DE LA CAJA

- 1 Cámara Web con cable USB-A fijo de 1,5 m (5 ft)
- 2 Cupón de licencia de XSplit
- 3 Documentación del usuario

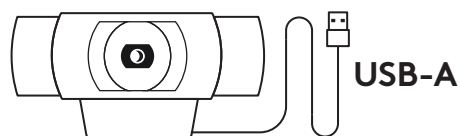

INSTALACIÓN DE LA CÁMARA WEB

Para la colocación en un monitor

- 1 Coloca la cámara Web sobre un ordenador de sobremesa, un portátil o un monitor, en la posición o el ángulo que quieras.



- 2 Ajusta la cámara de modo que el clip de montaje universal quede al ras de la parte posterior del dispositivo.



- 3 Inclina manualmente la cámara hacia arriba o hacia abajo, del modo más adecuado para encuadrarte en la imagen.

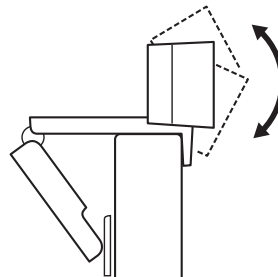

Para la colocación en un trípode*

- 1 Localiza el adaptador para trípode de ¼ de pulgada, situado en la base del clip de montaje universal.

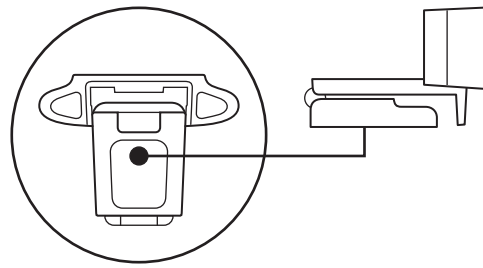

- 2 Fija la cámara Web al trípode, girándolo en el adaptador de ¼ de pulgada.

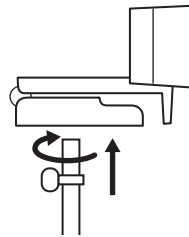

- 3 Coloca la cámara Web con el trípode en el sitio que quieras para lograr la mejor posición para encuadrarte perfectamente.

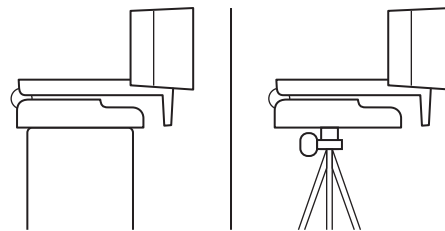

* Trípode no incluido

CONEXIÓN DE LA CÁMARA WEB POR USB-A

Conecta el cable USB-A al puerto USB-A del ordenador.

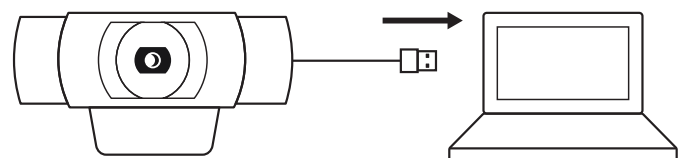

CONEXIÓN REALIZADA CORRECTAMENTE

El LED de actividad se iluminará cuando la cámara se esté usando en una aplicación.

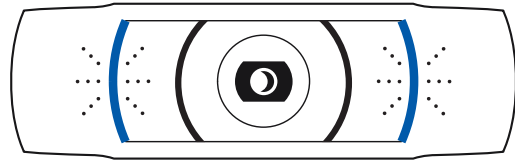

DIMENSIONES

CON CLIP DE MONTAJE ACOPLADO:

Altura x Anchura x Profundidad:

43,3 mm (1,70 in) x 94 mm (3,70 in) x 71 mm (2,80 in)

Longitud del cable: 1,5 m (5 ft)

Peso: 162 g (5,71 oz)

www.logitech.com/support/C920X

CONHEÇA O SEU PRODUTO

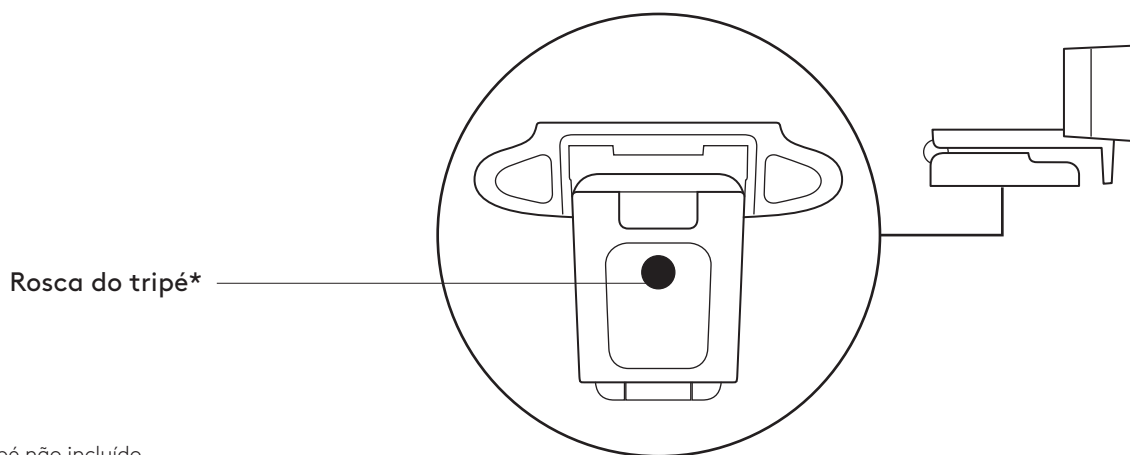
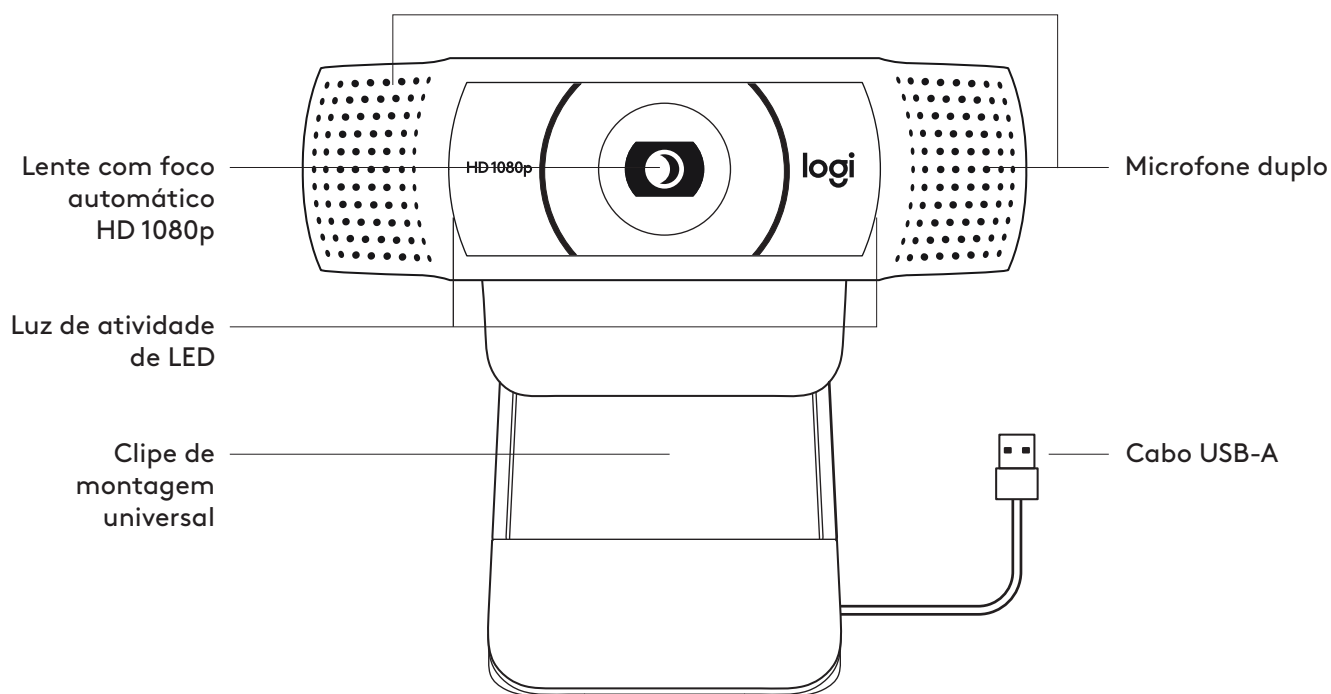

* Tripé não incluído

O QUE A CAIXA CONTÉM

- 1 Webcam com cabo USB-A anexo de 1,5 m
- 2 Cupom de licença XSplit
- 3 Documentação do usuário

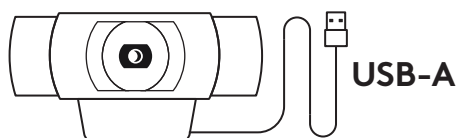

INSTALAÇÃO DA WEBCAM

Para posicionamento em um monitor

- 1 Posicione a webcam no computador, laptop ou monitor na posição ou ângulo desejado.



- 2 Ajuste a webcam para garantir que o pé do clipe de montagem universal esteja alinhado com a parte de trás do dispositivo.

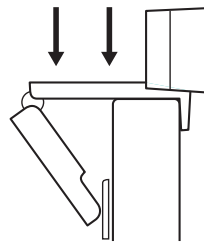

- 3 Ajuste manualmente a webcam para cima/baixo à melhor posição para se enquadrar.

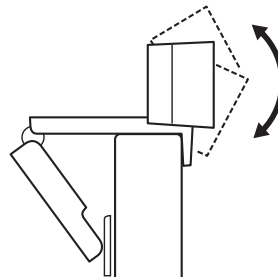

Para posicionamento em um tripé*

- 1 Localize a rosca do tripé de $\frac{1}{4}$ de polegada na parte inferior do clipe de montagem universal.

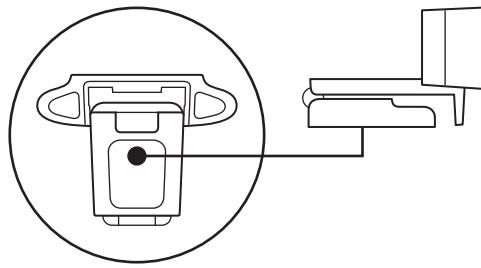

- 2 Prenda a webcam no seu tripé girando o tripé na rosca de $\frac{1}{4}$ de polegada.

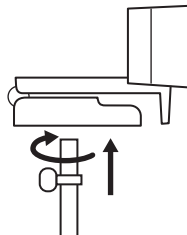

- 3 Coloque sua webcam com o tripé em qualquer lugar que desejar, na melhor posição para se enquadrar.

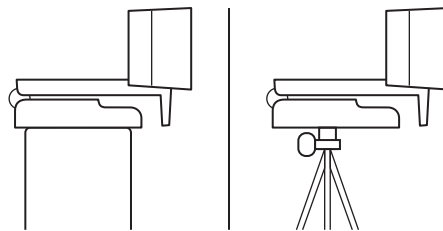

* Tripé não incluído

CONECTANDO A WEBCAM VIA USB-A

Conecte o conector USB-A na porta USB-A do seu computador.

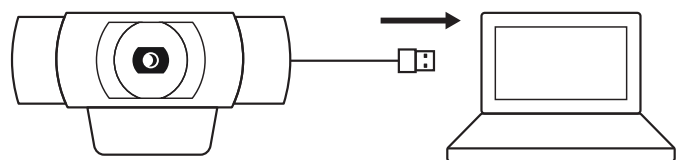

CONEXÃO BEM-SUCEDIDA

A luz LED de atividade acenderá quando a webcam estiver sendo usada por um aplicativo.

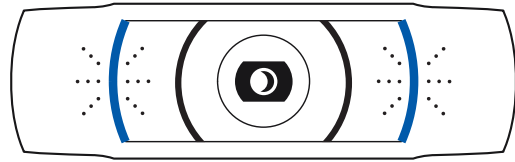

DIMENSÕES

INCLUINDO CLIPE DE MONTAGEM FIXO

Altura x largura x profundidade:

43.3 mm (1,70 pol.) x 94 mm (3,70 pol.) x 71 mm (2,80 pol.)

Comprimento do cabo: 1,5 m (5 pés)

Peso: 162 g (5,71 oz)

www.logitech.com/support/C920X

KEN UW PRODUCT

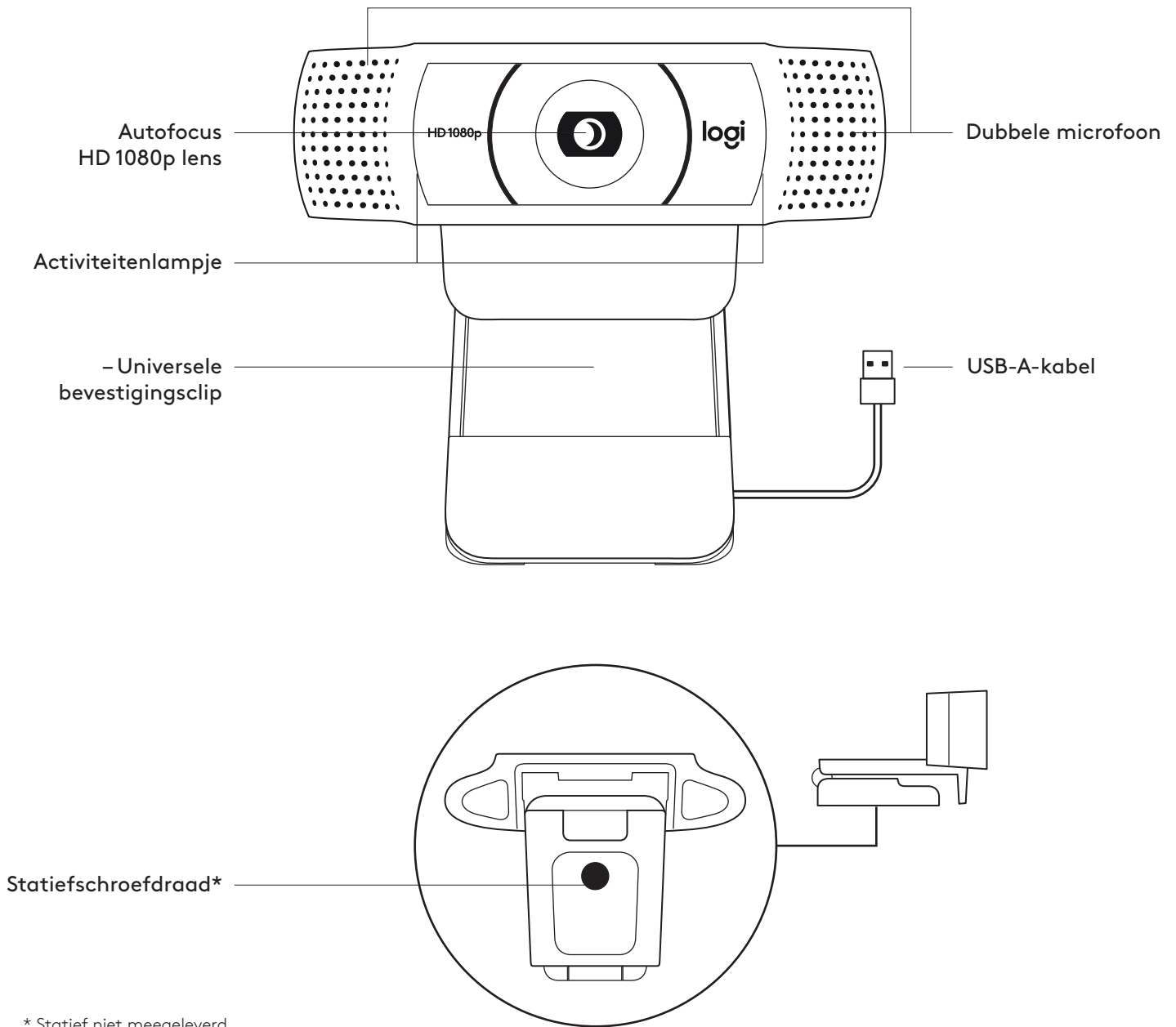

INHOUD VAN DE DOOS

- 1 5 webcam met aangesloten USB-A-kabel van 1,5 m (1.5 ft)
- 2 Coupon voor XSplit-licentie
- 3 Handleiding

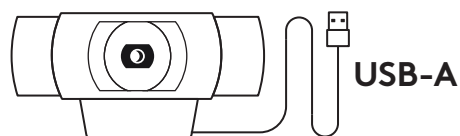

DE WEBCAM OPZETTEN

Voor bevestiging op een monitor

- 1 Plaats de webcam op een computer, laptop of beeldscherm in een positie of hoek naar keuze.



- 2 Pas de webcam aan, zodat het voetje op de universele bevestigingsclip in één lijn staat met de achterkant van het apparaat.



- 3 Zet de webcam handmatig omhoog of omlaag in de beste positie tot je goed in beeld bent.

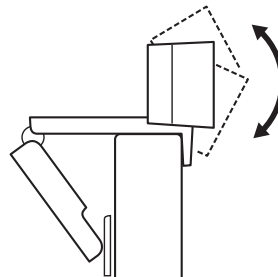

Voor bevestiging op een statief*

- 1 Zoek de schroefdraad van het statief ($\frac{1}{4}$ inch) aan de onderkant van de universele bevestigingsclip.

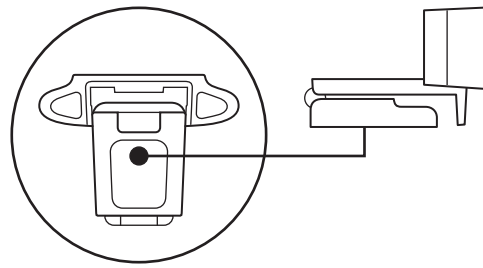

- 2 Zet de webcam op het statief vast door het op de draad ($\frac{1}{4}$ inch) te schroeven.

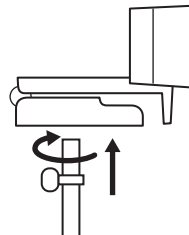

- 3 Plaats de webcam met het statief waar u maar wilt om uzelf zo goed mogelijk in beeld te brengen.

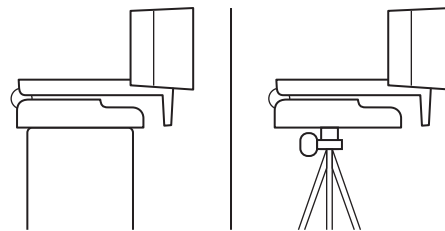

*Statief niet meegeleverd

DE WEBCAM VIA USB-A AANSLUITEN

Sluit de USB-connector op de USB-A-poort van je computer aan.

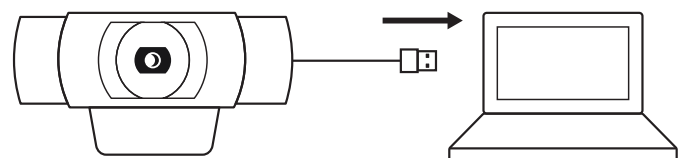

GESLAAGDE VERBINDING

Het led-activiteitslampje brandt wanneer de webcam door een toepassing wordt gebruikt.

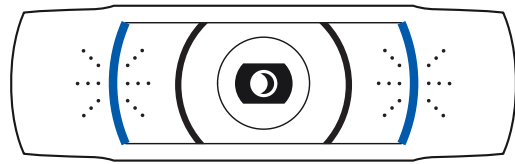

AFMETINGEN

MET VASTE BEVESTIGINGSCLIP:

Hoogte x breedte x diepte:

43,3 mm (1,70 in) x 94 mm (3,70 in) x 71 mm (2,80 in)

Kabellengte: 1,5 m (5 ft)

Gewicht: 162 g (5,71 oz)

www.logitech.com/support/C920X

PRODUKTÖVERSIKT

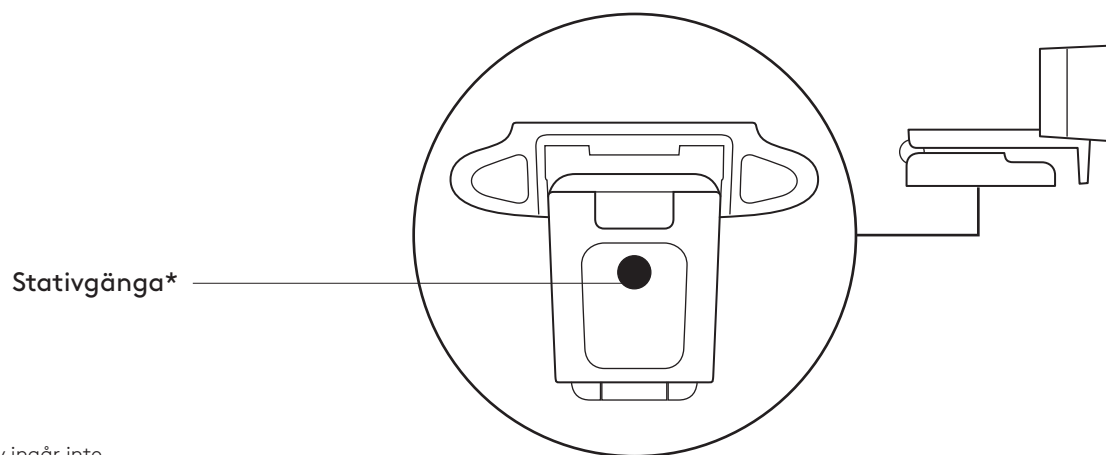
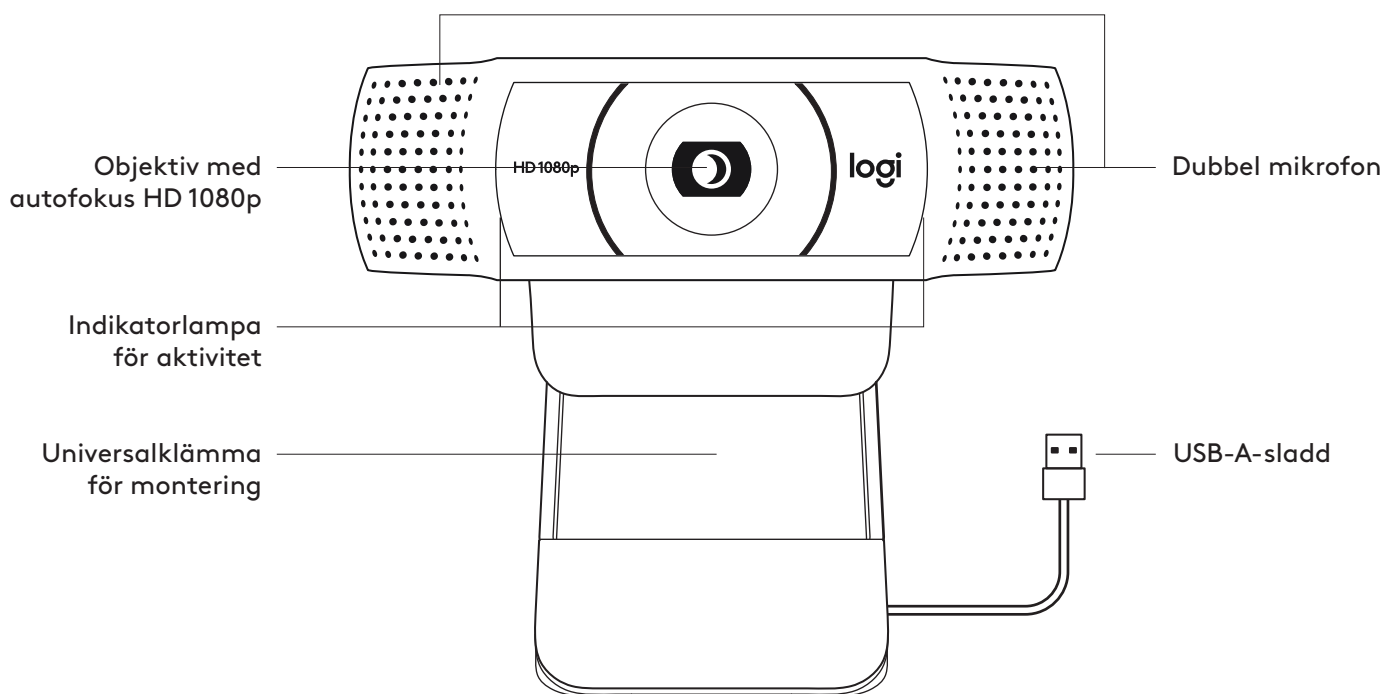

* Stativ ingår inte

INNEHÅLL

- 1 Webbkamera med 1,5 m (1,5 fot) USB-A-sladd
- 2 XSplit-licenskupong
- 3 Bruksanvisning

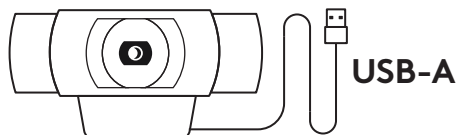

STÄLLA IN WEBBKAMERA

Placera på en skärm

- 1 Placera webbkameran på en stationär eller bärbar dator eller skärm i önskad position eller vinkel.



- 2 Justera webbkameran för att se till att foten på den universella monteringsklämman sitter ordentligt baktill på enheten.

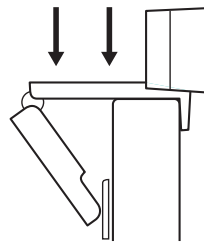

- 3 Justera manuellt webbkameran upp/ner så att den ramar in dig på bästa möjliga sätt.

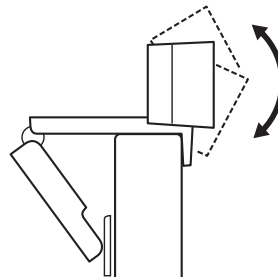

Placera på ett stativ*

- 1 Lokalisera stativgöngen på $\frac{1}{4}$ tum längst ner på den universella monteringsklämman.

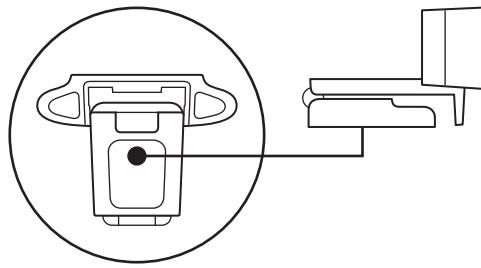

- 2 Säkra webbkameran på stativet genom att vrida in kameran i $\frac{1}{4}$ tumsspåret.

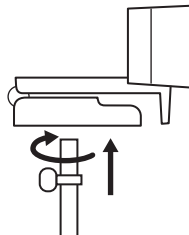

- 3 Placera webbkameran med stativet var du vill för att den ska rama in dig på bästa sätt.

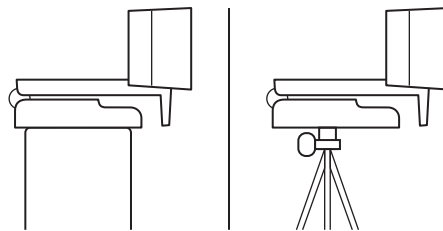

* Stativ ingår inte

ANSLUTA WEBBKAMERAN VIA USB-A-SLADD

Anslut USB-kontakten till USB-A-porten på datorn.

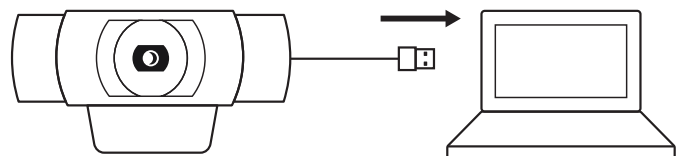

ANSLUTEN

Indikatorlampan för aktivitet tänds när webbkamera används av ett program.

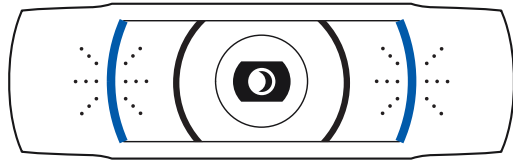

MÅTT

INKLUSIVE FIXERAD MONTERINGSKLÄMMA:

Höjd x bredd x djup:
43,3 mm (1,70 tum) x 94 mm (3,70 tum) x 71 mm (2,80 tum)

Sladdlängd: 1,5 m (5 fot)

Vikt: 162 g (5,71 uns)

www.logitech.com/support/C920X

PRODUKTOVERSIGT

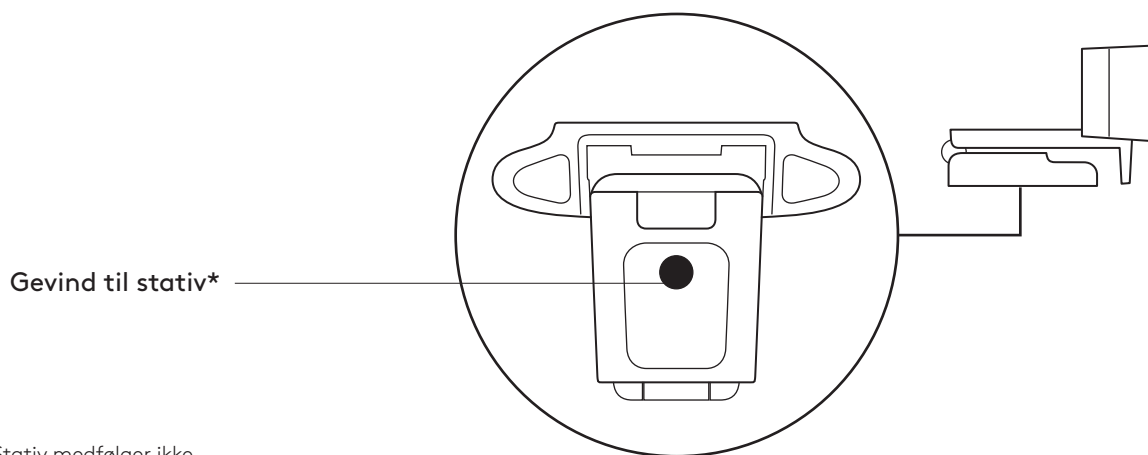
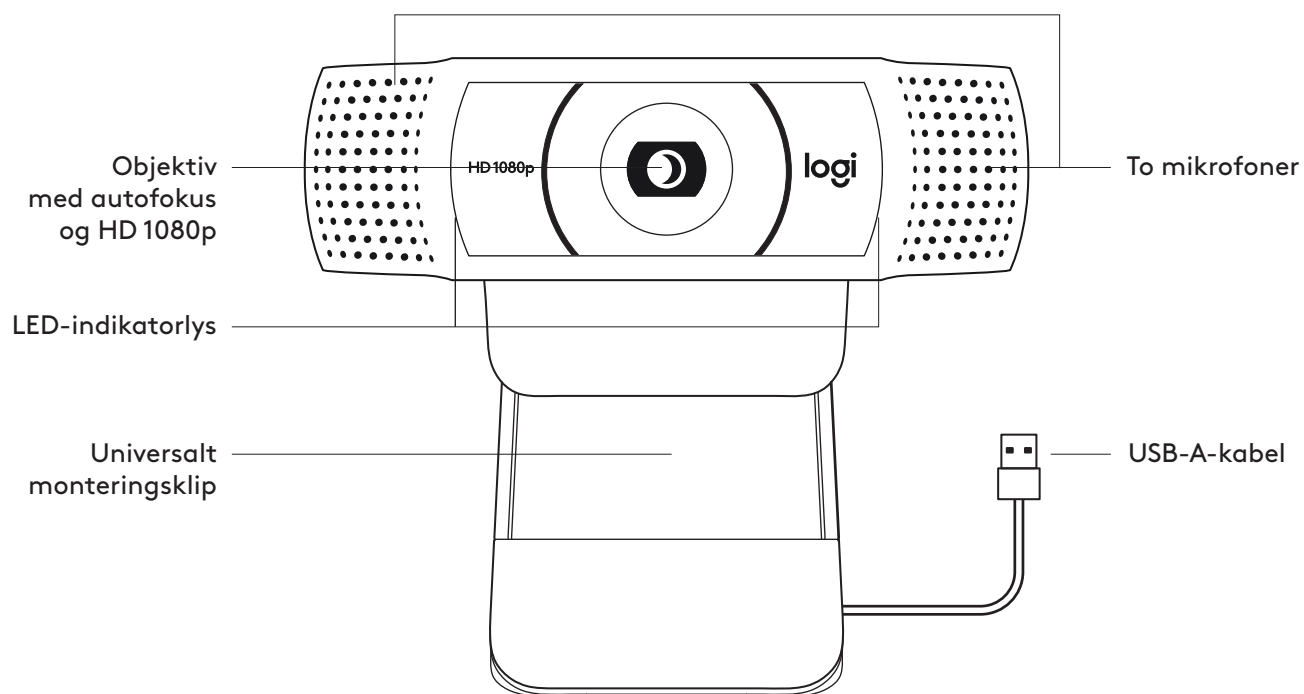

* Stativ medfølger ikke

DET INDEHOLDER KASSEN

- 1 Webkamera med 1,5 m (1.5 ft) medfølgende USB-A-kabel
- 2 XSplit-licenskupon
- 3 Brugervejledning

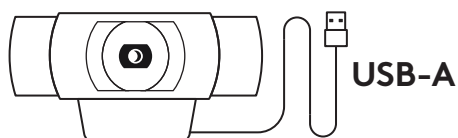

OPSÆTNING AF WEBKAMERAET

Ved montering på en skærm

- 1 Placer webkameraet på en computer, en bærbar eller en skærm på en måde og i en vinkel, som passer.



- 2 Juster webkameraet så foden på den universale monteringsclips flugter med bagsiden af din enhed.



- 3 Juster webkameraet manuelt op/ned til den position, hvor du ses bedst.

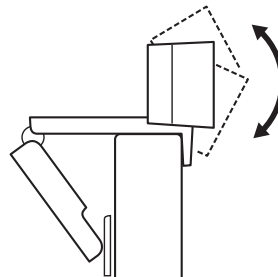

Ved montering på et stativ*

- 1 Find stativgevindet i bunden af webkameraets universelle monteringsclips.

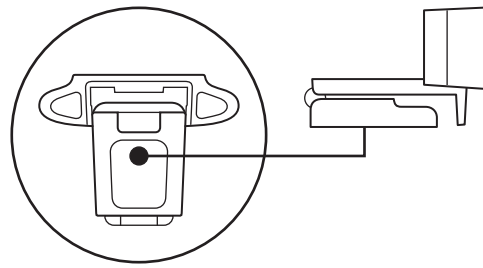

- 2 Sæt webkameraet fast på stativet ved at dreje stativet ind i gevindet.

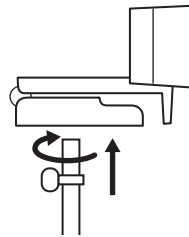

- 3 Placer webkameraet med stativet hvor som helst for at få dig selv i den bedste position i billedet.

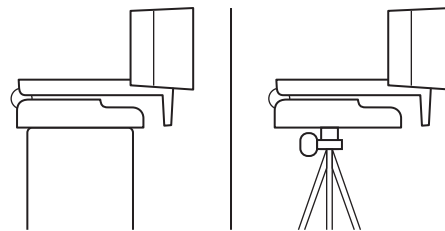

* Stativ medfølger ikke

TILSLUTNING AF WEBKAMERAET VIA USB-A

Sæt USB-A-stikket i USB-A-porten på computeren.

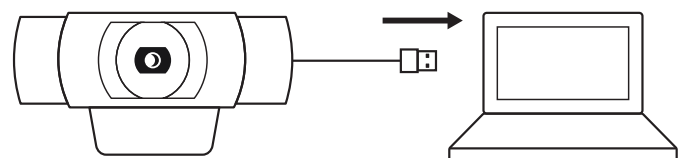

TILSLUTNING

LED-aktivitetslys lyser op når webkameraet er i brug af et program.

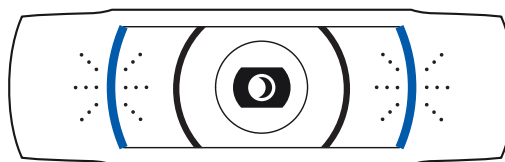

MÅL

INKLUSIVE FAST MONTERINGSCLIPS:

Højde x bredde x dybde:

43,3 mm (1,70") x 94 mm (3,70") x 71 mm (2,80")

Kabellængde: 1,5 m (5 ft)

Vægt: 162 g (5,71 oz)

www.logitech.com/support/C920X

BLI KJENT MED PRODUKTET

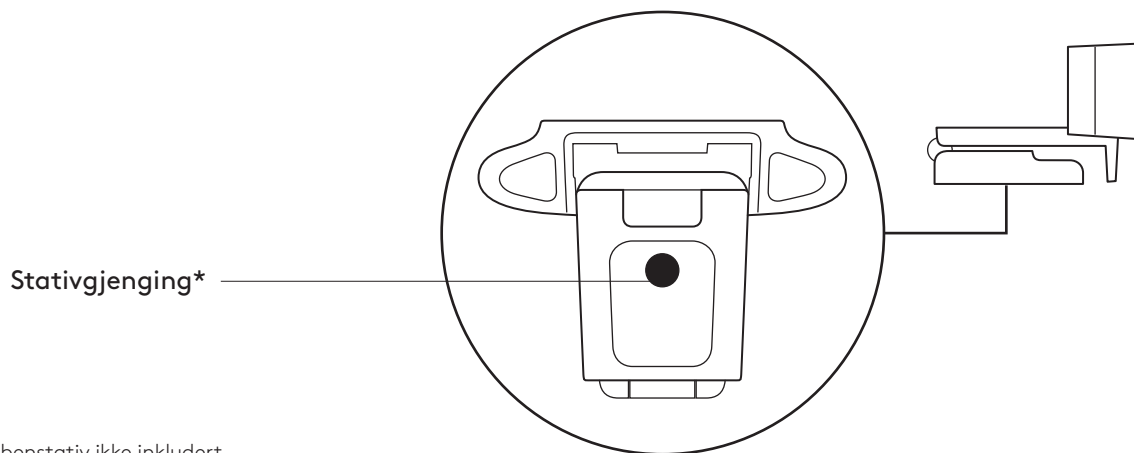
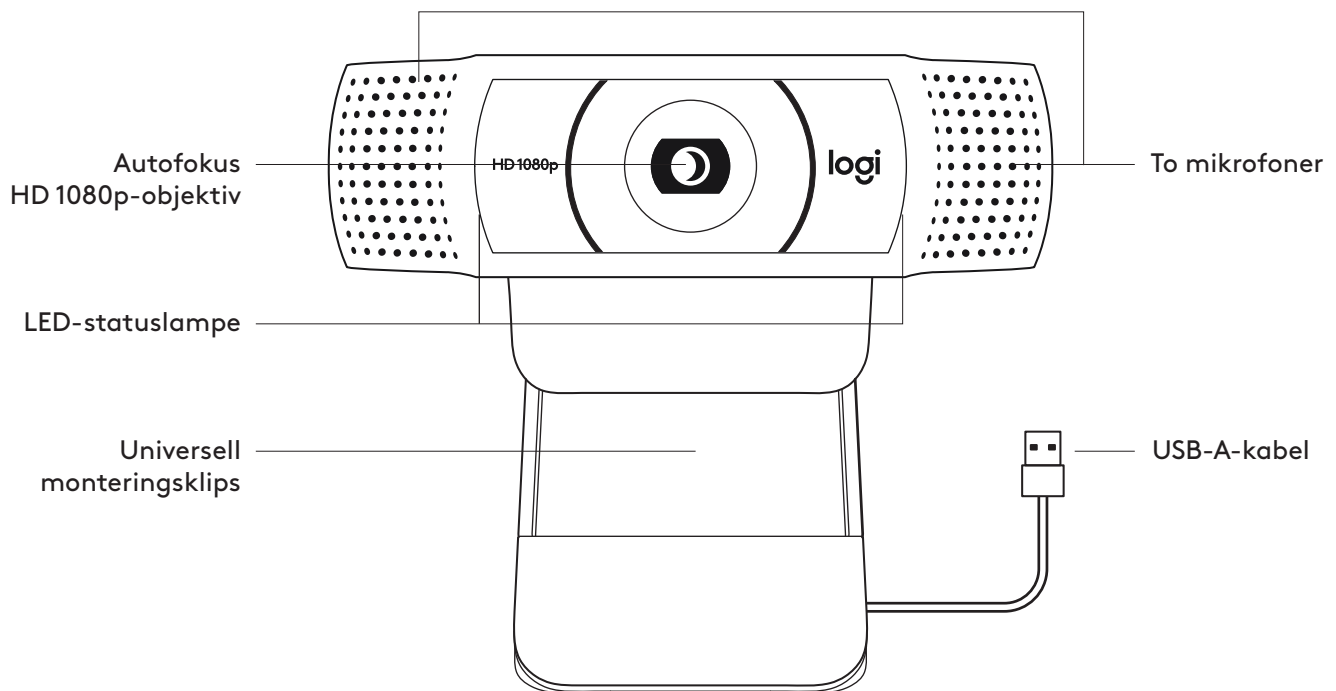

*Trebenstativ ikke inkludert

I ESKEN

- 1 Webkamera med vedlagt USB-A-kabel på 1,5 m
- 2 XSplit lisenskupong
- 3 Brukerdokumentasjon

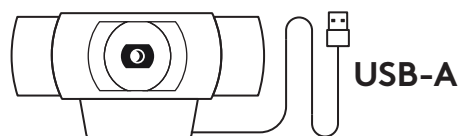

SETTE OPP WEBKAMERAET

På datamaskinskjermen

- 1 Sett webkameraet i ønsket vinkel på en datamaskin eller en bærbar datamaskin.



- 2 Juster webkameraet for å forsikre deg om at den universelle monteringsklipsen er i flukt med baksiden av enheten.

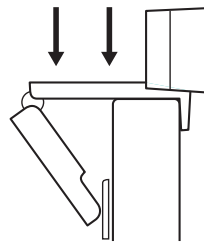

- 3 Juster webkameraet opp/ned for å finne den beste posisjonen for å filme deg selv.

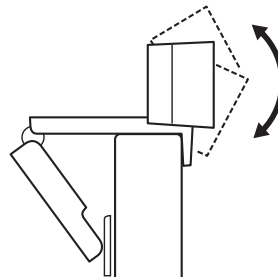

På et trebenstativ*

- 1 Finn gjengingen for trebenstativet (¼-tommers) nederst på den universelle monteringsklipsen.

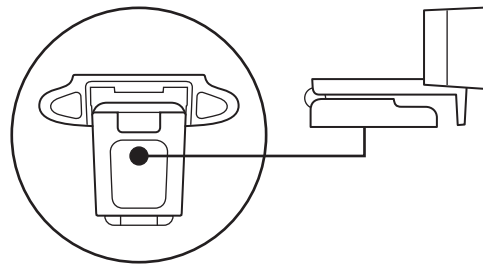

- 2 Fest webkameraet på stativet ved å skru det inn i den ¼-tommers gjengingen.

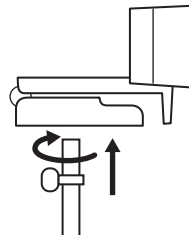

- 3 Plasser webkameraet med trebenstativet hvor du vil, slik at du får et best mulig bilde av deg selv.

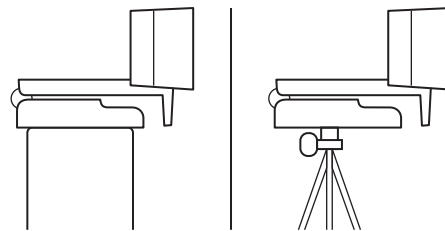

*Trebenstativ ikke inkludert

KOBLE TIL WEBKAMERAET VIA USB-A

Koble USB-A-kontakten til en annen USB-A-port på datamaskinen.

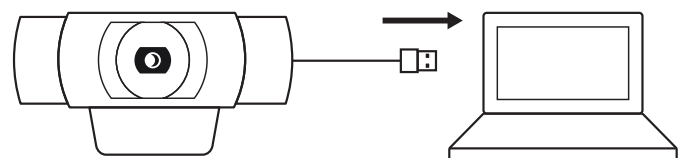

TILKOBLING FULLFØRT

LED-statuslampen lyser når webkameraet er i bruk av et program.

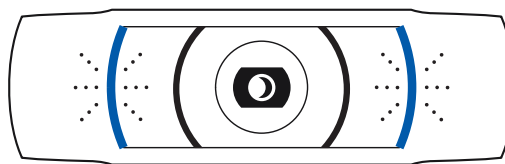

MÅL

INKLUDERT FASTE MONTERINGSKLIPS:

Høyde x bredde x dybde:
43,3 x 94 x 71 cm

Kabellengde: 1,5 m

Vekt: 162 g

www.logitech.com/support/C920X

TUNNE TUOTTEESI

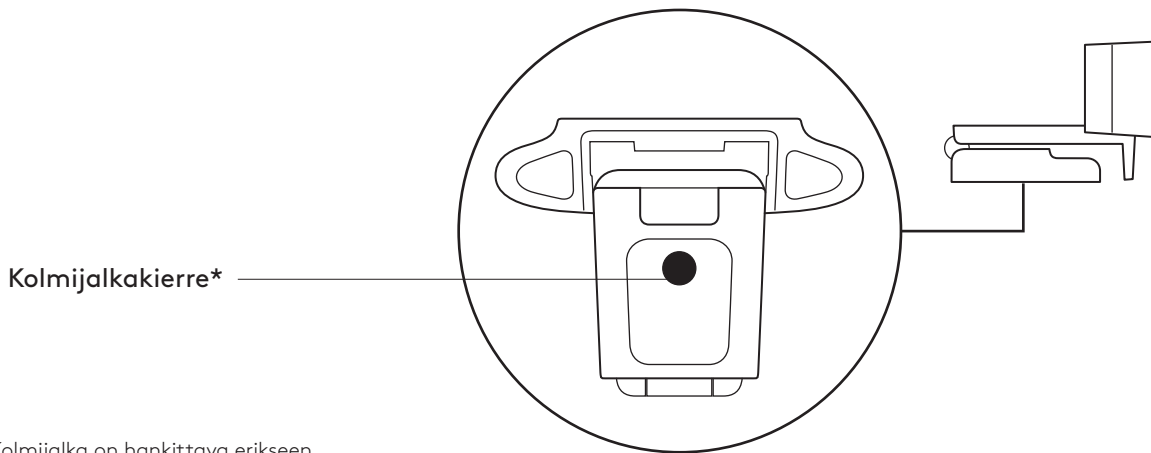
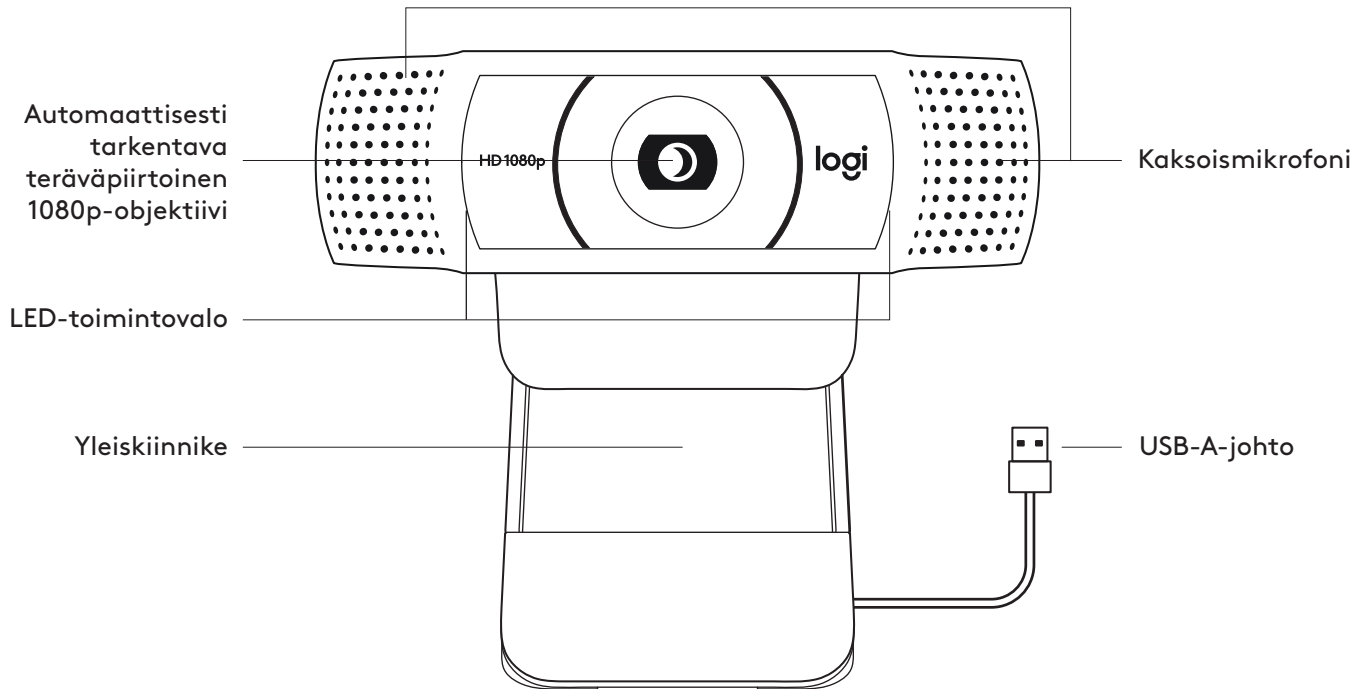

*Kolmijalka on hankittava erikseen.

PAKKAUKSEN SISÄLTÖ

- 1 Verkkokamera ja 1,5 metrin (5 jalan) kiinteä USB-A-johto
- 2 XSplit-käyttöoikeuskupongi
- 3 Käyttäjän dokumentaatio

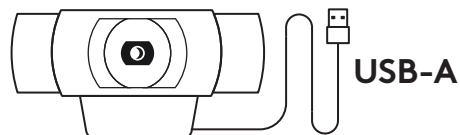

VERKKOKAMERAN KÄYTTÖNOTTO

Näytön päälle sijoittaminen

- 1 Aseta verkkokamera tietokoneen, kannettavan tai näytön päälle valitsemaasi asentoon tai kulmaan.



- 2 Säädä verkkokameraa niin, että yleiskiinnikkeen kanta on tukevasti kiinni laitteen takaosassa.



- 3 Käännä verkkokameraa manuaalisesti ylös tai alas niin, että saat sovitettua itsesi hyvin kuvaan.

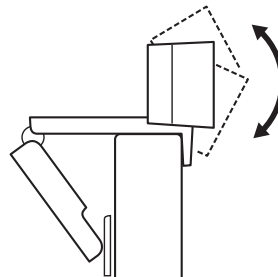

Kolmijalan päälle sijoittaminen*

- 1 Etsi yleiskiinnikkeen pohjasta neljännestuuman kolmijalkakierre.

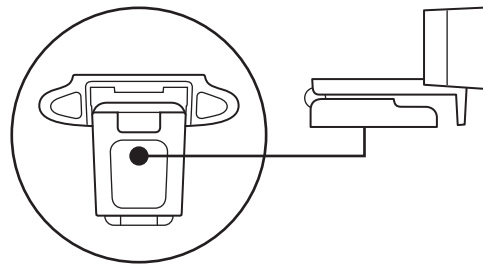

- 2 Kiinnitä verkkokamera kolmijalkaan kiertämällä se neljännestuuman kierteeseen.

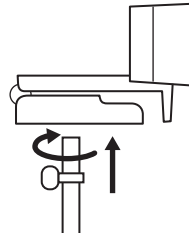

- 3 Sijoita kolmijalkaan kiinnitetty verkkokamera mihin haluat parhaan mahdollisen rajauksen saavuttamiseksi.

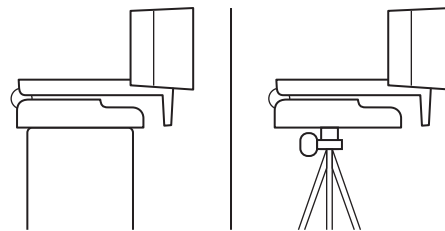

*Kolmijalka on hankittava erikseen.

VERKKOKAMERAN LIITTÄMINEN USB-A-JOHDOLLA

Liitä USB-A-liitin tietokoneen USB-A-porttiin.

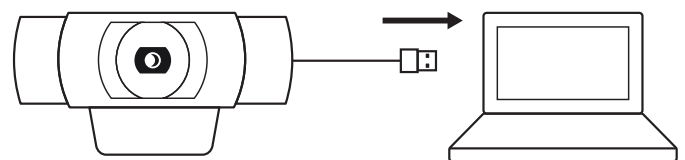

YHTEYS MUODOSTETTU

LED-toimintovalo syttyy, kun jokin sovellus käyttää verkkokameraa.

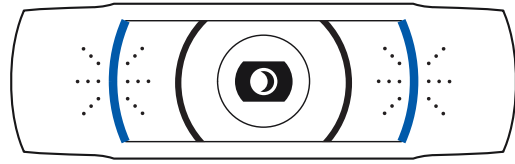

MITAT

MUKAAN LUKIEN PAIKOILLAAN OLEVA KIIINNIKE:

Korkeus x leveys x syvyys:

43,3 x 94 x 71 mm (1,70 x 3,70 x 2,80 tuumaa)

Johdon pituus: 1,5 m (5 jalkaa)

Paino: 162 g (5,71 unssia)

www.logitech.com/support/C920X

ΓΝΩΡΙΜΙΑ ΜΕ ΤΟ ΠΡΟΪΟΝ

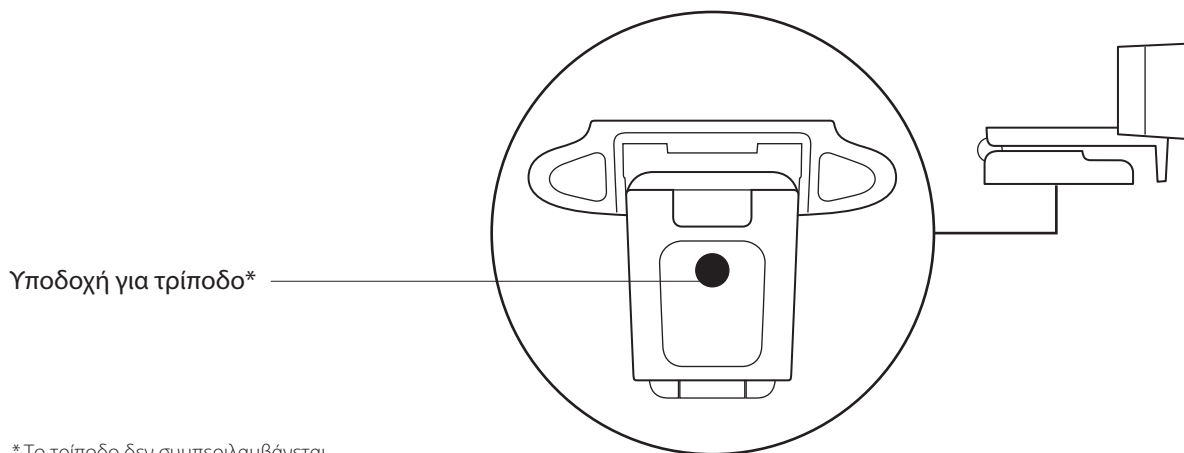
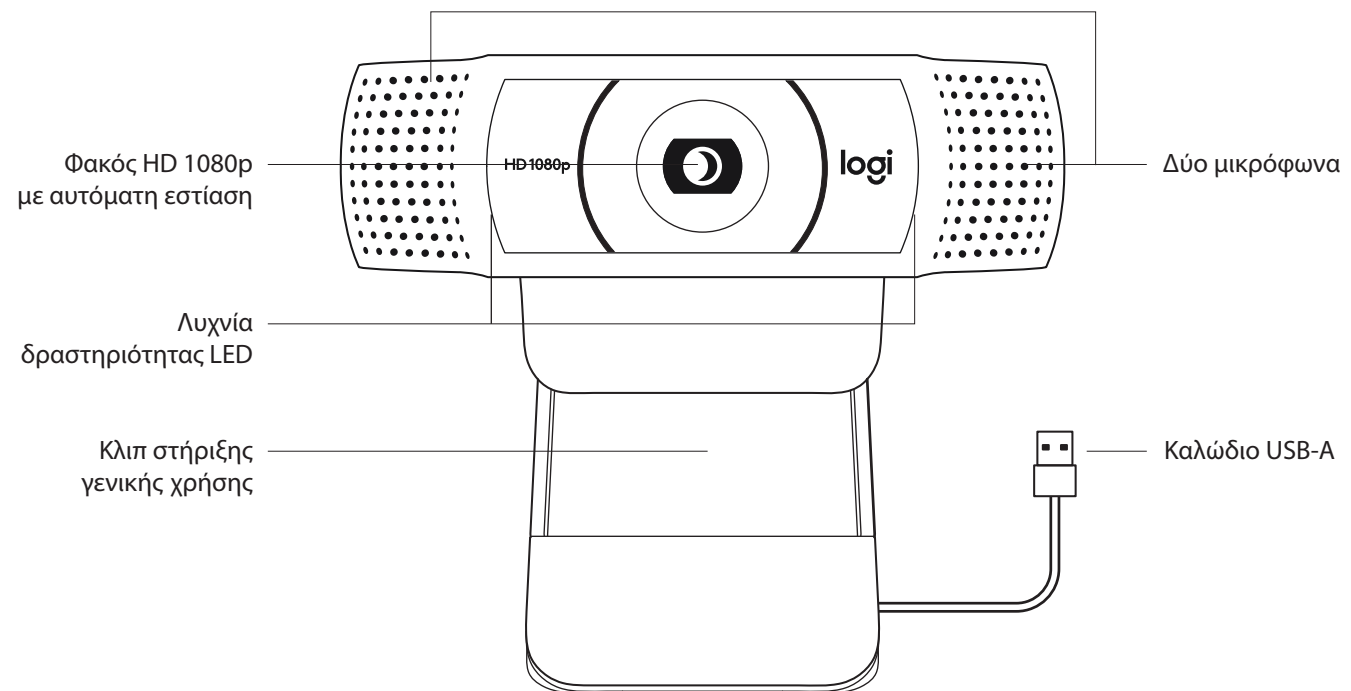

* Το τρίποδο δεν συμπεριλαμβάνεται

ΠΕΡΙΕΧΟΜΕΝΑ ΣΥΣΚΕΥΑΣΙΑΣ

- 1 Webcam με ενσωματωμένο καλώδιο USB-A 1,5 m (5 ft)
- 2 Κουπόνι άδειας χρήσης XSplit
- 3 Τεκμηρίωση χρήστη

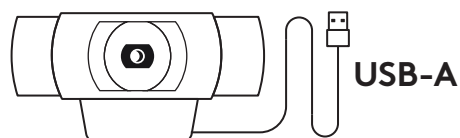

USB-A



ΡΥΘΜΙΣΗ ΤΗΣ WEBCAM

Για τοποθέτηση σε οθόνη

- 1 Τοποθετήστε την webcam σε έναν υπολογιστή, φορητό υπολογιστή ή οθόνη στη θέση ή τη γωνία που επιθυμείτε.

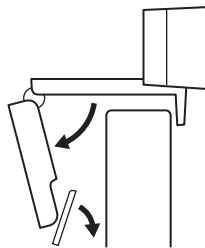

- 2 Ρυθμίστε την webcam για να βεβαιωθείτε ότι το πόδι του κλιπ στήριξης γενικής χρήσης είναι ευθυγραμμισμένο με το πίσω μέρος της συσκευής σας.

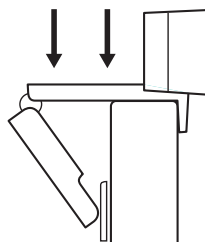

- 3 Ρυθμίστε με μη αυτόματο τρόπο την webcam επάνω/κάτω, στη θέση που προσφέρει το καλύτερο καδράρισμα.

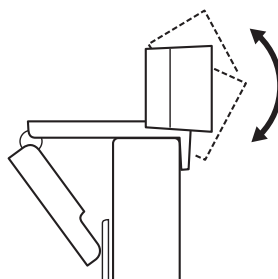

Για τοποθέτηση σε τρίποδο*

- 1 Εντοπίστε την υποδοχή για τρίποδο ¼ ιντσών στο κάτω μέρος του κλιπ στήριξης γενικής χρήσης.

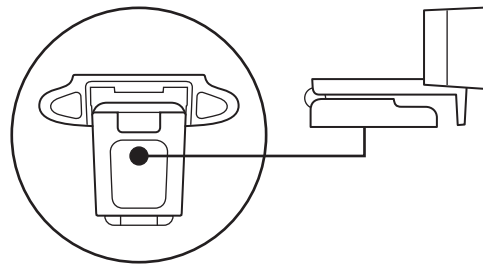

- 2 Ασφαλίστε την webcam στο τρίποδο στρέφοντας το τρίποδο μέσα στην υποδοχή ¼ ιντσών.

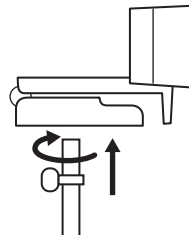

- 3 Τοποθετήστε την webcam με το τρίποδο όπου θέλετε, στη θέση που προσφέρει το καλύτερο καδράρισμα.

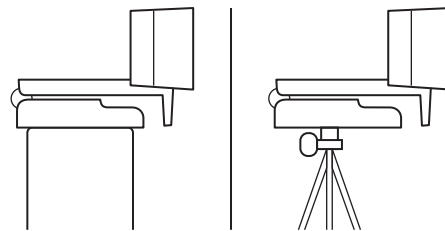

* Το τρίποδο δεν συμπεριλαμβάνεται

ΣΥΝΔΕΣΗ ΤΗΣ WEBCAM ΜΕΣΩ USB-A

Συνδέστε το βύσμα USB-A στη θύρα USB-A του υπολογιστή σας.

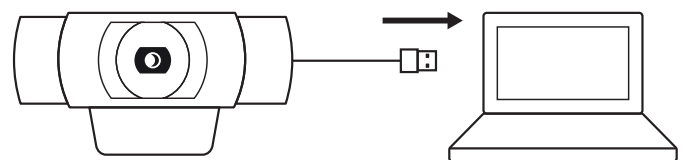

ΕΠΙΤΥΧΗΣ ΣΥΝΔΕΣΗ

Η λυχνία δραστηριότητας LED θα ανάβει όταν η webcam χρησιμοποιείται από κάποια εφαρμογή.

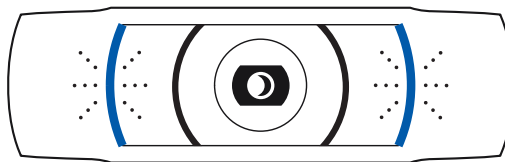

ΔΙΑΣΤΑΣΕΙΣ

ΜΕ ΤΟ ΣΤΑΘΕΡΟ ΚΛΙΠ ΣΤΗΡΙΞΗΣ:

Ύψος x Πλάτος x Βάθος:

43,3 mm (1,70 in) x 94 mm (3,70 in) x 71 mm (2,80 in)

Μήκος καλωδίου: 1,5 m (5 ft)

Βάρος: 162 g (5,71 oz)

www.logitech.com/support/C920X

ЗНАКОМСТВО С ПРОДУКТОМ

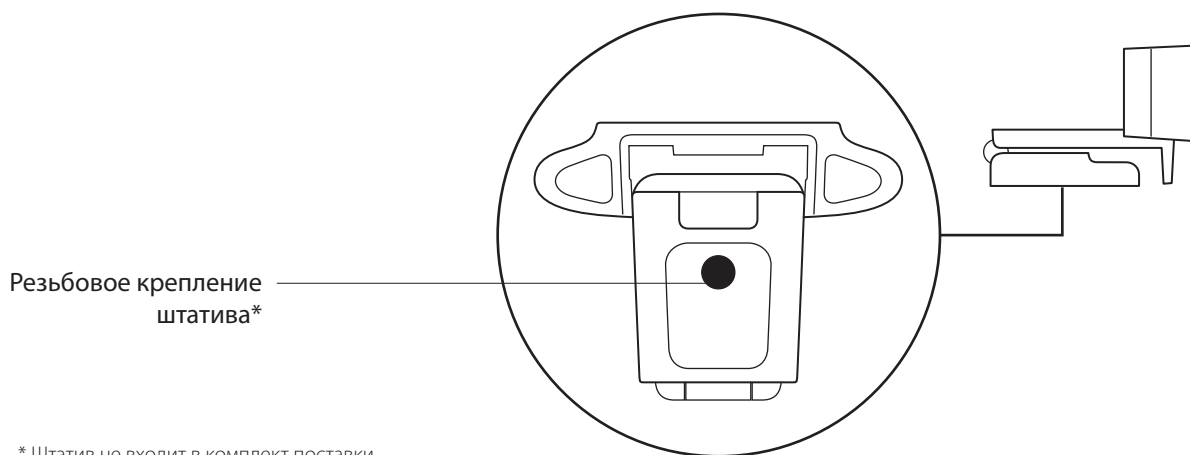
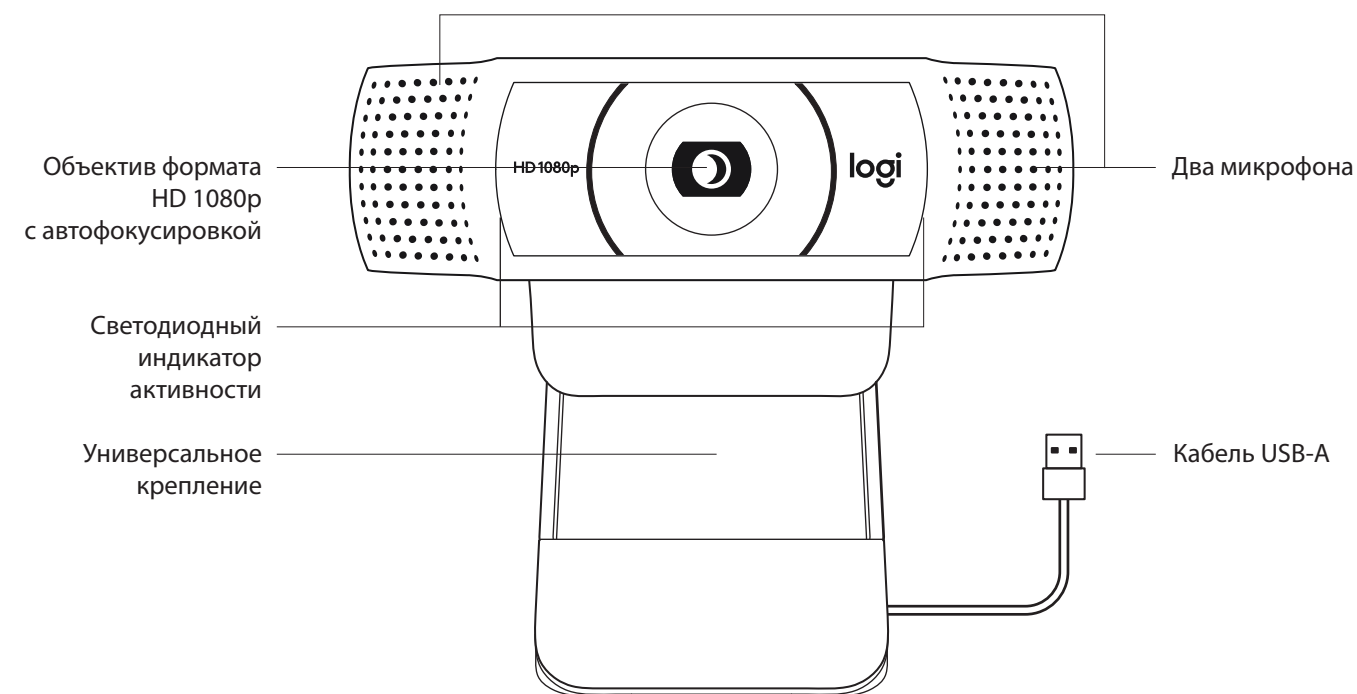

* Штатив не входит в комплект поставки.

КОМПЛЕКТ ПОСТАВКИ

- 1 Веб-камера с прикрепленным кабелем USB-A (1,5 м)
- 2 Купон лицензии XSplit
- 3 Документация пользователя

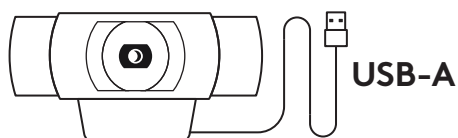

ПОДГОТОВКА ВЕБ-КАМЕРЫ К РАБОТЕ

Размещение на мониторе

- 1 Установите веб-камеру на компьютер, ноутбук или монитор в нужном положении и под нужным углом.

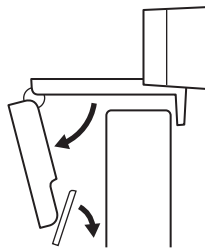

- 2 Отрегулируйте положение веб-камеры так, чтобы нижняя поверхность универсального крепления прилегала к задней панели устройства.

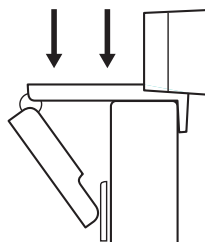

- 3 Вручную отрегулируйте угол наклона веб-камеры, чтобы обеспечить оптимальное кадрирование.

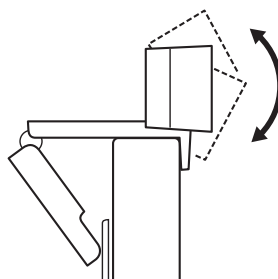

Размещение на штативе*

- 1 Установите резьбовое крепление штатива $\frac{1}{4}$ дюйма в нижней части универсального крепления.

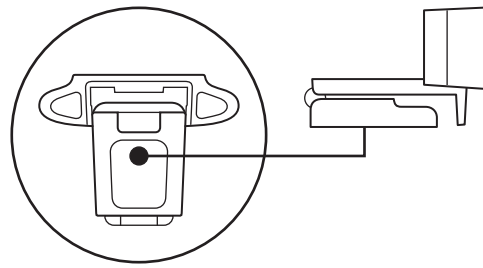

- 2 Закрепите веб-камеру на штативе с помощью резьбового крепления $\frac{1}{4}$ дюйма.

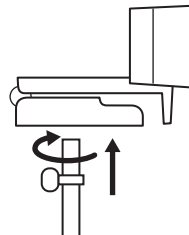

- 3 Разместите веб-камеру на штативе в любом месте, чтобы вам было удобно.

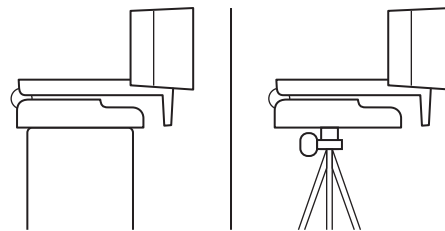

* Штатив не входит в комплект поставки.

ПОДКЛЮЧЕНИЕ ВЕБ-КАМЕРЫ ЧЕРЕЗ РАЗЪЕМ USB-A

Вставьте разъем USB-A в соответствующий порт компьютера.

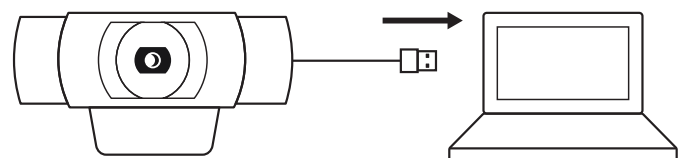

УСПЕШНОЕ ПОДКЛЮЧЕНИЕ

Светодиодный индикатор активности загорится, когда приложение начнет использовать веб-камеру.

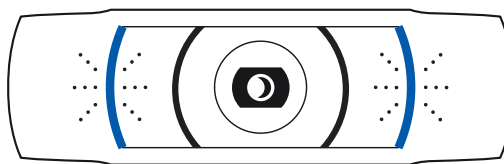

РАЗМЕРЫ

СО СТАЦИОНАРНЫМ КРЕПЛЕНИЕМ

Высота x ширина x длина:

43,3 мм x 94 мм x 71 мм

Длина кабеля: 1,5 м

Вес: 162 г

www.logitech.com/support/C920X

OPIS URZĄDZENIA

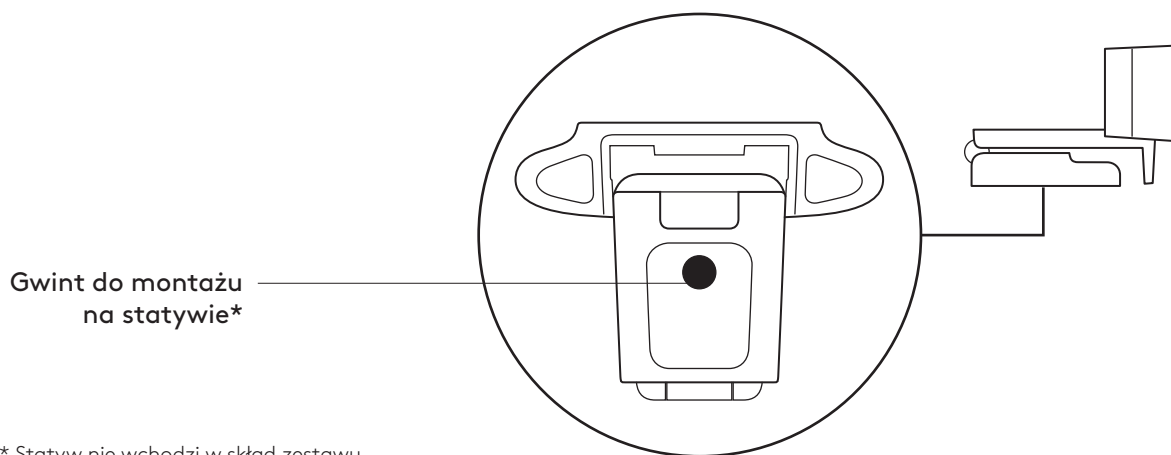
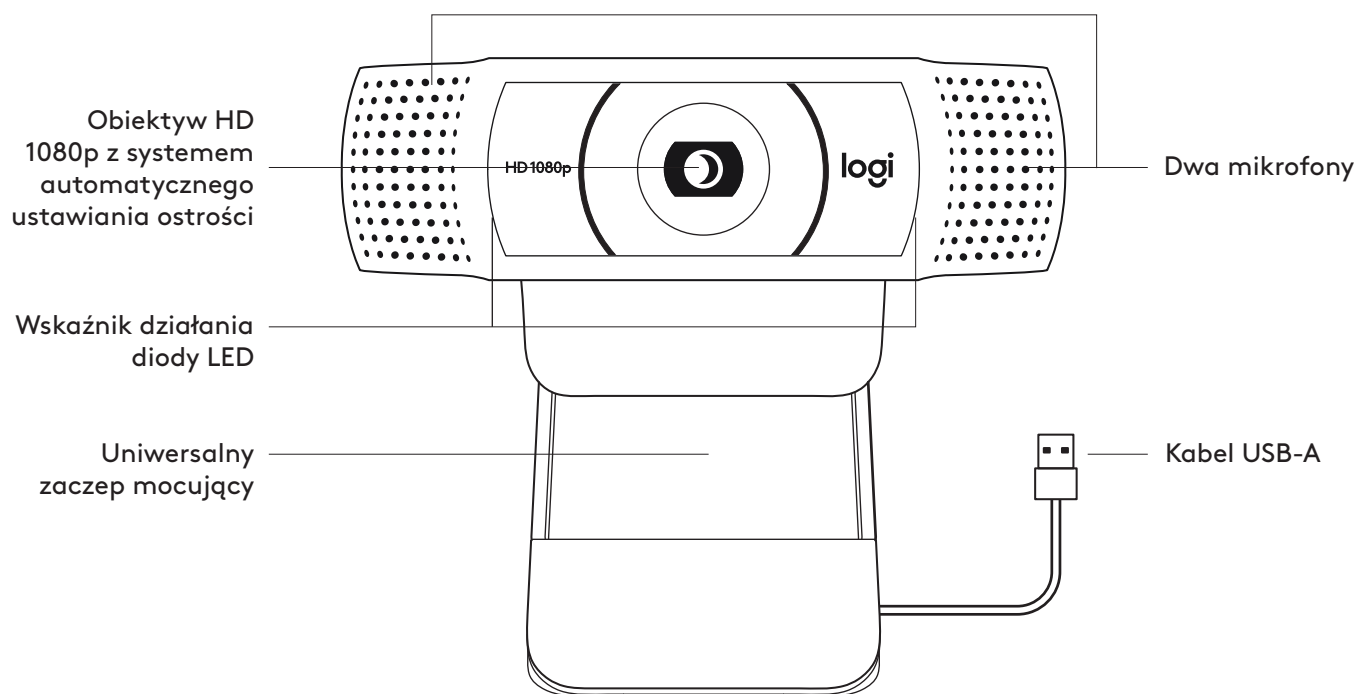

* Statyw nie wchodzi w skład zestawu

ZAWARTOŚĆ ZESTAWU

- 1 Kamera internetowa z dołączonym kablem USB-A o długości 1,5 m (5 stóp)
- 2 Kupon na licencję Xsplit
- 3 Dokumentacja produktu

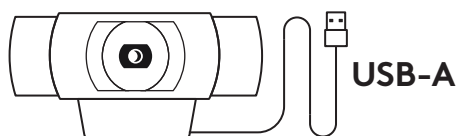

PRZYGOTOWYWANIE KAMERY INTERNETOWEJ

W celu umieszczenia na monitorze

- 1 Umieść kamerę internetową na komputerze, laptopie lub monitorze pod kątem, który Ci odpowiada.



- 2 Dostosuj kamerę internetową, aby upewnić się, że stopa na uniwersalnym zaczepie mocującym znajdowała się na równi z tylną częścią urządzenia.

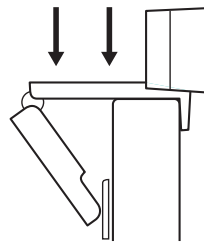

- 3 Ręcznie wyreguluj kamerę internetową w górę/w dół w celu uzyskania jak najlepszej pozycji do wykadrowania siebie.

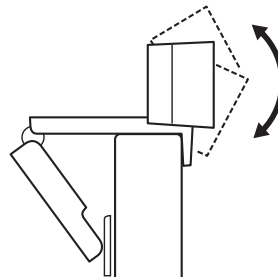

W celu umieszczenia na statywie*

- 1 Zlokalizować gwint do montażu na statywie ¼" na dole uniwersalnego zaczepu mocującego.

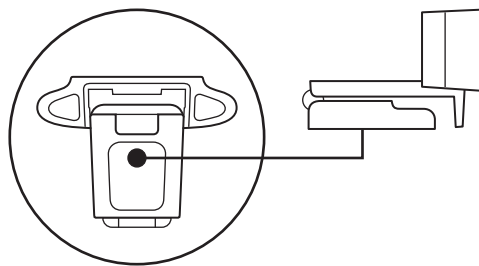

- 2 Zamocować kamerę internetową na statywie poprzez wkręcenie jej w gwint ¼ cala.

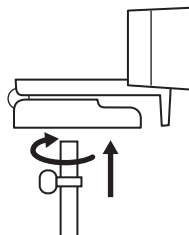

- 3 Umieść kamerę internetową ze statywem gdziekolwiek zechcesz, aby uzyskać najlepszą pozycję do kadrowania.

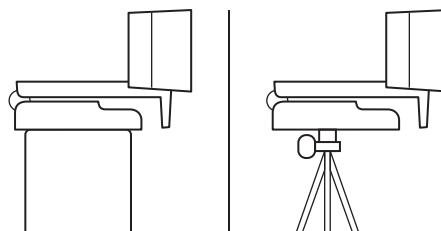

* Statyw nie wchodzi w skład zestawu

ŁĄCZENIE SIĘ Z KAMERĄ INTERNETOWĄ POPRAZ KABEL USB-A

Podłącz złącze USB do portu USB-A komputera.

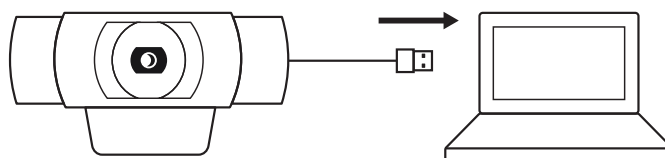

POMYŚLNIE POŁĄCZENIE

Wskaźnik działania diody LED zaświeci się, gdy kamera będzie używana przez aplikację.

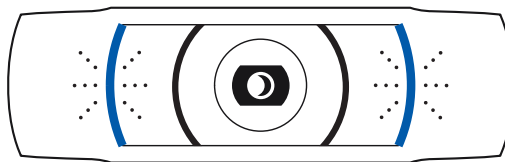

WYMIARY

RAZEM ZE STAŁYM ZACZEPEM MOCUJĄCYM:

Wysokość × szerokość × głębokość:

43,3 mm (1,70 cala) × 94 mm (3,70 cali) × 71 mm (2,80 cala)

Długość kabla: 1,5 m (5 stóp)

Masa: 162 g (5,71 uncji)

www.logitech.com/support/C920X

A TERMÉK ISMERTETÉSE

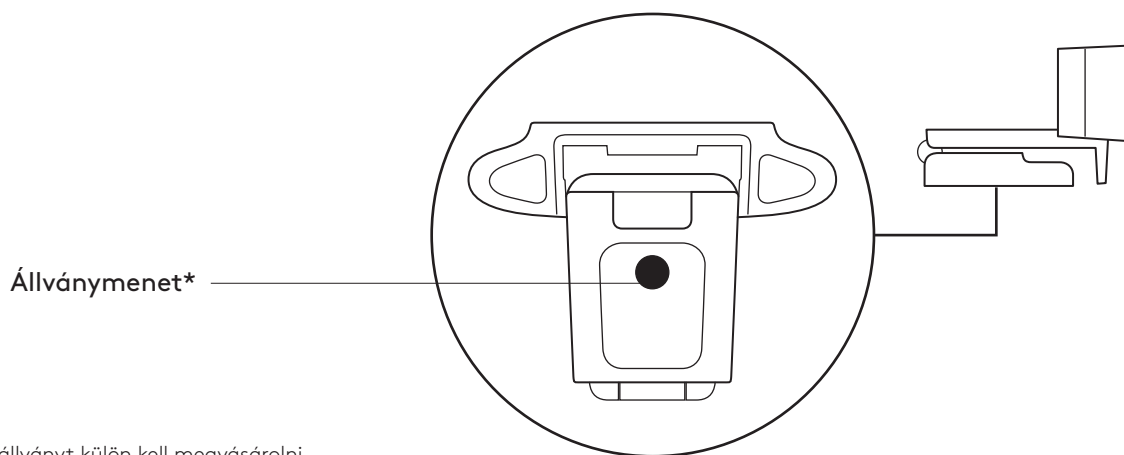
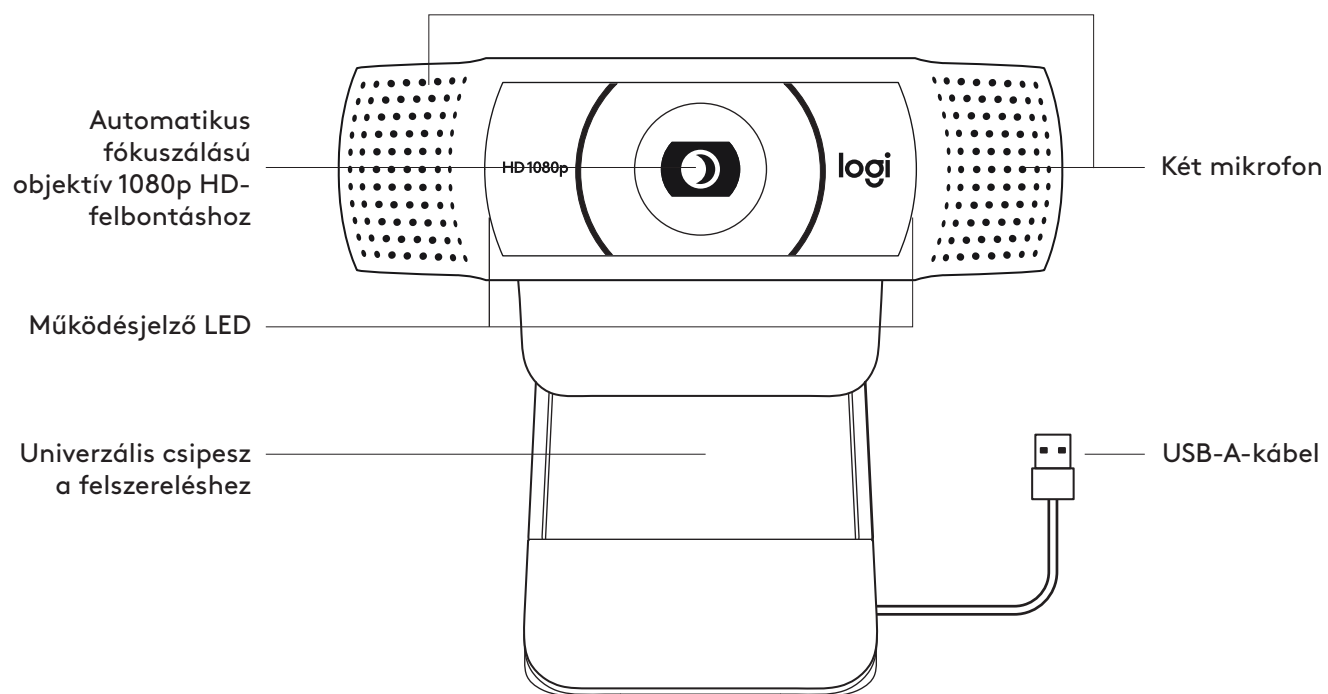

* Az állványt külön kell megvásárolni (The stand must be purchased separately)

A CSOMAG TARTALMA

- 1 webkamera 1,5 m-es (1,5 láb) rászereelt USB-A-kábellel (1 webcam with 1.5m (1.5ft) USB-A cable attached)
- 2 XSplit-licenckupon (2 XSplit license coupon)
- 3 Felhasználói útmutató (3 User manual)

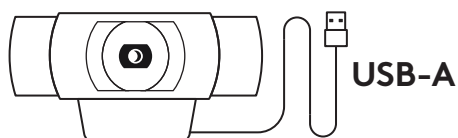

A WEBKAMERA ÜZEMBE HELYEZÉSE

Monitoron való elhelyezéshez

- 1 A webkamerát a számítógépén, laptopján vagy monitorán a kívánt szögben helyezheti el.

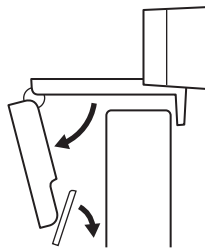

- 2 A webkamera beállításánál ügyeljen arra, hogy az univerzális csíptető talpa pontosan ráfeküdjön az eszközre.

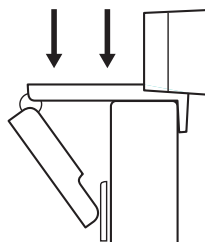

- 3 A webkamera le/fel irányú mozgásával állítsa be saját legjobb képkivágását.

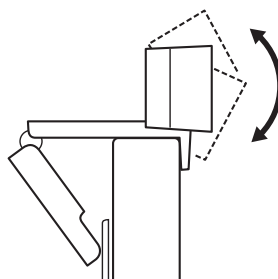

Állványon való elhelyezéshez*

- 1 Keresse meg az $\frac{1}{4}$ hüvelykes állványmenetet az univerzális szerelőcsíptető alján.

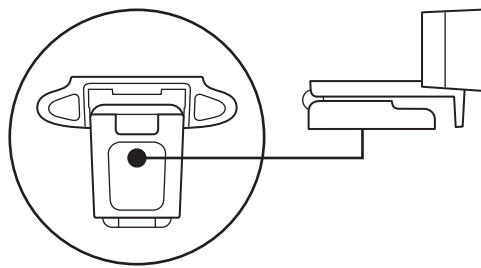

- 2 Rögzítse a webkamerát az állványon az $\frac{1}{4}$ hüvelykes menetbe forgatásával.

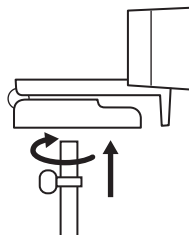

- 3 Az állványra helyezett kamerát helyezze el a legjobb képkivágást biztosító helyre.

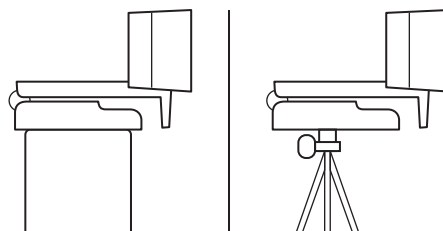

* Az állványt külön kell megvásárolni

A WEBKAMERA CSATLAKOZTATÁSA USB-A-N KERESZTÜL

Dugja az USB-A-csatlakozót a számítógép USB-A-portjába.

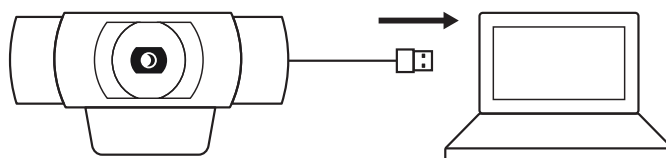

SIKERES CSATLAKOZÁS

A működésjelző LED fénye mutatja, hogy a webkamerát egy alkalmazás használja.

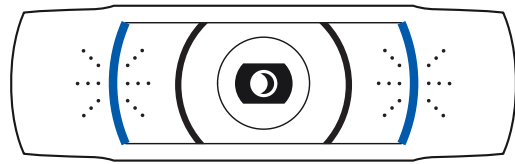

MÉRETEK

A RÖGZÍTŐCSIPESSZEL EGYÜTT:

Magasság × szélesség × mélység:

43,3 mm (1,70 hüvelyk) × 94 mm (3,70 hüvelyk) × 71 mm (2,80 hüvelyk)

Kábelhossz: 1,5 m (5 láb)

Tömeg: 162 g (5,71 uncia)

www.logitech.com/support/C920X

POPIS PRODUKTU

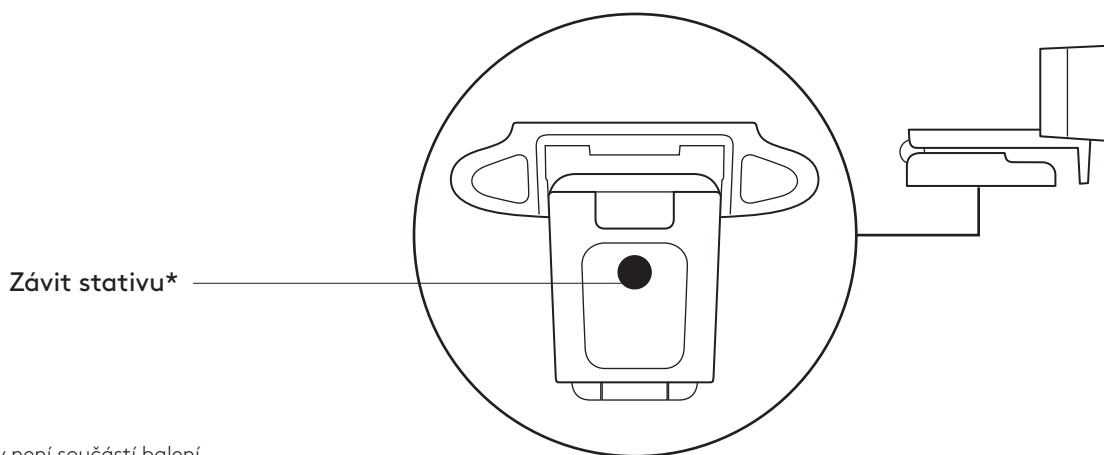
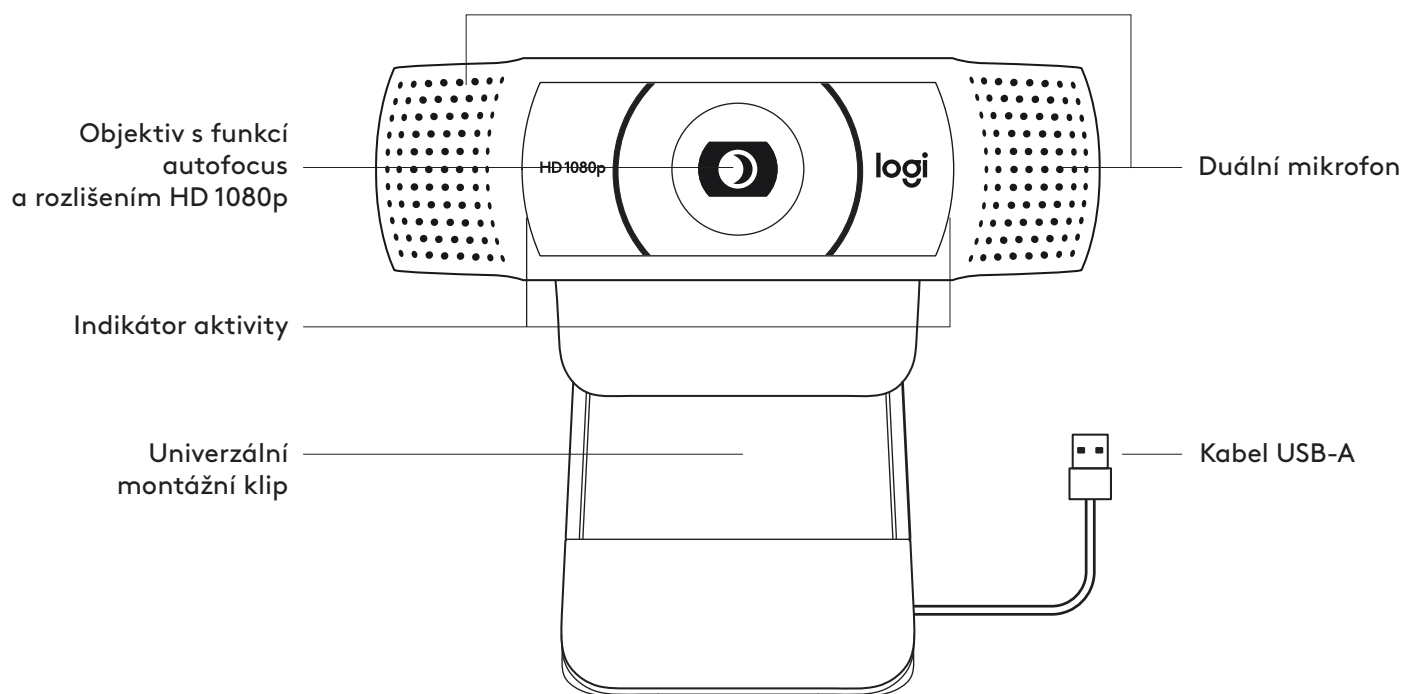

* Stativ není součástí balení

OBSAH BALENÍ

- 1 Webová kamera s připojeným kabelem USB-A o délce 1,5 m (1.5 ft)
- 2 Kupon licence XSplit
- 3 Uživatelská dokumentace

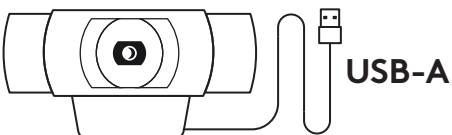

NASTAVENÍ WEBOVÉ KAMERY

Pokyny k umístění na monitor

- 1 Umístěte webovou kameru na počítač, notebook nebo monitor do požadované polohy nebo úhlu.

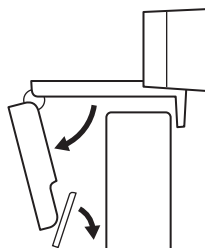

- 2 Po umístění webové kamery se ujistěte, že je spodek univerzálního montážního klipu vyrovnán se zadní částí vašeho zařízení.

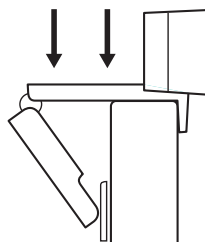

- 3 Ručně nastavte webovou kameru nahoru/dolů tak, abyste co nejlépe zabírali sami sebe.

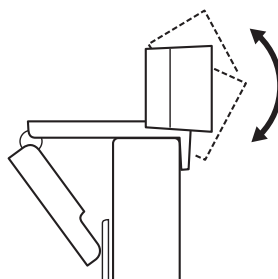

Pokyny k umístění na stativ*

- 1 Vyhledejte závit stativu 1/4 palce na spodku univerzálního upevňovacího klipu.

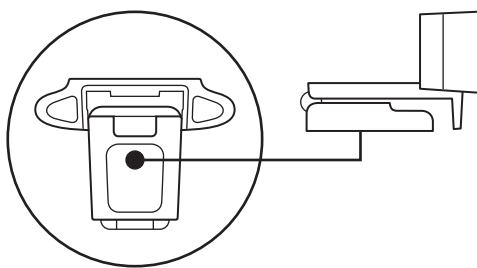

- 2 Upevněte webovou kameru na stativ našroubováním na závit 1/4 palce.

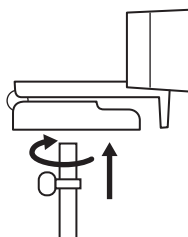

- 3 Umístěte webovou kameru se stativem na libovolné místo dle potřeby pro dosažení co nejlepšího záběru.

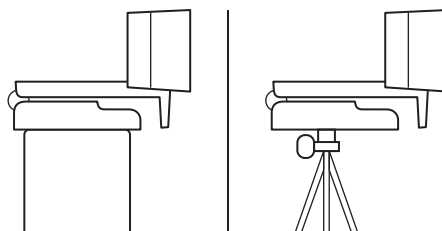

* Stativ není součástí balení

PŘIPOJENÍ WEBOVÉ KAMERY PROSTŘEDNICTVÍM USB-A

Zapojte konektor USB-A do portu USB-A v počítači.

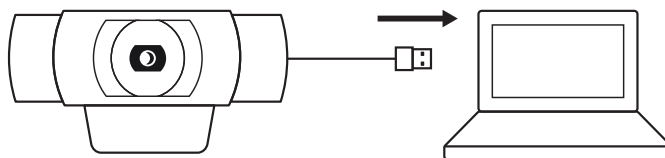

ÚSPĚŠNÉ PŘIPOJENÍ

Když je webová kamera používána aplikací, indikátor aktivity se rozsvítí.

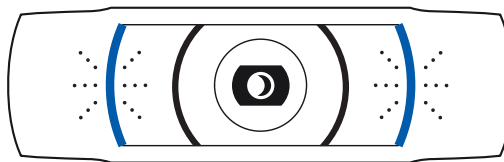

ROZMĚRY

VČETNĚ UPEVNĚNÉHO MONTÁŽNÍHO KLIPU:

Výška x šířka x hloubka:

43,3 mm (1,70 in) x 94 mm (3,70 in) x 71 mm (2,80 in)

Délka kabelu: 1,5 m (5 ft)

Hmotnost: 162 g (5,71 oz)

www.logitech.com/support/C920X

OPIS PRODUKTU

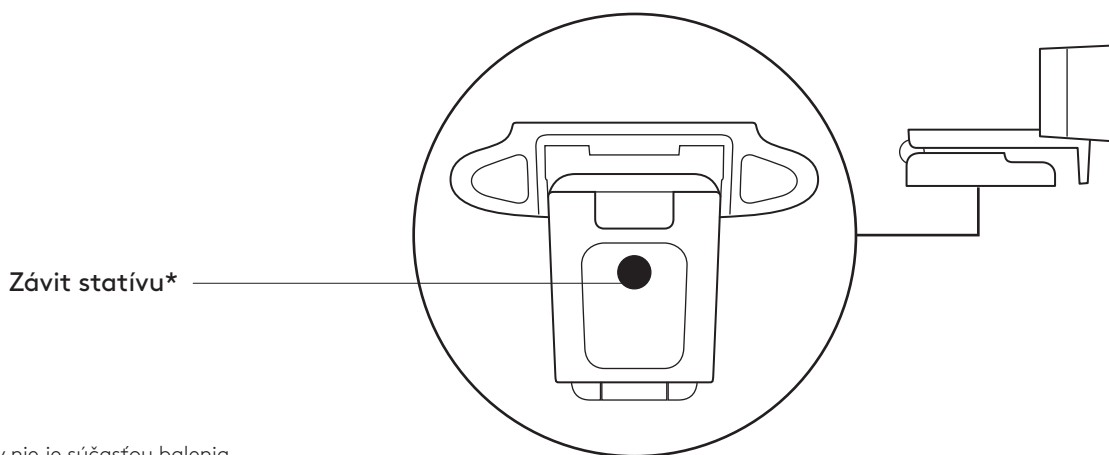
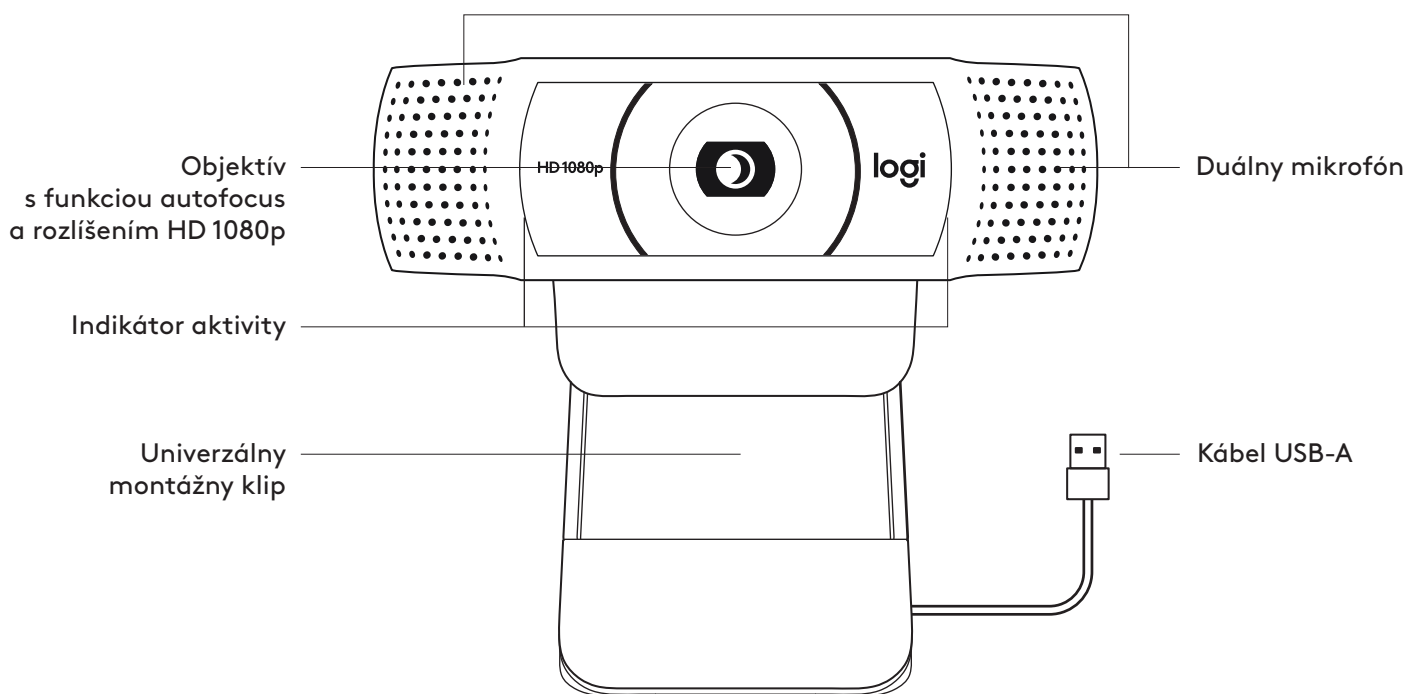

* Statív nie je súčasťou balenia

OBSAH BALENIA

- 1 Webová kamera s pripojeným káblom USB-A s dĺžkou 1,5 m (5 ft)
- 2 Kupón licencie Xsplit
- 3 Používateľská dokumentácia

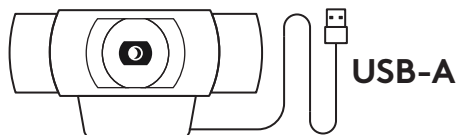

NASTAVENIE WEBOVEJ KAMERY

Pokyny pre umiestnenie na monitor

- 1 Umiestnite webovú kameru na počítač, notebook alebo monitor do požadovanej polohy alebo uhla.



- 2 Po umiestnení webovej kamery sa ubezpečte, že je spodok univerzálneho montážneho klipu vyrovnaný so zadnou časťou vášho zariadenia.



- 3 Ručne nastavte webovú kameru nahor/nadol tak, aby ste čo najlepšie zaberali seba.

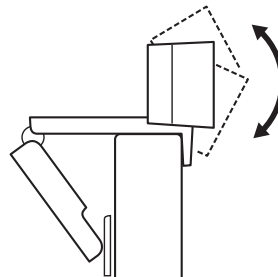

Pokyny pre umiestnenie na statív*

- 1 Nájdite závit statívu ¼ palca na spodku univerzálneho upevňovacieho klipu.

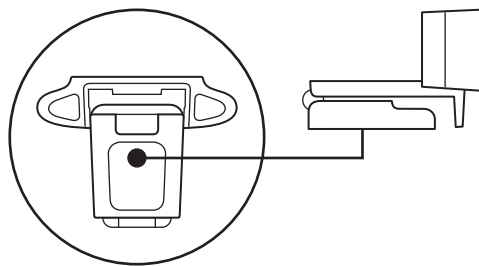

- 2 Upevnite webovú kameru na statív naskrutkovaním na závit ¼ palca.

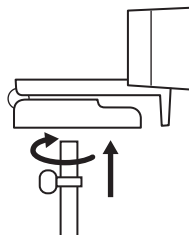

- 3 Umiestnite webovú kameru so statívom na ľubovoľné miesto podľa potreby na dosiahnutie čo najlepšieho záberu.

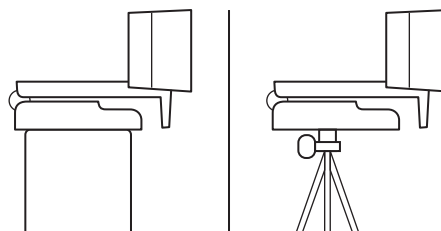

* Statív nie je súčasťou balenia

PRIPOJENIE WEBOVEJ KAMERY PROSTREDNÍCTVOM USB-A

Zapojte USB-A konektor do portu USB-A v počítači.

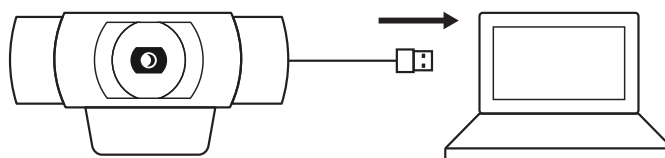

ÚSPEŠNÉ PRIPOJENIE

Keď je webová kamera používaná aplikáciou, indikátor aktivity sa rozsvieti.

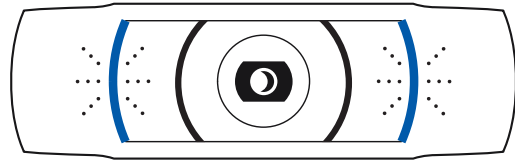

ROZMERY

VRÁTANE UPEVNENÉHO MONTÁŽNEHO KLIPU:

Výška x šírka x hĺbka:

43,3 mm (1,70 in) x 94 mm (3,70 in) x 71 mm (2,80 in)

Dĺžka kábla: 1,5 m (5 ft)

Hmotnosť: 162 g (5,71 oz)

www.logitech.com/support/C920X

ОЗНАЙОМЛЕННЯ З ПРИСТРОЄМ

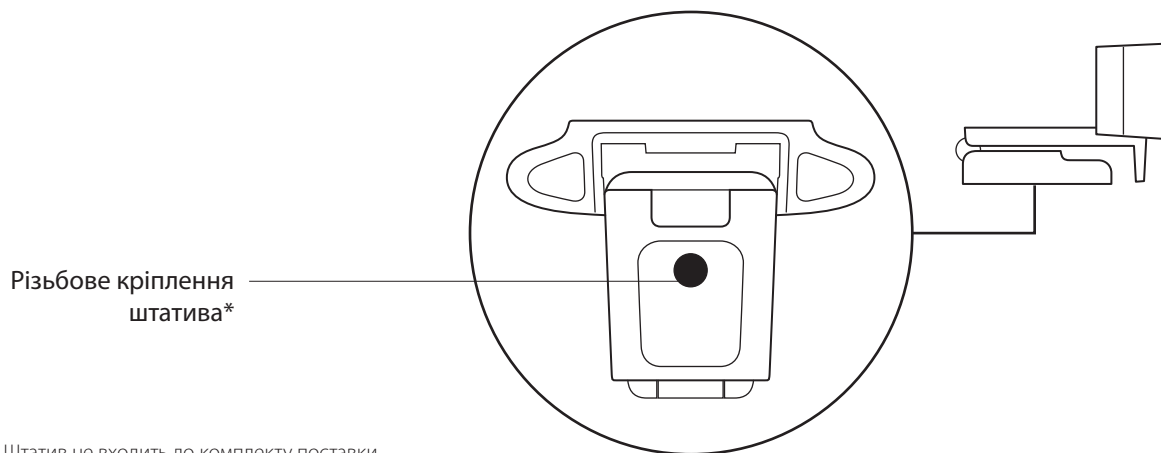
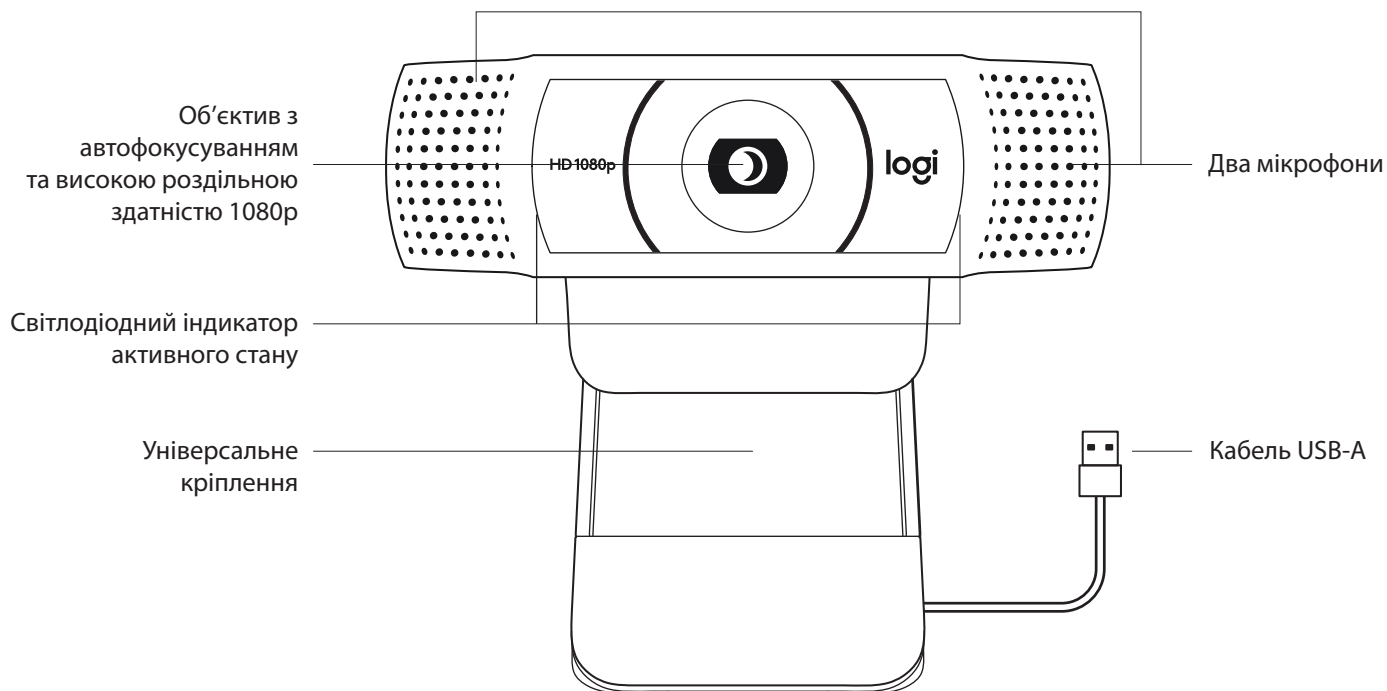

* Штатив не входить до комплекту поставки.

У КОМПЛЕКТІ

- 1 Вебкамера з прикріпленням кабелем USB-A (1,5 м)
- 2 Купон ліцензії XSplit
- 3 Документація користувача

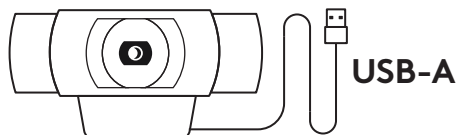

ПІДГОТОВКА ВЕБКАМЕРИ ДО РОБОТИ

Для розташування на моніторі

- 1 Установіть вебкамеру на комп'ютер, ноутбук або монітор у потрібному положенні та під потрібним кутом.



- 2 Відрегулюйте положення вебкамери так, щоб підставка універсального кріплення повністю прилягала до задньої панелі пристрою.

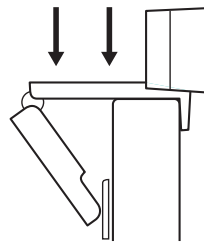

- 3 Відрегулюйте вручну кут нахилу вебкамери, щоб забезпечити оптимальне кадрування.

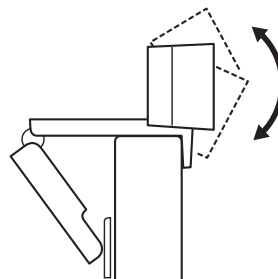

Розташування на штативі*

- 1 Встановіть різьбове кріплення штатива $\frac{1}{4}$ дюйма у нижній частині універсального кріплення.

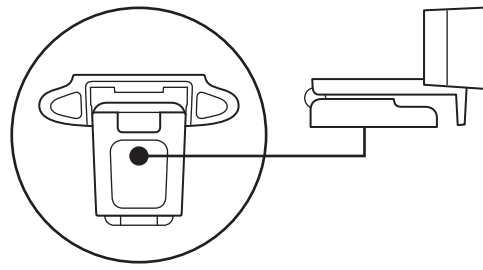

- 2 Закріпіть вебкамеру на штативі за допомогою різьблення $\frac{1}{4}$ дюйма.

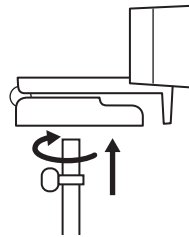

- 3 Розташуйте вебкамеру на штативі в будь-якому місці, де вам буде зручно.

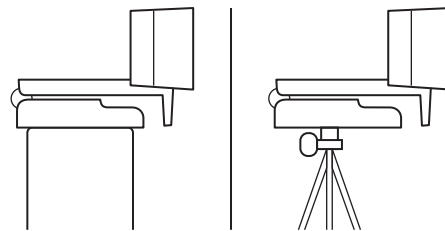

* Штатив не входить до комплекту поставки.

ПІДКЛЮЧЕННЯ ВЕБКАМЕРИ ЗА ДОПОМОГОЮ РОЗ'ЄМУ USB-A

Вставте роз'єм USB-A у відповідний порт комп'ютера.

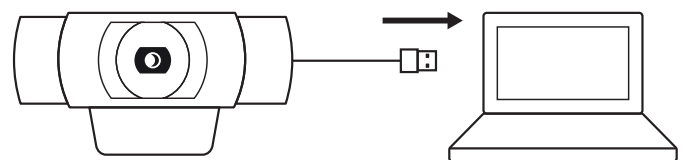

УСПІШНЕ ПІДКЛЮЧЕННЯ

Світлодіодний індикатор активного стану загориться, коли програма використовуватиме вебкамеру.

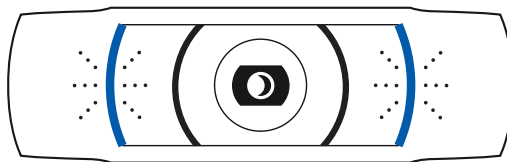

РОЗМІРИ

ЗІ СТАЦІОНАРНИМ КРІПЛЕННЯМ

Висота x ширина x довжина:
43,3 мм x 94 мм x 71 мм

Довжина кабелю: 1,5 м

Вага: 162 г

www.logitech.com/support/C920X

TOOTE TUTVUSTUS

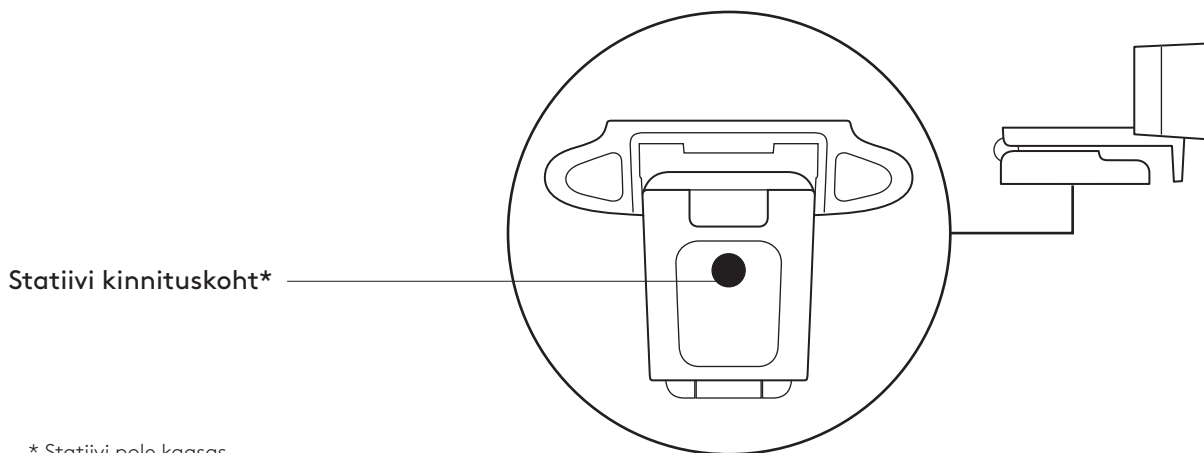
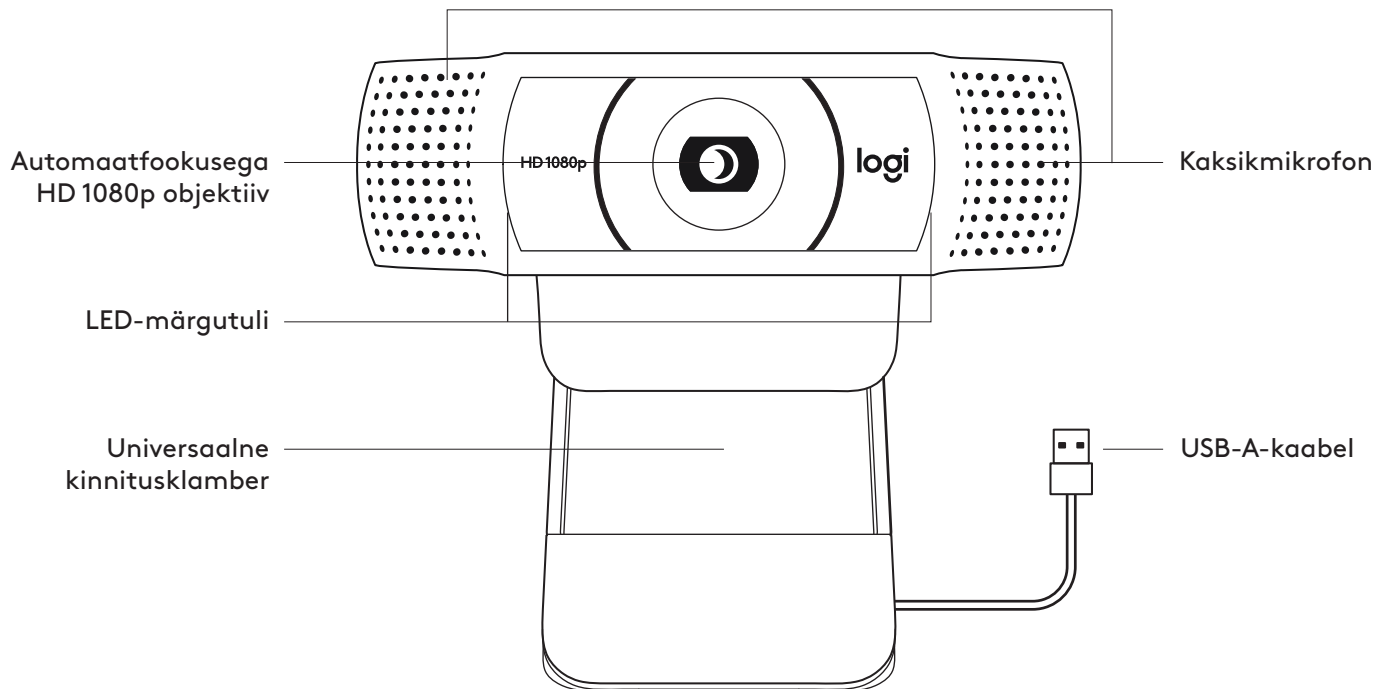

* Statiivi pole kaasas

KARBI SISU

- 1 Veebikaamera koos 1,5 m (1.5 jala) pikkuse USB-A-kaabliga
- 2 XSpliti litsentsi kupong
- 3 Kasutaja dokumentatsioon

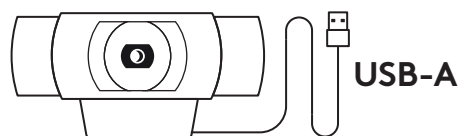

VEEBIKAAMERA SEADISTAMINE

Monitori külge kinnitamiseks

- 1 Asetage veebikaamera arvutile, sülearvutile või monitorile soovitud asendis või nurga all.

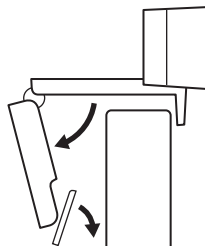

- 2 Reguleerige veebikaamerat ja veenduge, et universaalse kinnitusklambri jalg oleks seadme tagaküljega samal tasapinnal.

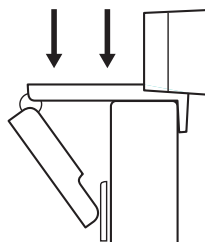

- 3 Reguleerige veebikaamerat käsitsi üles/alla, et saavutada parim asend enda kaadrise püüdmiseks.

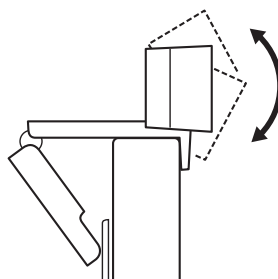

Statiivi* külge kinnitamiseks

- 1 1/4 tolline statiivi kinnituskoht asub universaalse kinnitusklambri alaosas.

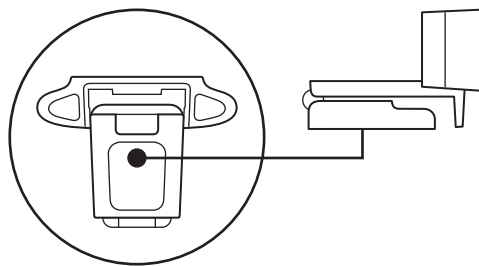

- 2 Kinnitage veebikaamera statiivile, pöörates statiivi 1/4-tollise keerme sisse.

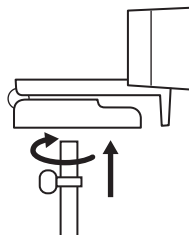

- 3 Asetage statiivil veebikaamera oma soovi järgi enda kõige paremini kaadrisse saamiseks sobivasse asukohta.

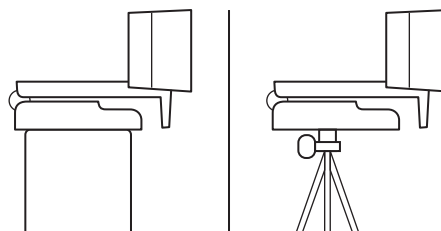

* Statiivi pole kaasas

VEEBIKAAMERA ÜHENDAMINE USB-A KAUDU

Ühendage USB-A pistik oma arvuti USB-A porti.

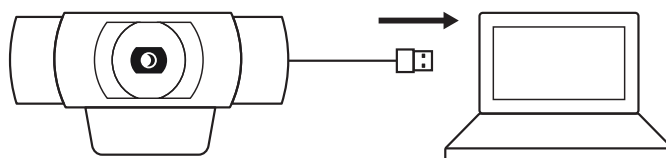

EDUKAS ÜHENDUS

Kui veebikaamerat kasutab mõni rakendus, süttib LED-märgutuli.

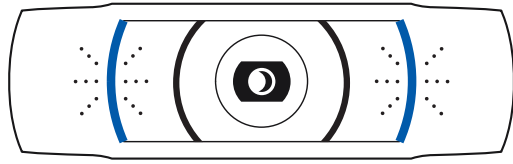

MÕÕDUD

KOOS FIKSEERITUD KINNITUSKLAMBRIGA:

Kõrgus x laius x sügavus:

43,3 mm (1,70 tolli) x 94 mm (3,70 tolli) x 71 mm (2,80 tolli)

Kaabli pikkus: 1,5 m (5 jalga)

Kaal: 162 g (5,71 untsi)

www.logitech.com/support/C920X

IEPAZĪSTIET IERĪCI

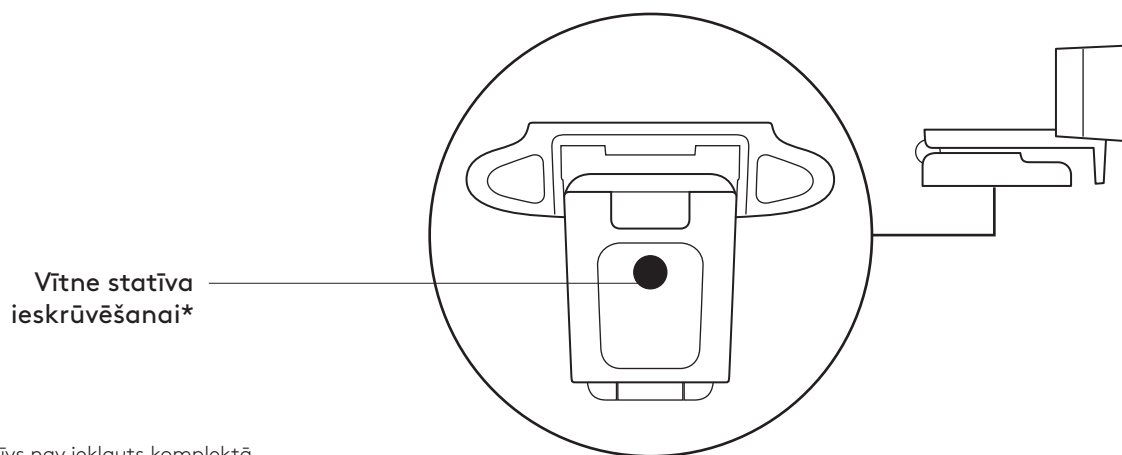
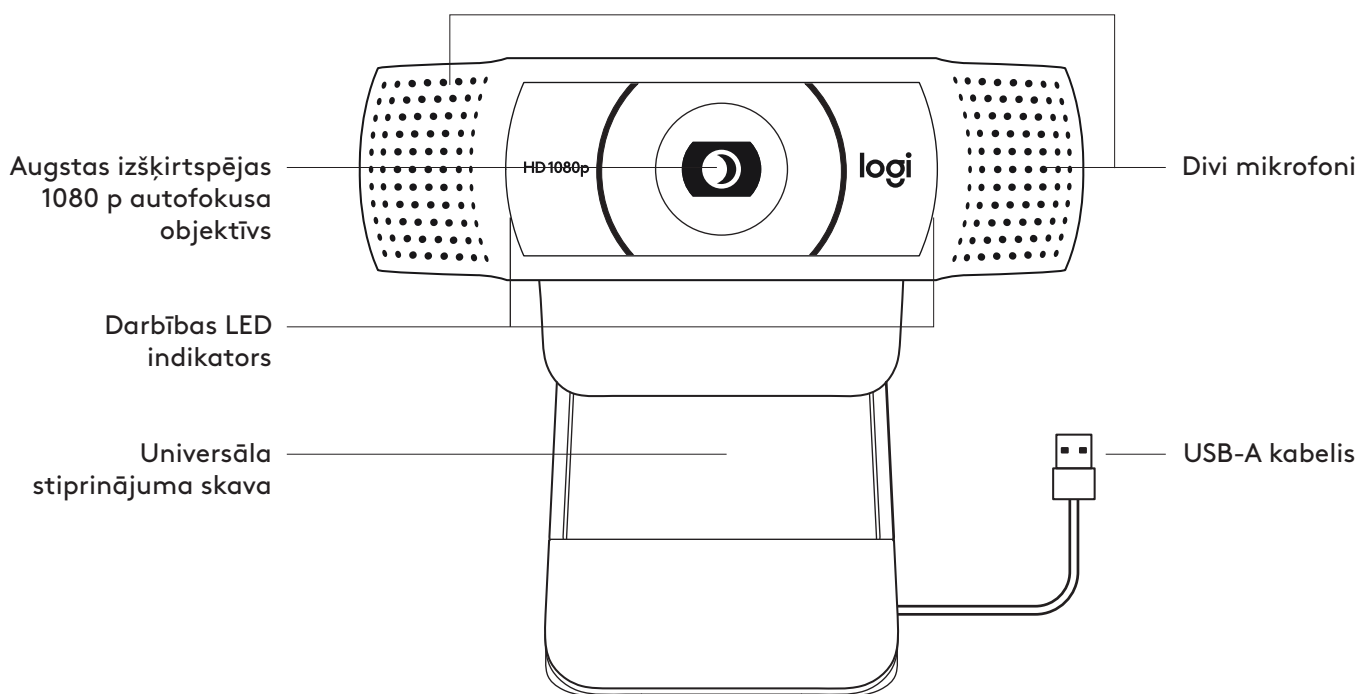

*Statīvs nav iekļauts komplektā

IEPAKOJUMA SATURS

- 1 Tīmekļa kamera ar pievienotu 1,5 m (5 pēdu) USB-A kabeli
- 2 "Xsplit" licences kupons
- 3 Lietotāja dokumentācija

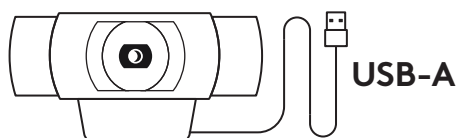

TĪMEKĻA KAMERAS IESTATĪŠANA

Piestiprināšana pie monitora

- 1 Tīmekļkameru nepieciešamajā vietā un leņķī novietojiet uz datora, klēpjdatora vai monitora.

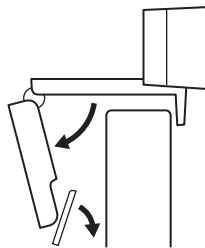

- 2 Pielāgojiet tīmekļkameru, lai pārliecinātos, ka universālās stiprinājuma skavas pamatne cieši pieguļ ierīces aizmugurei.

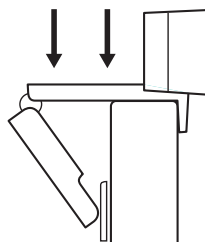

- 3 Manuāli pielāgojiet tīmekļkameru uz augšu un leju līdz labākajai vietai, lai sevi iekadrētu.

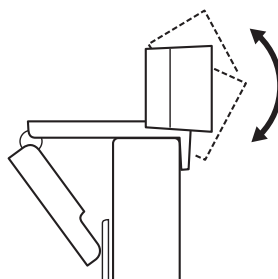

Nostiprināšana uz statīva*

- 1 Atrodiet 1/4 collas statīva stiprinājuma vītņi universālās stiprinājuma skavas apakšā.

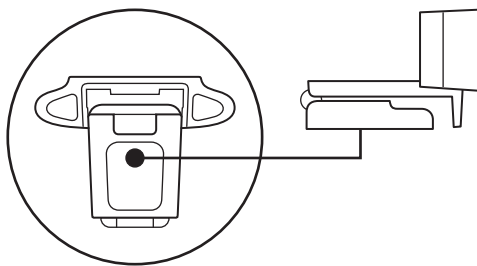

- 2 Piestipriniet tīmekļa kameru pie statīva, ieskrūvējot statīvu 1/4 collas vītņē.

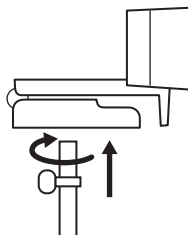

- 3 Novietojiet statīvu ar tīmekļa kameru vēlamajā pozīcijā, lai iegūtu vislabāko attēlu.

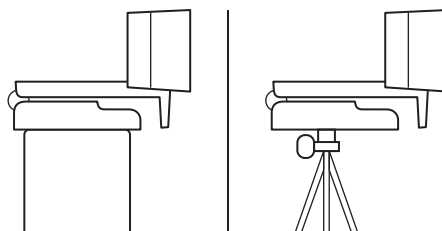

*Statīvs nav iekļauts komplektā

TĪMEKĻA KAMERAS PIESLĒGŠANA, IZMANTOJOT USB-A KABELI

Iespraidiet USB-A savienotāju sava datora USB-A pieslēgvietā.

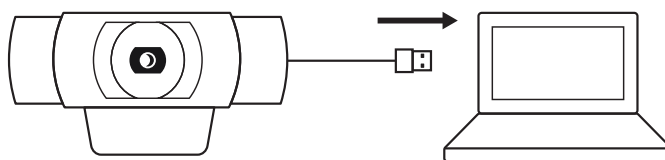

SEKMĪGA PIESLĒGŠANA

Darbības LED indikators iegaismosies,
kad lietojumprogramma izmantos tīmekļkameru.

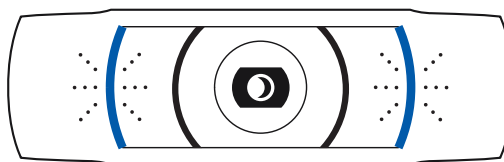

IZMĒRI

IESKAITOT FIKSĒTU STIPRINĀJUMA SKAVU:

augstums x platums x dziļums:
43,3 mm (1,70 collas) x 94 mm (3,70 collas) x 71 mm (2,80 collas)

Kabeļa garums: 1,5 m (5 pēdas)

Svars: 162 g (5,71 unces)

www.logitech.com/support/C920X

SUSIPAŽINKITE SU SAVO PRODUKTU

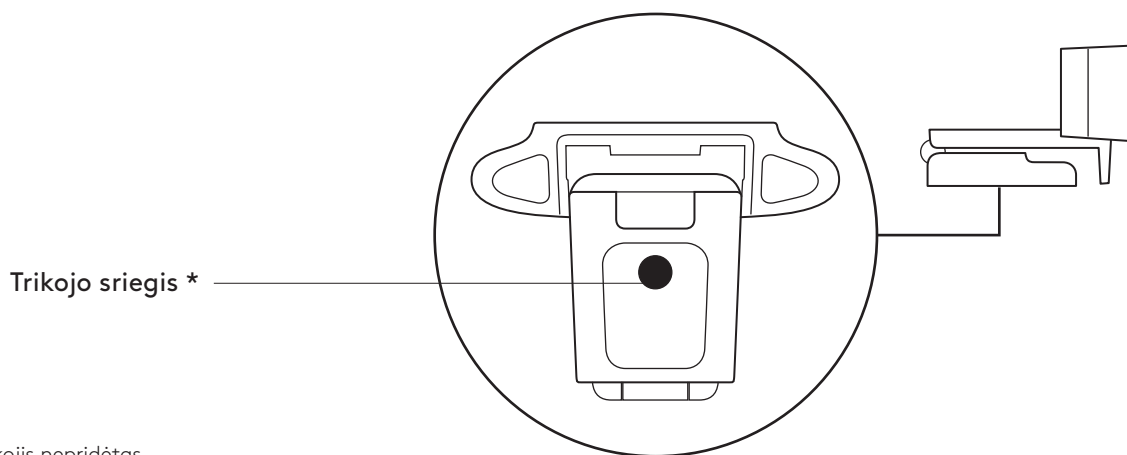
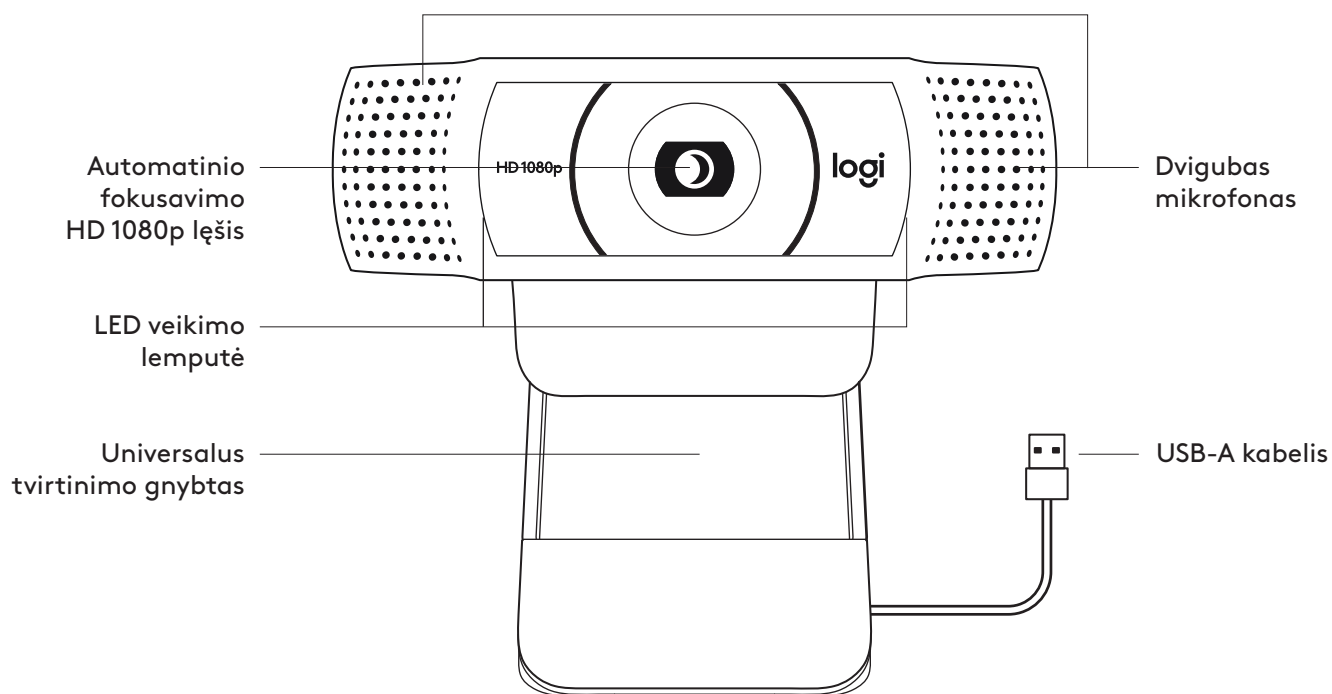

* Trikojis nepridėtas

DĖŽUTĖJE YRA

- 1 Žiniatinklio kamera su 1,5 m (5 pėd.) pritvirtintu USB-A laidu
- 2 „XSplit“ licencijos kuponas
- 3 Naudotojo dokumentacija

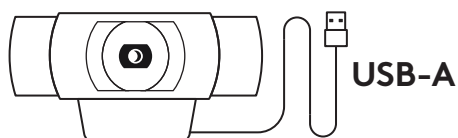

ŽINIATINKLIO KAMEROS PARUOŠIMAS

Ant monitoriaus

- 1 Žiniatinklio kamerą tvirtinkite prie kompiuterio, nešiojamojo kompiuterio arba monitoriaus norimoje padėtyje arba norimu kampu.

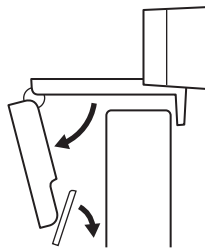

- 2 Sureguliuokite žiniatinklio kamerą, kad universalus tvirtinimo gnybto kojėlė priglustų prie jūsų įrenginio galinės dalies.

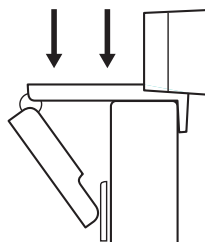

- 3 Ranka reguliuokite žiniatinklio kamerą aukštyn arba žemyn, kol nustatysite geriausią padėtį.

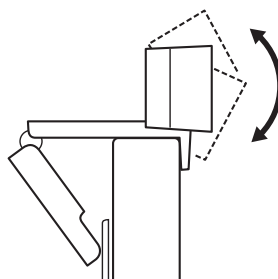

Ant trikojo*

- 1 Raskite ¼ col. trikojo sriegį universalaus tvirtinimo gnybto apačioje.

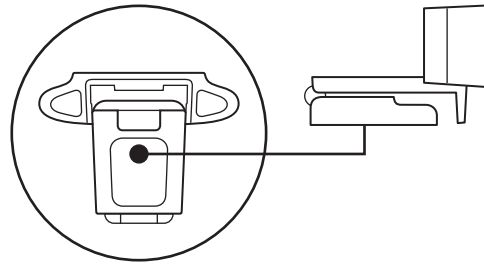

- 2 Žiniatinklio kamerą tvirtinkite prie trikojo prisukdami trikoją prie ¼ col. sriegio.

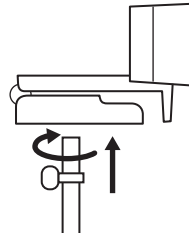

- 3 Padėkite žiniatinklio kamerą su trikoju pageidaujamoje vietoje.

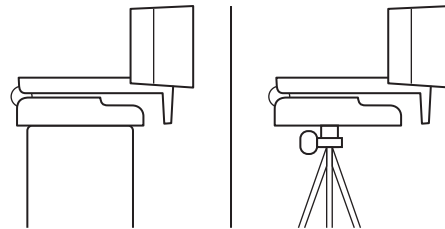

* Trikojis nepridėtas

INTERNETINĖS VAIZDO KAMEROS PRIJUNGIMAS SU USB-A

Įkiškite USB jungtį į savo kompiuterio USB-A prievadą.

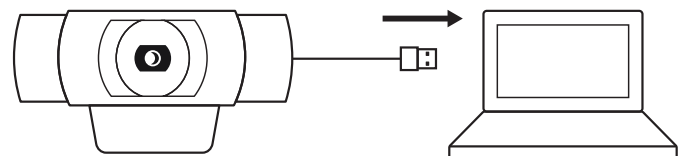

SĖKMINGAS PRIJUNGIMAS

LED veikimo lemputė užsidegs, kai programa naudos žiniatinklio kamerą.

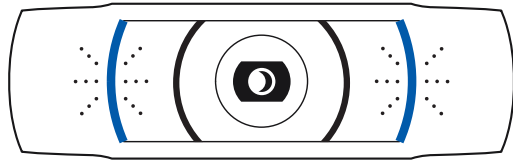

MATMENYS

ĮSKAITANT FIKSUOTĄ TVIRTINIMO GNYBTĄ:

aukštis x plotis x gylis:

43,3 x 94 x 71 mm (1,70 x 3,70 x 2,80 col.)

Laido ilgis: 1,5 m (5 pėd.)

Svoris: 162 g (5,71 unc.)

www.logitech.com/support/C920X

ЗАПОЗНАЙТЕ СЕ СЪС СВОЯ ПРОДУКТ

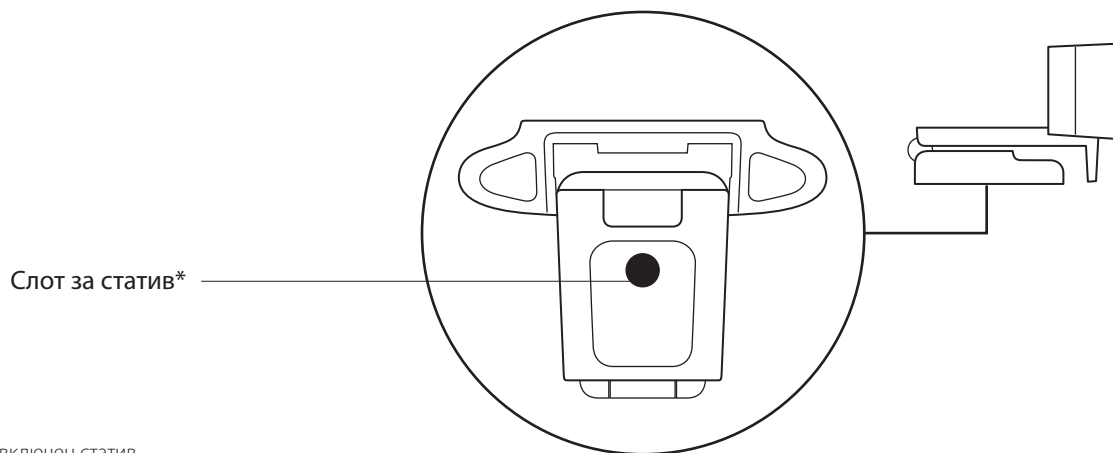
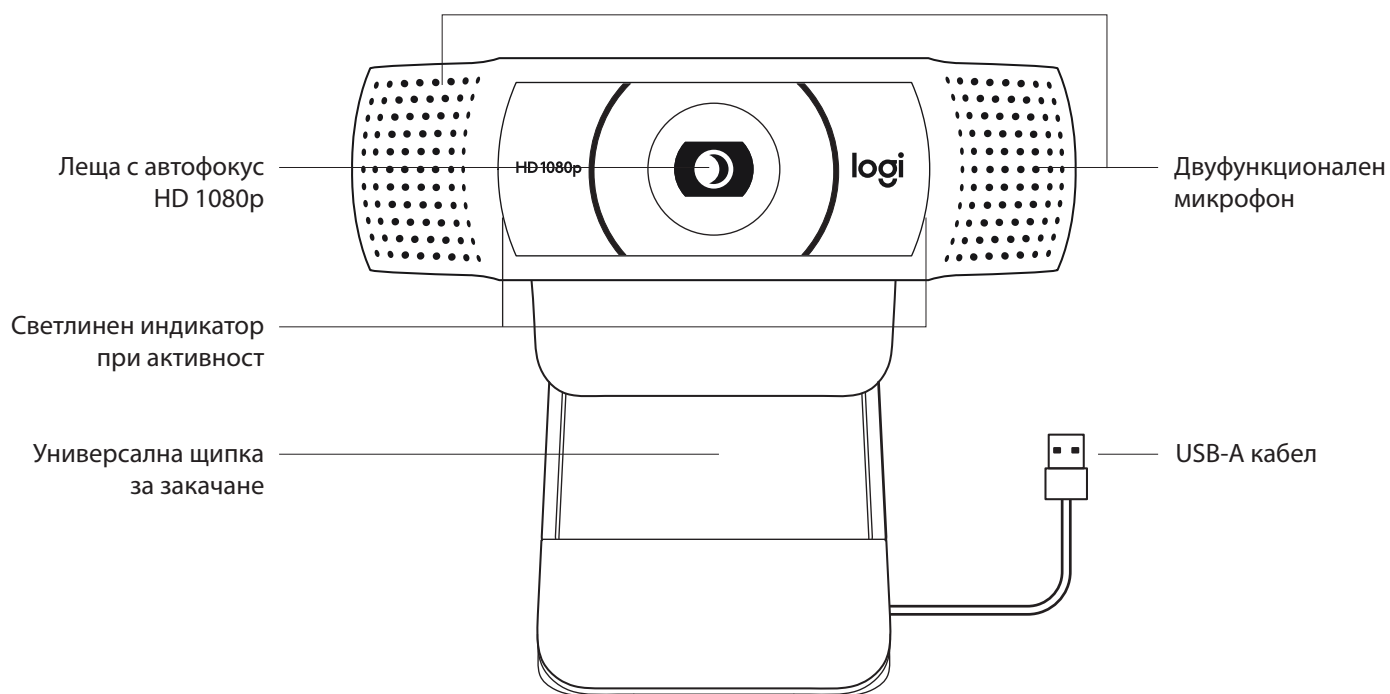

* Не е включен статив

СЪДЪРЖАНИЕ НА КУТИЯТА

- 1 Уеб камера с поставен 5 ft (1,5 м) USB-A кабел
- 2 Талон за лиценз XSplit
- 3 Документация за потребителя

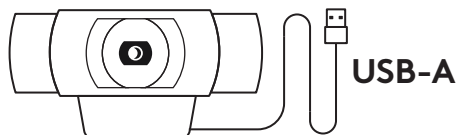

НАСТРОЙКА НА УЕБ КАМЕРАТА

За поставяне на монитор

- 1 Поставете веб камерата върху компютър, лаптоп или монитор в желаното от вас положение или ъгъл.



- 2 Регулирайте веб камерата така, че да сте сигурни, че универсалната щипка за закачане е подравнена с гърба на устройството.

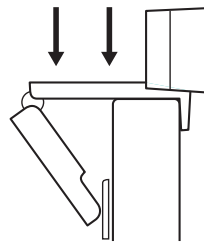

- 3 Регулирайте веб камерата в посока нагоре/надолу, докато откриете най-доброто положение, за да се хванете в кадър.

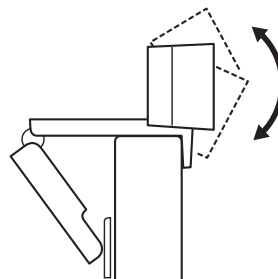

За поставяне върху статив*

- 1 Поставете ¼-инчовото тяло на статива в долната част на универсалната щипка за закачане.

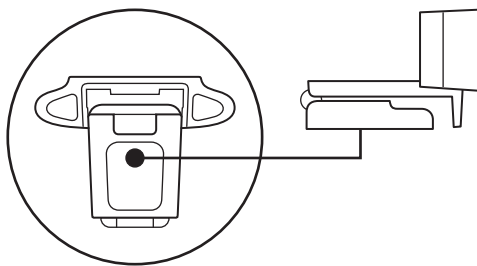

- 2 Застопорете уеб камерата върху статива, като я пъхнете в ¼-инчовия слот.

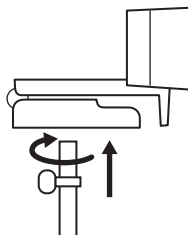

- 3 Поставете уеб камерата със статива, където желаете, за да се позиционирате по най-добрия начин в рамката.

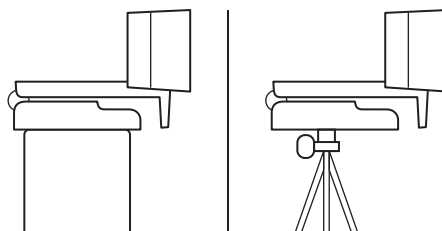

* Не е включен статив

СВЪРЗВАНЕ НА УЕБ КАМЕРАТА ЧРЕЗ USB-A

Включете USB-A конектора в USB-A порта на компютъра ви.

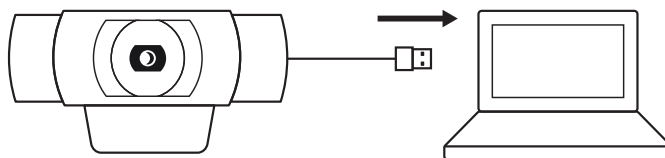

УСПЕШНО СВЪРЗВАНЕ

Светлинният индикатор ще светне, когато уеб камерата се използва от приложение.

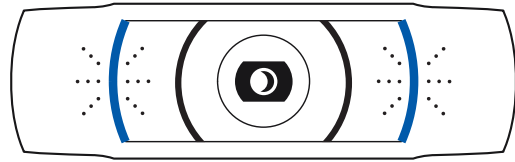

РАЗМЕРИ

ВКЛЮЧВА ЩИПКА ЗА ФИКСИРАНО ЗАКАЧАНЕ:

Височина x ширина x дълбочина:
1,70 in (43,3 мм) x 3,70 in (94 мм) x 2,80 in (71 мм)

Дължина на кабела: 5 ft (1,5 м)

Тегло: 5,71 oz (162 г)

www.logitech.com/support/C920X

UPOZNAJTE SVOJ UREĐAJ

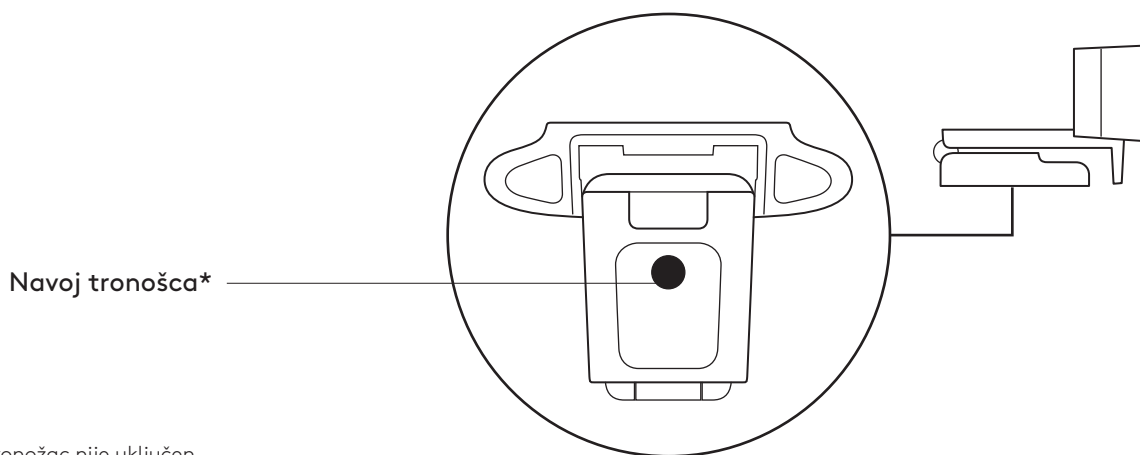
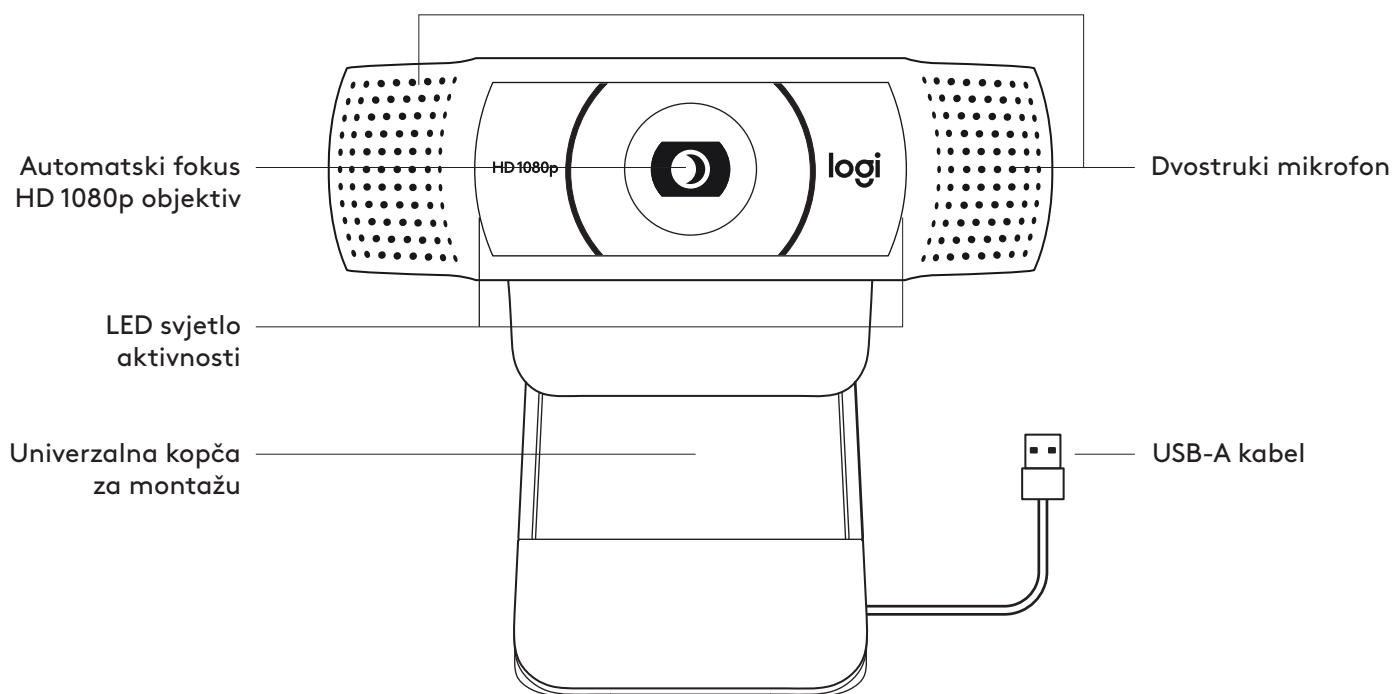

* Tronožac nije uključen

SADRŽAJ KUTIJE

- 1 Web kamera s priključnim USB-A kablom od 1,5 m (5 ft)
- 2 Kupon za XSplit licencu
- 3 Korisnička dokumentacija

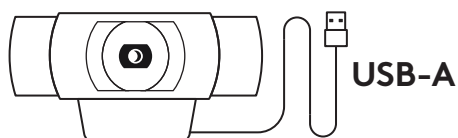

POSTAVLJANJE WEB KAMERE

Postavljanje na monitor

- 1 Stavite web kameru na stolno/prijenosno računalo ili na monitor na mjesto i u položaj po vašoj želji.



- 2 Prilagodite web kameru tako da podnožje univerzalne kopče za montažu bude poravnato sa stražnjom stranom uređaja.



- 3 Ručno podesite web kameru u vertikalnom smjeru dok ne dobijete položaj s vašom najboljom slikom.

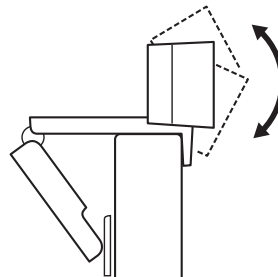

Postavljanje na tronožac*

- 1 Pronađite na tronošcu navoj od 6,35 mm (¼ inča) na donjem dijelu univerzalne kopče za montažu.

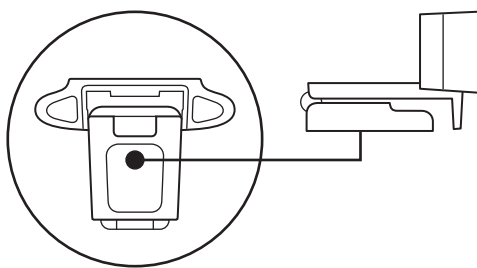

- 2 Pričvrstite web kameru na tronožac uvrtanjem u navoj od 6,35 mm (¼ inča).

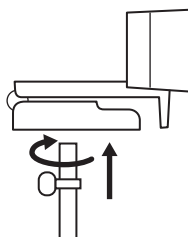

- 3 Postavite kameru s tronošcem na bilo koje mjesto po želji gdje ćete najbolje biti u kadru.

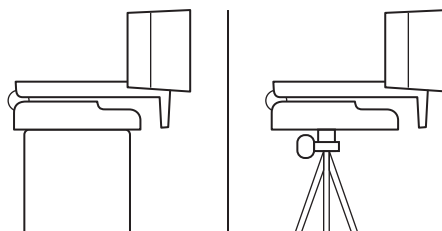

* Tronožac nije uključen

SPAJANJE WEB KAMERE PREKO USB-A PRIKLJUČKA

Priključite USB-A priključak u USB-A utičnicu vašeg računala.

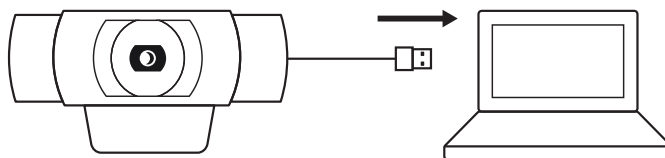

USPJEŠNA VEZA

LED svjetlo aktivnosti će zasvijetliti kada neka aplikacija upotrebljava web kameru.

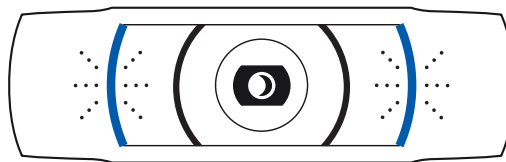

DIMENZIJE

ZAJEDNO S KOPČOM ZA FIKSNU MONTAŽU:

Visina x širina x dubina:

43,3 mm (1,70 inča) x 94 mm (3,70 inča) x 71 mm (2,80 inča)

Duljina kabela: 1,5 m (5 ft)

Težina: 162 g (5,71 oz)

www.logitech.com/support/C920X

UPOZNAJTE SVOJ PROIZVOD

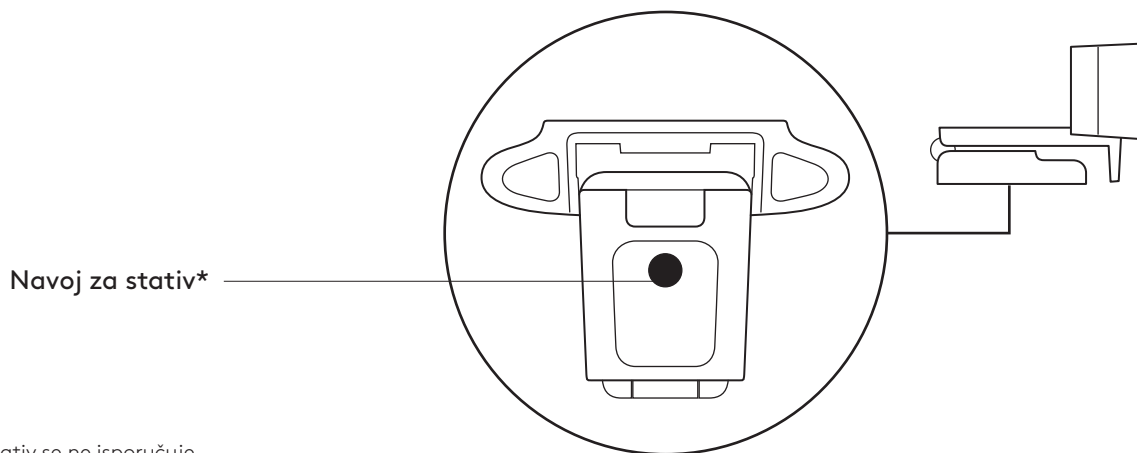
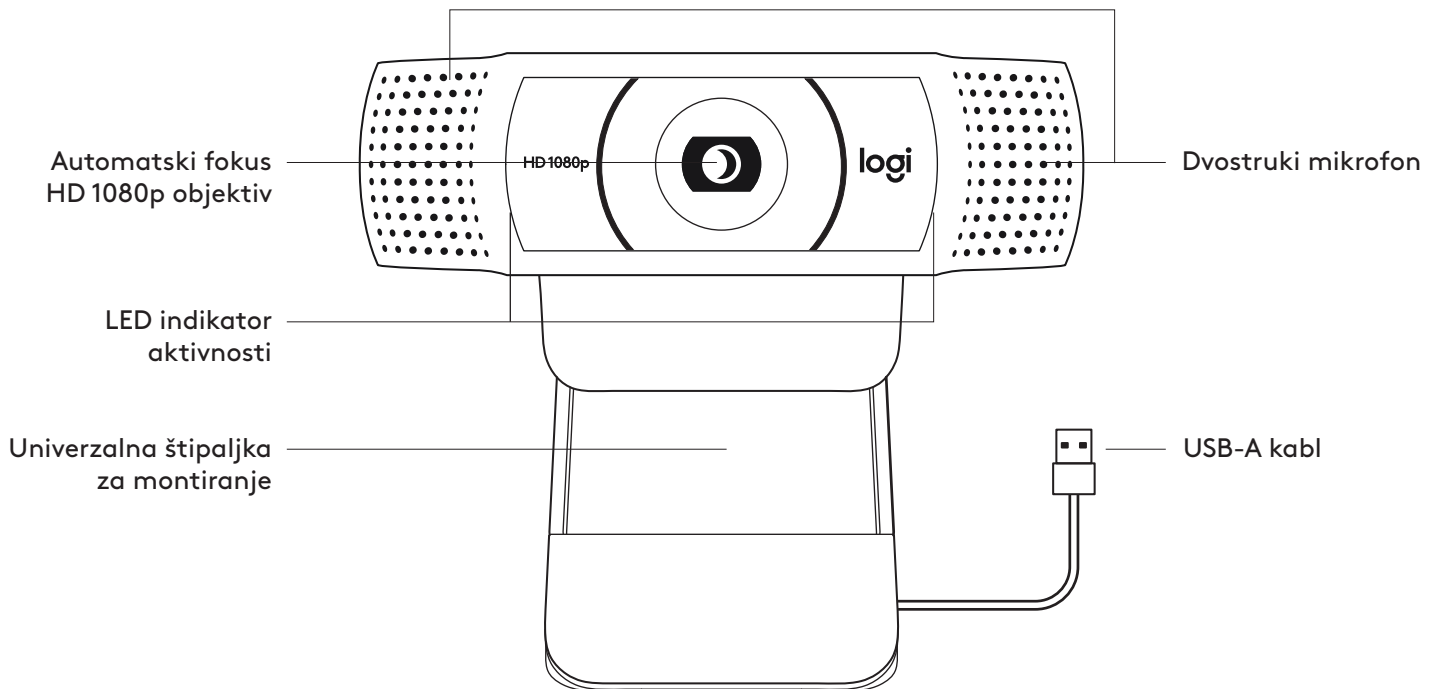

* Stativ se ne isporučuje

SADRŽAJ PAKOVANJA

- 1 Veb kamera sa povezanim USB-A kablom od 1,5 m (5 stopa)
- 2 Kupon za XSplit licencu
- 3 Dokumentacija za korisnika

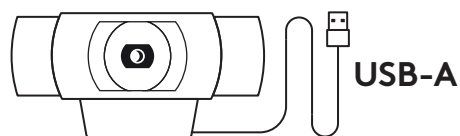

PODEŠAVANJE VEB KAMERE

Za postavljanje na monitor

- 1 Postavite veb kameru na računar, laptop ili monitor pod željenim uglom.



- 2 Podesite veb kameru tako da postolje univerzalne štikaljke za montiranje bude u ravni sa zadnjom stranom uređaja.

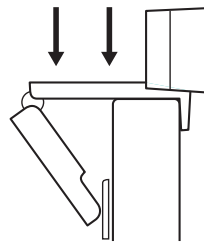

- 3 Ručno pomerajte veb kameru gore/dole u najbolji položaj, tako da vi budete u kadru.

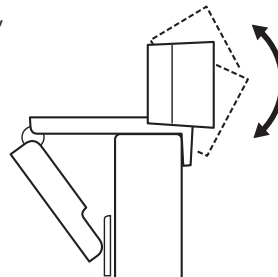

Za postavljanje na stativ*

- 1 Pronađite navoj za stativ od 6,35 mm (¼ inča) na donjem delu univerzalne stezaljke za montiranje.

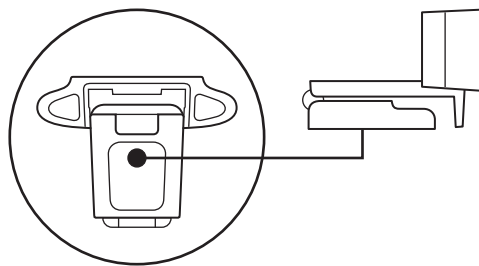

- 2 Pričvrstite veb kameru na stativ privrtanjem stativa na navoj od 6,35 mm (¼ inča).

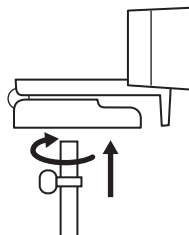

- 3 Postavite veb kameru sa stativom na željeno mesto i u najbolji položaj, tako da vi budete u kadru.

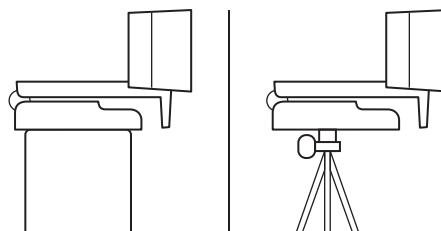

* Stativ se ne isporučuje

POVEZIVANJE VEB KAMERE UZ USB-A

Povežite USB-A konektor na USB-A port na računaru.

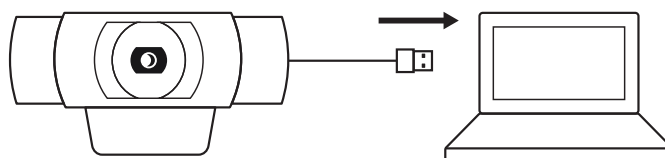

USPEŠNO POVEZIVANJE

LED indikator aktivnosti se uključuje kada neka aplikacija koristi veb kameru.

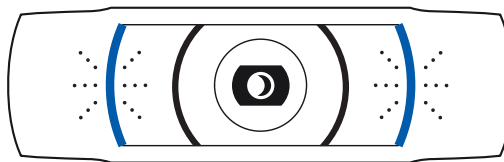

DIMENZIJE

UKLJUČUJUĆI FIKSNU ŠTIPALJKU ZA MONTIRANJE:

Visina x širina x dužina:

43,3 mm (1,70 inča) x 94 mm (3,70 inča) x 71 mm (2,80 inča)

Dužina kabla: 1,5 m (5 stopa)

Težina: 162 g (5,71 unci)

www.logitech.com/support/C920X

SPOZNAJTE IZDELEK

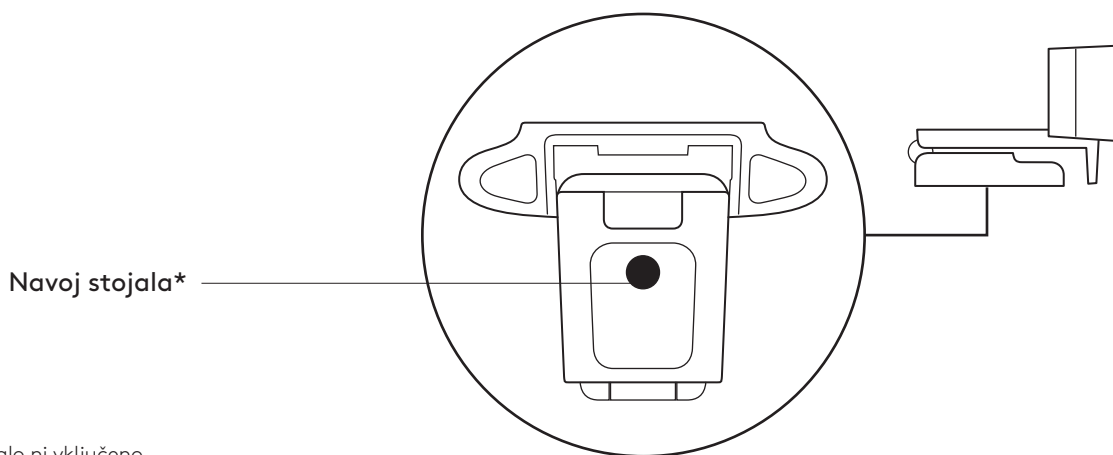
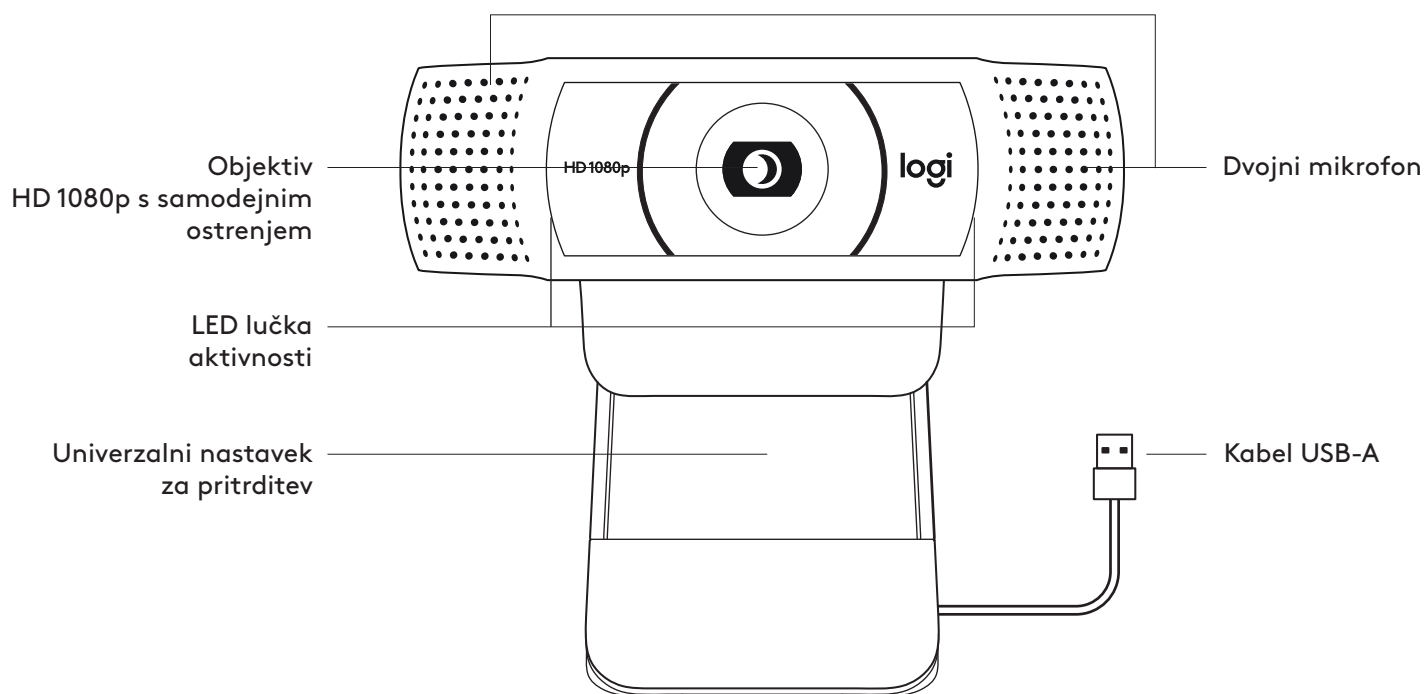

* Stojalo ni vključeno

VSEBINA PAKETA

- 1 Spletna kamera s 1,5 m (5 ft) pritrjenim kablom USB-A
- 2 Kupon za licenco XSplit
- 3 Uporabniška dokumentacija

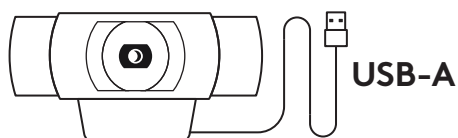

NAMESTITEV SPLETNE KAMERE

Namestitev na zaslon

- 1 Namestite spletno kamero na računalnik, prenosnik ali monitor v želeni položaj ali kot.



- 2 Prilagodite spletno kamero tako, da bo noga na univerzalnem nastavku za pritrnitev poravnana s hrbtno stranjo vaše naprave.



- 3 Spletno kamero ročno nastavite v smeri gor/dol v najboljši položaj, da ste v okvirju.

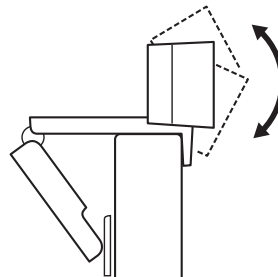

Namestitev na stojalo*

- 1 Poiščite 6,35 mm (¼-palčni) navoj stojala na dnu univerzalnega nastavka za pritrnitev.

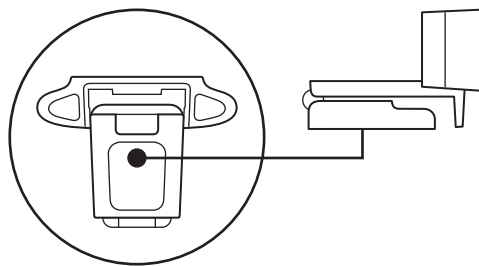

- 2 Spletno kamero pritrдите na stojalo tako, da jo zasukate v 6,35 mm (¼-palčni) navoj.

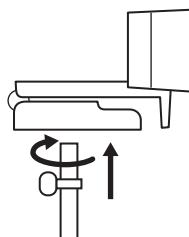

- 3 Vašo kamero s stojalom postavite kamor koli želite, v najboljši položaj, da ste v kadru.

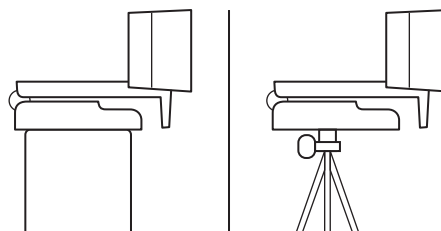

* Stojalo ni vključeno

POVEZOVANJE SPLETNE KAMERE PREK USB-A

Priključek USB-A priključite v vrata USB-A na računalniku.

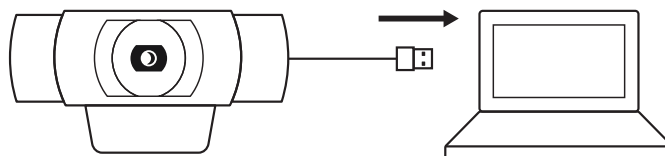

USPEŠNA POVEZAVA

LED lučka aktivnosti bo zasvetila, ko aplikacija uporablja spletno kamero.

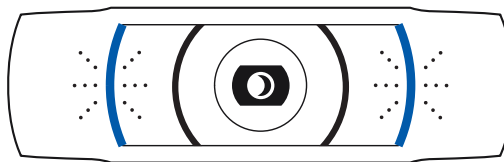

DIMENZIJE

VKLJUČNO S FIKSNIM NASTAVKOM ZA PRITRDITEV:

Višina × širina × globina:

43,3 mm (1,70 in) x 94 mm (3,70 in) x 71 mm (2,80 in)

Dolžina kabla: 1,5 m (5 ft)

Teža: 162 g (5,71 oz)

www.logitech.com/support/C920X

FAMILIARIZAȚI-VĂ CU PRODUSUL

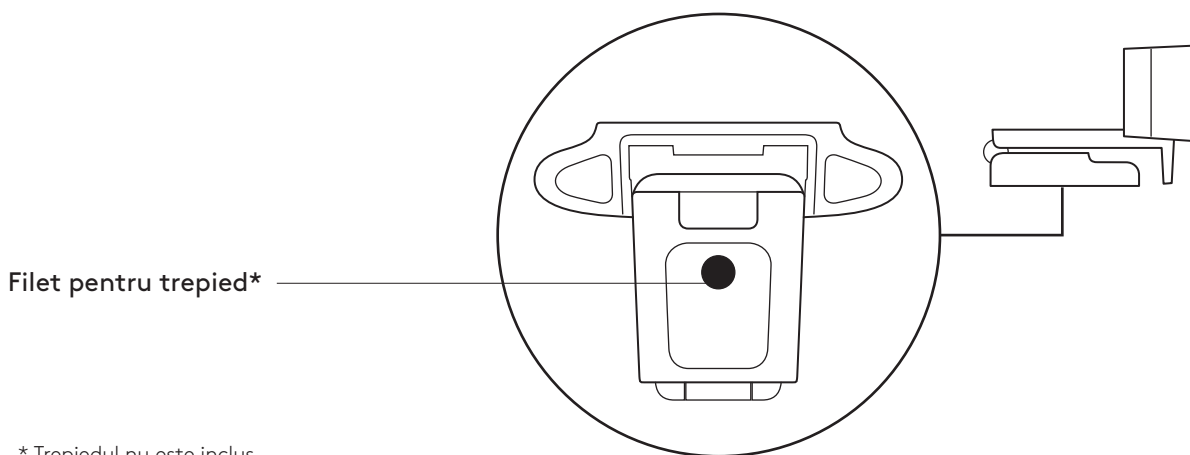
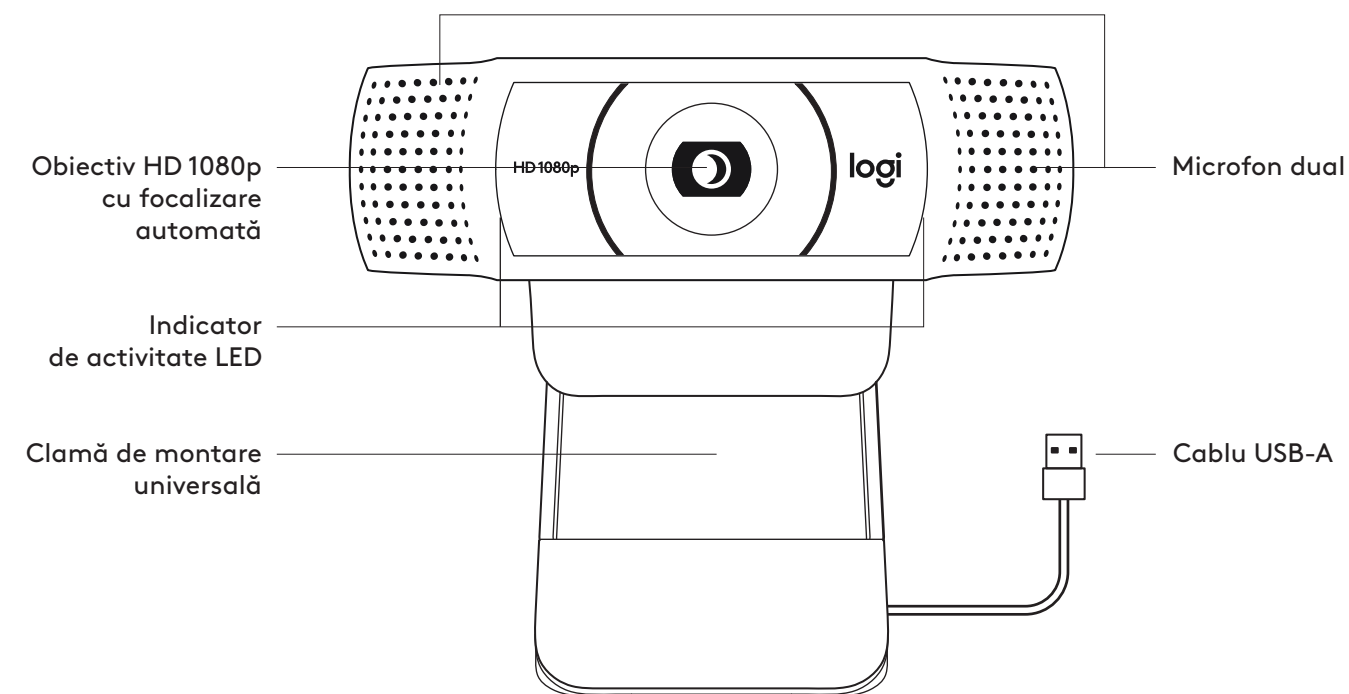

* Trepiedul nu este inclus

CONȚINUTUL CUTIEI

- 1 Cameră web cu cablu USB-A de 1,5 m (5 ft) atasat
- 2 Cupon de licență XSplit
- 3 Documentație pentru utilizator

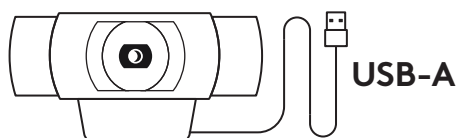

CONFIGURAREA CAMEREI

Pentru plasarea pe monitor

- 1 Plasați camera web pe un computer, laptop sau monitor în poziția sau unghiul dorit.



- 2 Reglați camera pentru a vă asigura că piciorul clamei de montare universale este aliniat la partea din spate a dispozitivului dvs.

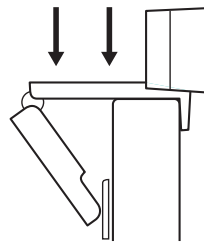

- 3 Reglați manual camera web în sus/jos în cea mai bună poziție pentru a vă încadra.

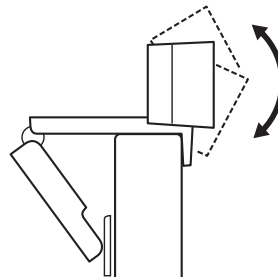

Pentru plasarea pe trepied*

- 1 Găsiți filetul de ¼ inchi pentru trepied în partea de jos a clamei de montare universale.

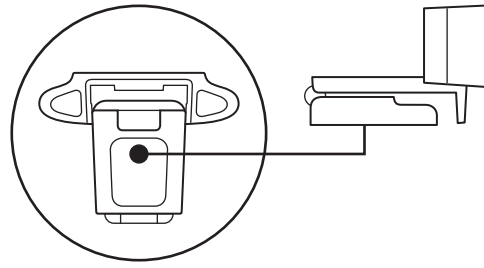

- 2 Prindeți camera web de trepied rotind trepiedul în filetul de ¼ inchi.

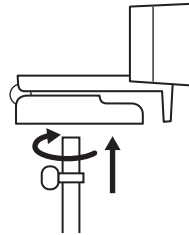

- 3 Plasați camera web cu trepiedul în cea mai bună poziție din care doriți să vă înregistrați.

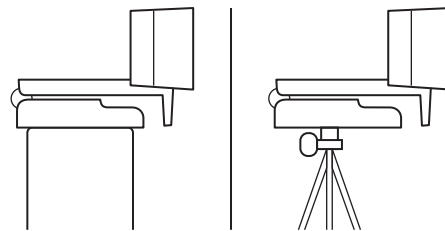

* Trepiedul nu este inclus

CONECTAREA CAMEREI WEB PRIN USB-A

Introduceți conectorul USB-A în portul USB-A al computerului.

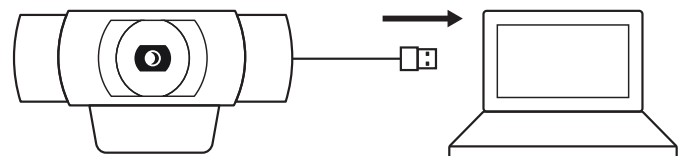

CONEXIUNE REUȘITĂ

Indicatorul de activitate LED se va aprinde când camera web este utilizată de o aplicație.

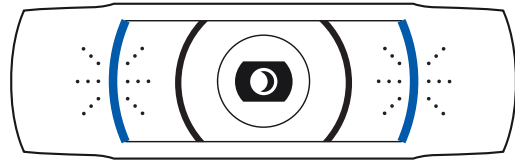

DIMENSIUNI

INCLUSIV CLAMA DE MONTARE FIXĂ:

Înălțime x lățime x adâncime:

43,3 mm (1,70 inchi) x 94 mm (3,70 inchi) x 71 mm (2,80 inchi)

Lungimea cablului: 1,5 m (5 ft)

Greutate: 162 g (5,71 oz)

www.logitech.com/support/C920X

ÜRÜNÜZÜ TANIYIN

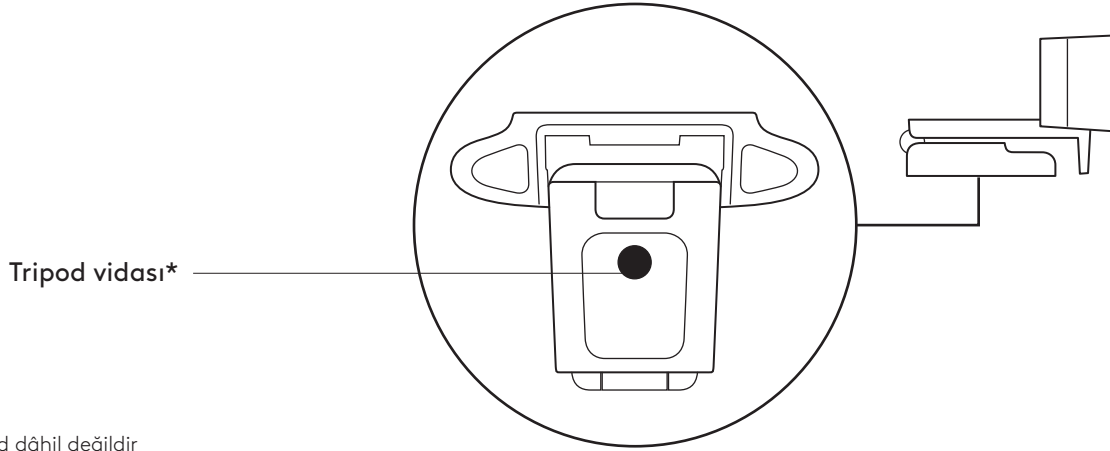
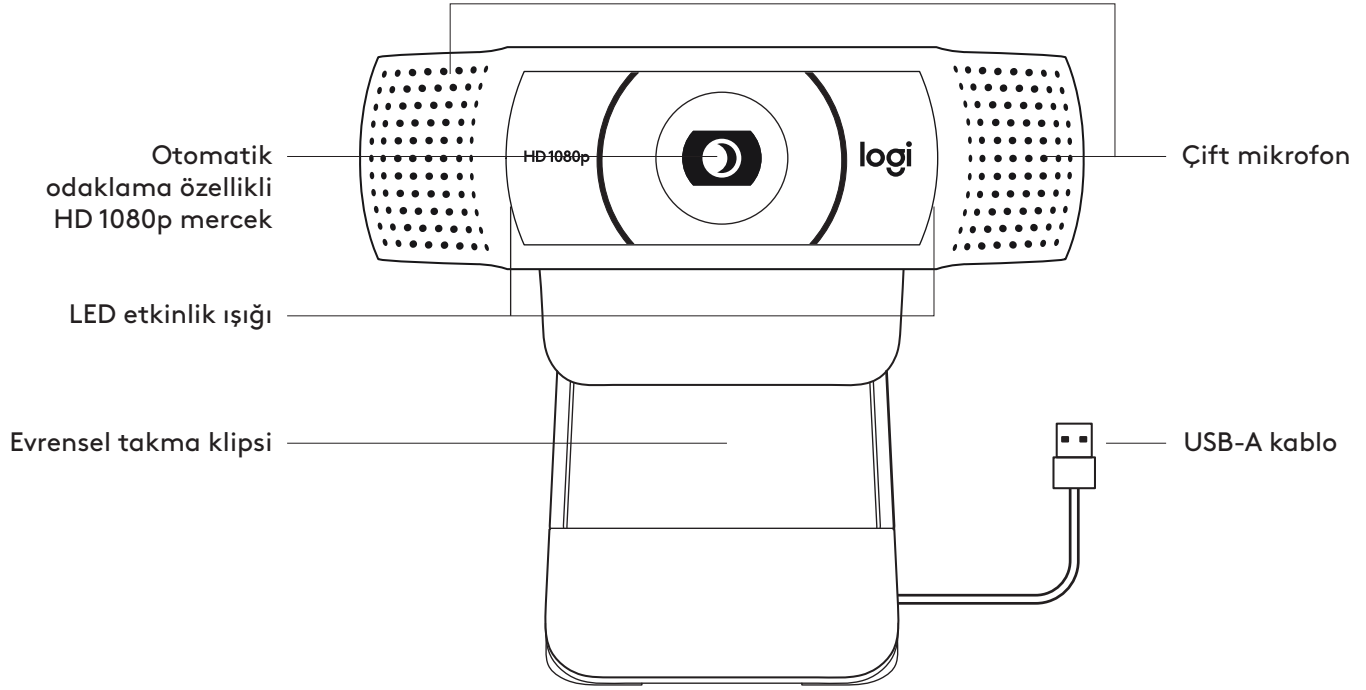

* Tripod dâhil değildir

KUTU İÇERİĞİ

- 1,5 m (5 fit) USB-A kabloya sahip web kamerası
- XSplit lisansı kuponu
- Kullanıcı belgeleri

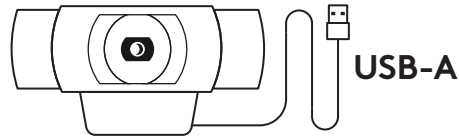

WEBCAM KURULUMU

Monitöre yerleřtirmek için

- 1 Web kameranızı bir bilgisayara, dizüstü bilgisayara veya monitöre istediđiniz bir konum veya açıda yerleřtirin.

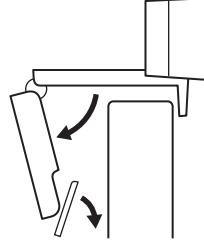

- 2 Evrensel montaj klipsindeki ayađın cihazınızın arkasıyla aynı hizada olduđundan emin olarak web kameranızı ayarlayın.

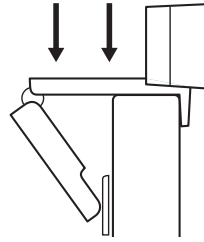

- 3 Kendinizi kamera çerçevesinin içine alacak şekilde web kameranızı yukarı/ařađı ayarlayarak en iyi konuma getirin.

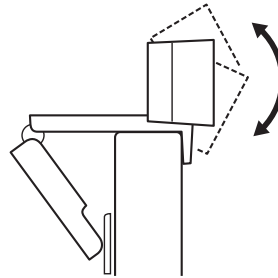

Tripoda yerleřtirmek için*

- 1 ¼ inç tripod vidasını, evrensel montaj klipsinin alt kısmına yerleřtirin.

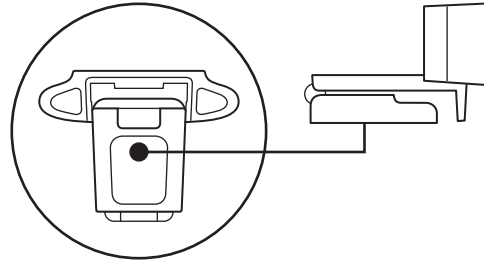

- 2 Tripodunuzu ¼ inç vidaya dođru çevirerek web kamerasını tripodla sabitleyin.

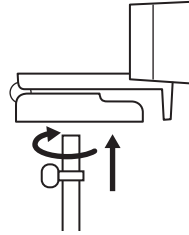

- 3 Kendinizi kamera çerçevesinin içine almak için web kamerasını tripodla birlikte dilediđiniz yerde en iyi konuma yerleřtirin.

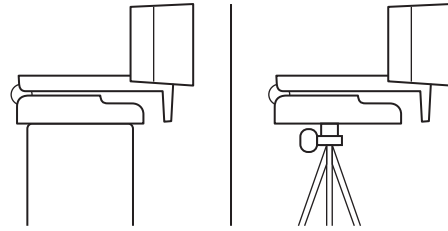

* Tripod dâhil deđildir

WEB KAMERASININ USB-A İLE BAđLANMASI

USB-A konnektörünü bilgisayarınızın USB-A bađlantı noktasına takın.

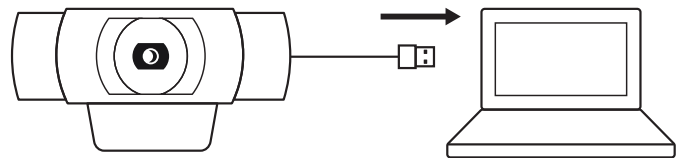

BAŞARILI BAĞLANTI

Web kamerası bir uygulama tarafından kullanıldığında LED etkinlik ışığı yanar.

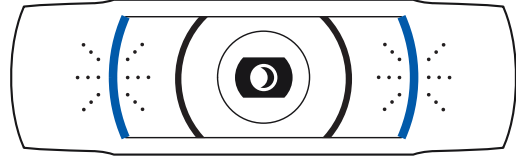

BOYUTLAR

SABİT MONTAJ KLİPSİ İLE BİRLİKTE:

Yükseklik x Genişlik x Derinlik:

1,70 inç (43,3 mm) x 3,70 inç (94 mm) x 2,80 inç (71 mm)

Kablo Uzunluğu: 1,5 m (5 fit)

Ağırlık: 162 g (5,71 ons)

www.logitech.com/support/C920X

التعرُّف على المنتج

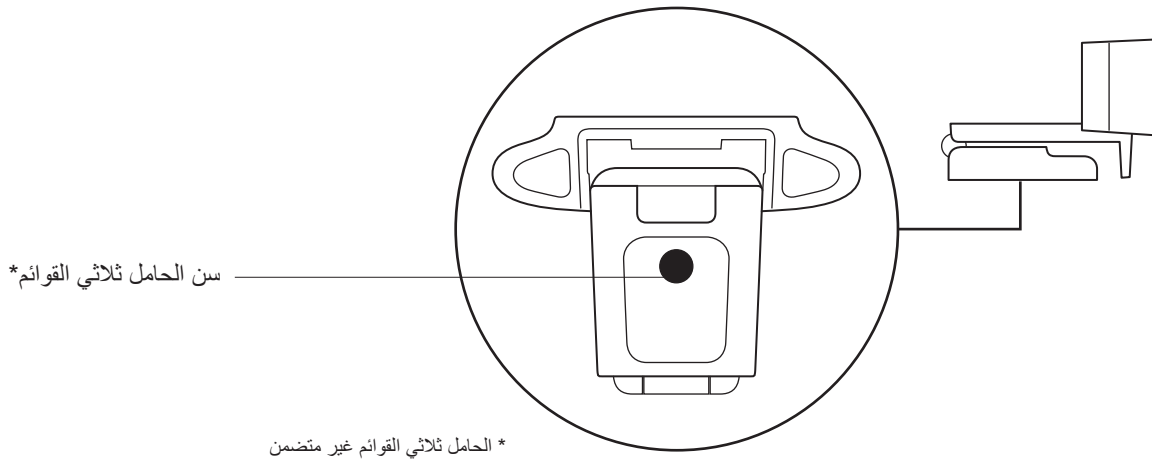
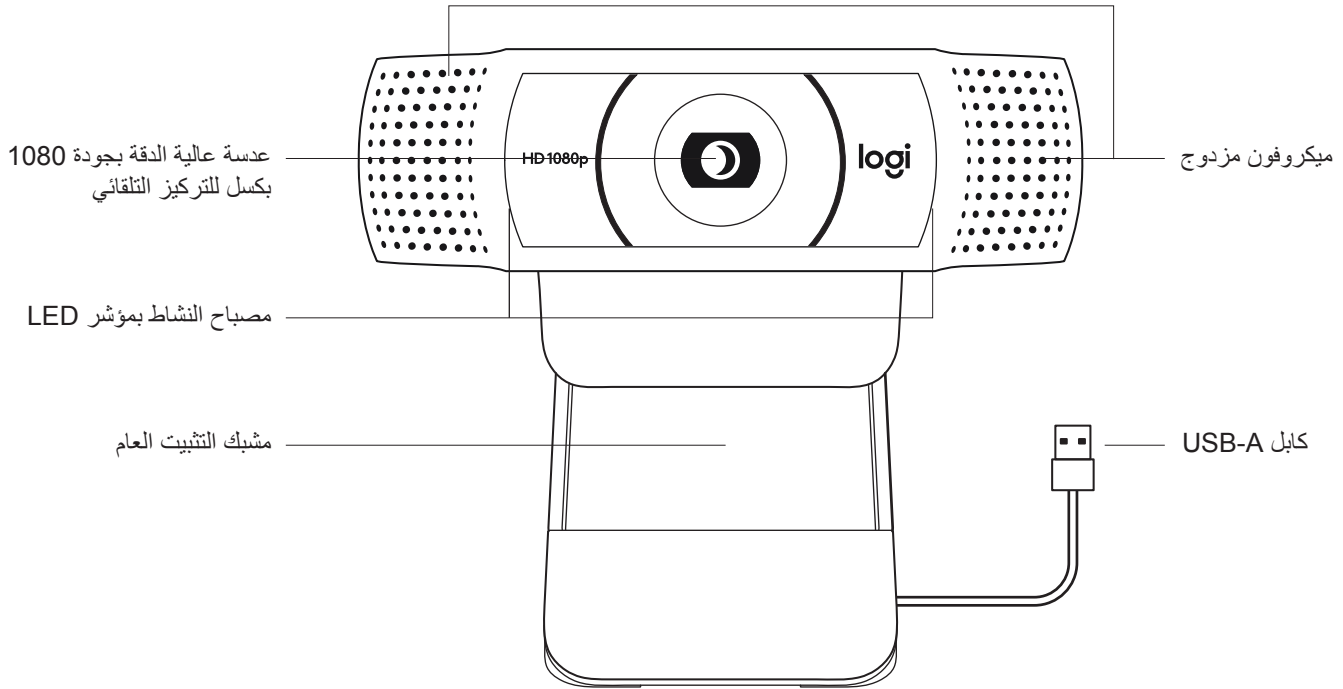

محتويات العبوة

- 1 كاميرا ويب مزودة بكابل USB-A بطول 5 أقدام (1.5 متر)
- 2 كوبون ترخيص XSplit
- 3 وثائق المستخدم

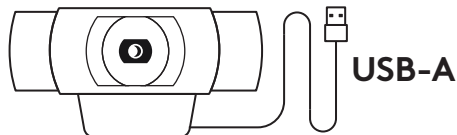

USB-A



إعداد كاميرا الويب

بالنسبة للوضع على الشاشة

1 ضع كاميرا الويب على جهاز كمبيوتر أو كمبيوتر محمول أو شاشة في الموضع أو الزاوية التي تريدها.

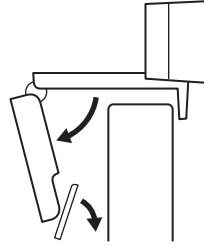

2 اضبط كاميرا الويب للتأكد من أن القدم الموجودة بمشبك التثبيت العام متحاذاة مع الجزء الخلفي من جهازك.

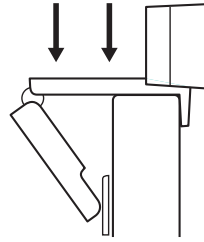

3 اضبط كاميرا الويب يدويًا لأعلى/لأسفل على أفضل وضعية لجعل نفسك داخل الإطار.

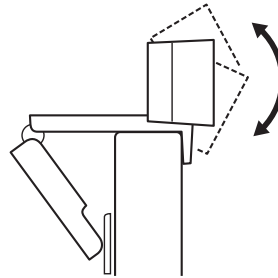

بالنسبة للوضع على الحامل ثلاثي القوائم*.

1 حدد موقع سن الحامل ثلاثي القوائم مفاص 4/1 بوصة في الجزء السفلي من مشبك التثبيت العام.

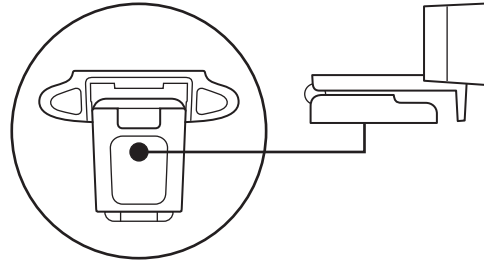

2 قم بتثبيت كاميرا الويب على الحامل ثلاثي القوائم من خلال لف الحامل ثلاثي القوائم في السن مفاص 1/4 بوصة.

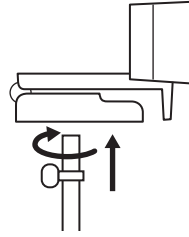

3 ضع كاميرا الويب مع الحامل ثلاثي القوائم في أي مكان تريده في أفضل وضعية لجعل نفسك داخل الإطار.

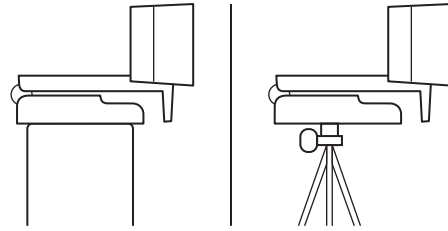

* الحامل ثلاثي القوائم غير متضمن

توصيل كاميرا الويب من خلال USB-A

قم بتوصيل موصل USB-A بمنفذ USB-A الموجود على جهاز الكمبيوتر لديك.

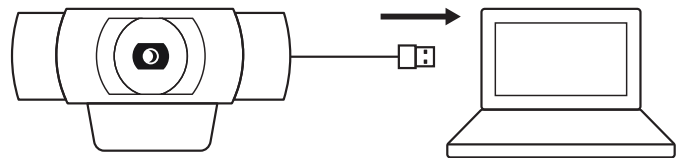

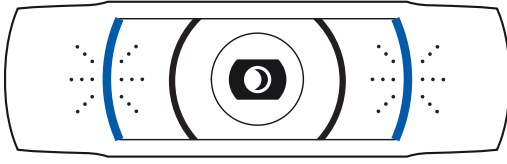

التوصيل الناجح

سيضيء مصباح النشاط بمؤشر LED عند استخدام كاميرا الويب بواسطة أحد التطبيقات.

الأبعاد

بما في ذلك مشبك التثبيت الثابت:

الطول × العرض × العمق:

1.70 بوصة (43.3 ملم) × 3.70 بوصة (94 ملم) × 2.80 بوصة (71 ملم)

طول الكابل: 5 أقدام (1.5 م)

الوزن: 5.71 أونصات (162 جم)

www.logitech.com/support/C920X

הכר את המוצר

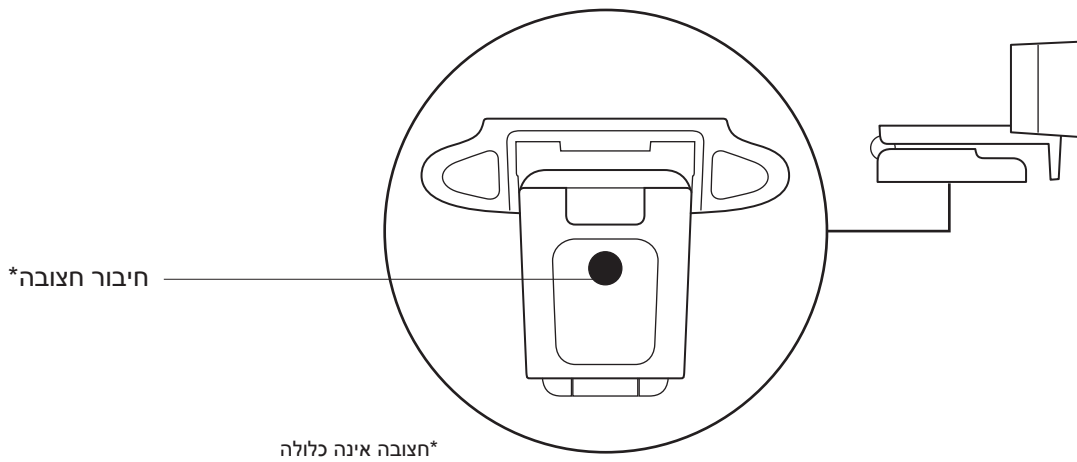
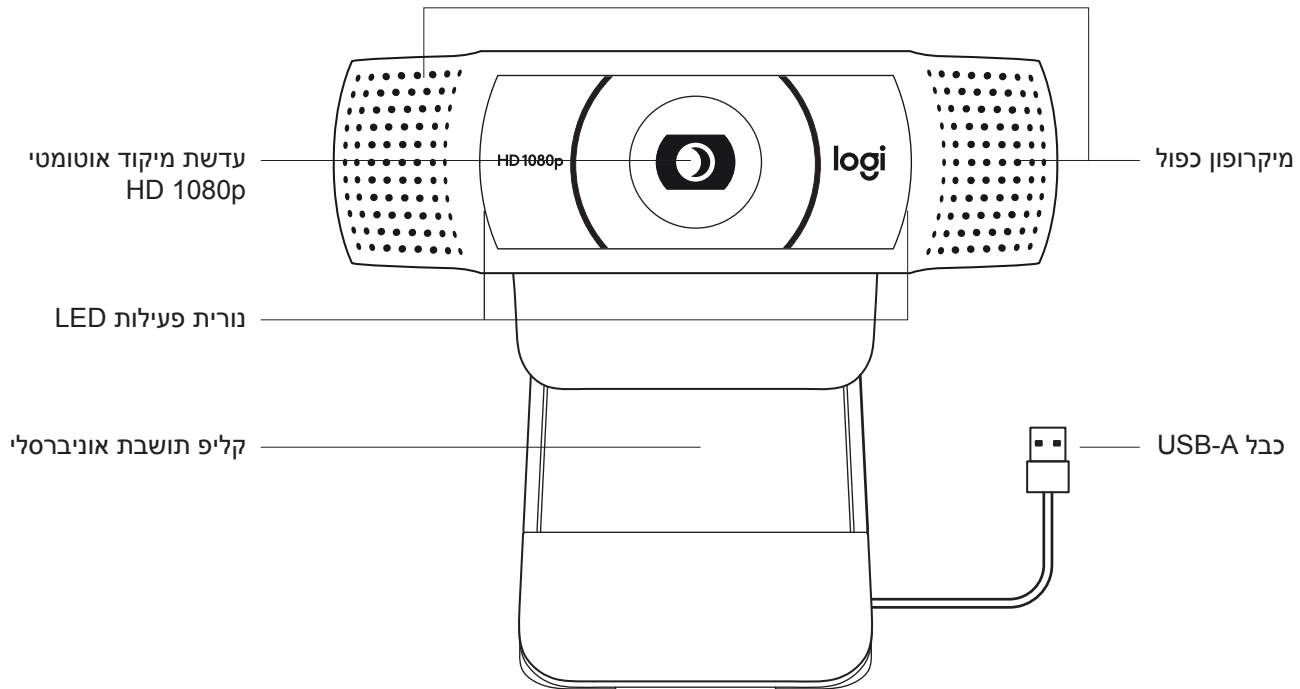

מה בקופסה?

- 1 מצלמת רשת עם כבל USB-A באורך 1.5 מ' מוצרף
- 2 קופון רישיון Xsplit
- 3 תיעוד למשתמש

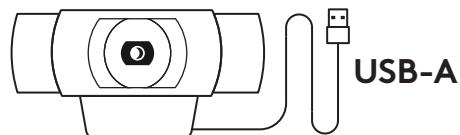

הגדרת מצלמת הרשת

למיקום המצלמה על מסך

1 מקם את מצלמת הרשת על המחשב, המחשב הנייד או המסך במיקום זווית רצויה.



2 כוונן את מצלמת הרשת על מנת לוודא כי רגלית קליפ התושבת האוניברסלי מיושרת עם גב המכשיר.



3 כוונן ידנית את מצלמת הרשת כלפי מעלה/מטה למיקום הטוב ביותר שבו אתה ממוקם בתמונה.

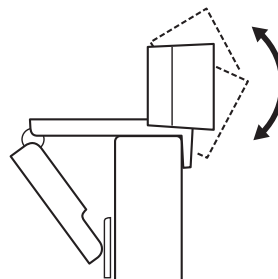

למיקום המצלמה על חצובה*
1 מקם את חיבור חצובת הרבע אינץ' בתחתית קליפ התושבת האוניברסלי.

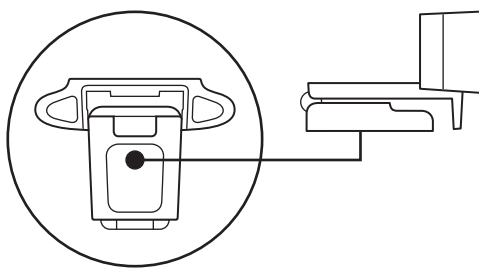

2 אבטח את מצלמת הרשת על החצובה על ידי סיבובה פנימה אל חיבור הרבע אינץ'.

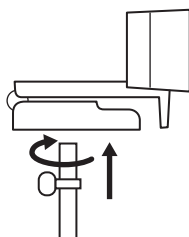

3 מקם את מצלמת הרשת עם החצובה בכל מקום שתרצה למיקום מיטבי על מנת למסגר את עצמך.

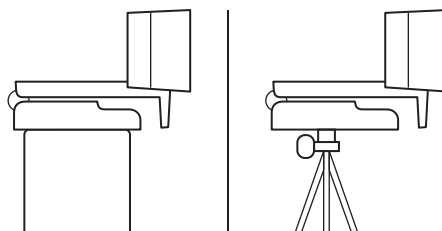

*חצובה אינה כלולה

חיבור המצלמה עם USB-A
חבר את מחבר ה-USB-A אל יציאת USB-A במחשב שלך.

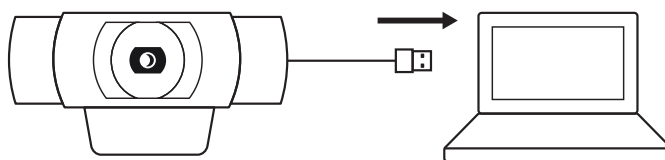

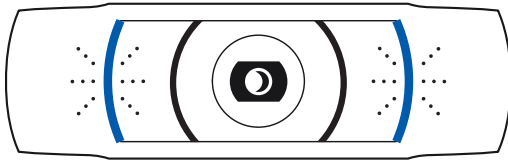

חיבור מוצלח

נורית פעילות LED תאיר כאשר מצלמת הרשת בשימוש על ידי יישום.

מידות

כולל קליפ תושבת קבוע:

גובה x רוחב x עומק:
43.3 מ"מ x 94 מ"מ x 71 מ"מ

אורך כבל: 1.5 מ'

משקל: 162 גר'

www.logitech.com/support/C920X

瞭解您的產品

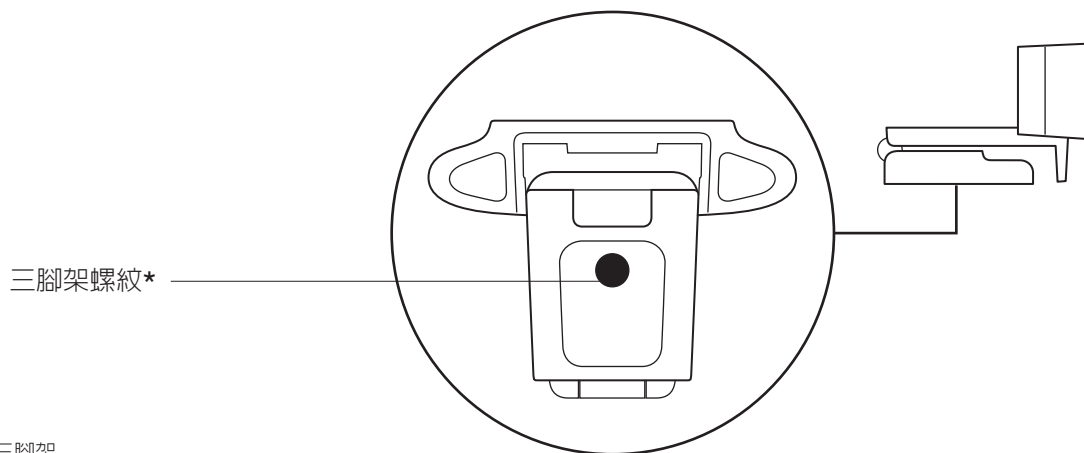
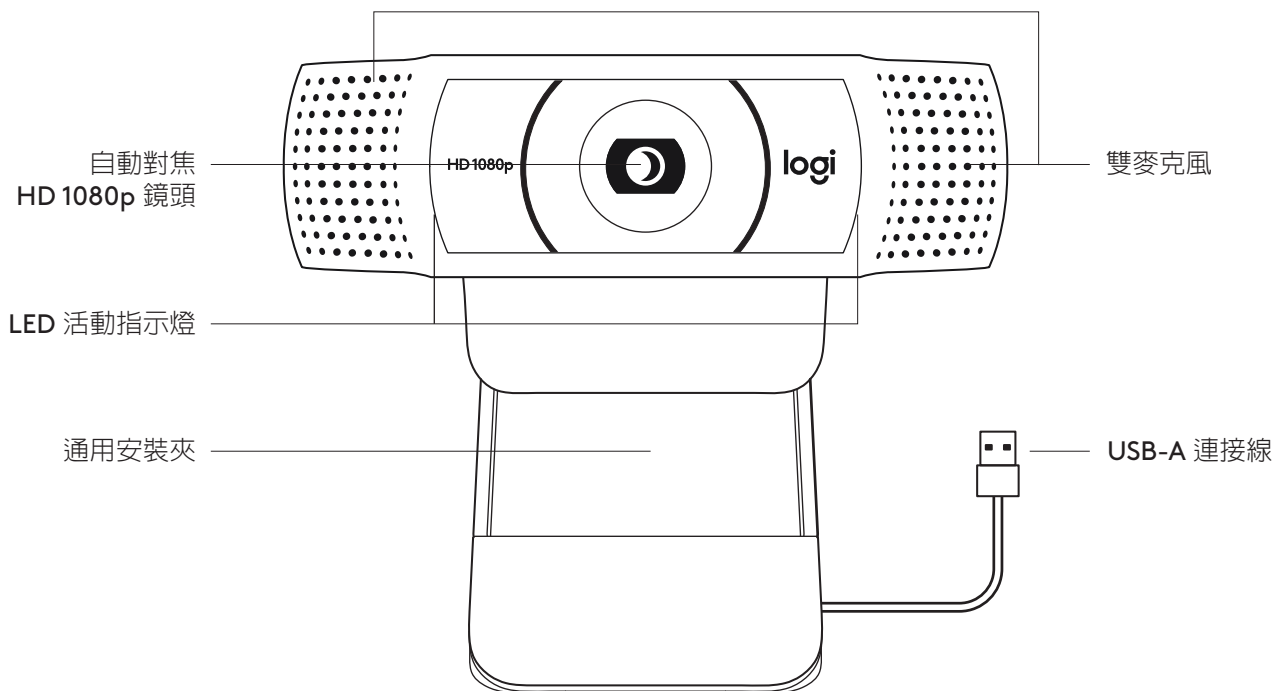

* 未隨附三腳架

包裝內容

- 1 含 1.5 公尺 (5 英尺) USB-A 連接線的網路攝影機
- 2 Xsplit 授權優惠券
- 3 使用者文件

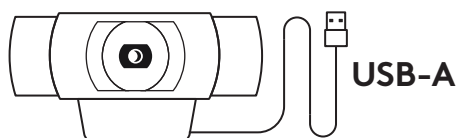

設定網路攝影機

放在螢幕上

- 1 將網路攝影機放到電腦、筆記型電腦或顯示器上您要的位置或角度。

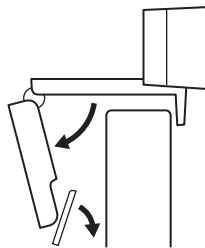

- 2 調整網路攝影機，確認通用安裝夾的腳架與您的裝置背面齊平。

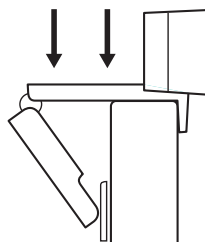

- 3 手動上/下調整網路攝影機，將其調整到對準您取景的最佳位置。

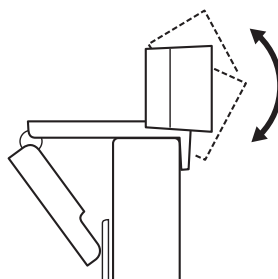

放在三腳架上*

1 找到位於通用安裝夾具底部上的 $\frac{1}{4}$ 英吋三腳架安裝螺紋。

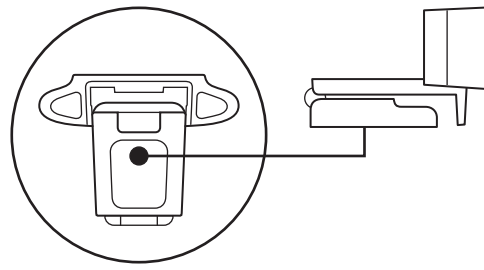

2 將三腳架轉入 $\frac{1}{4}$ 英吋螺紋中，使網路攝影機固定在三腳架上。

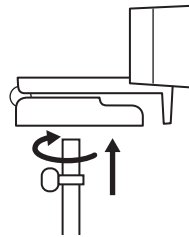

3 將網路攝影機連同三腳架放在您想要的、能夠獲得最佳自拍角度的任何位置。

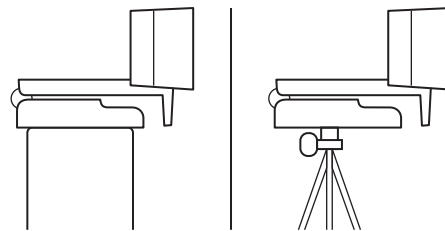

* 未隨附三腳架

透過 **USB-A** 連接網路攝影機

將 **USB-A** 接頭插入您電腦的 **USB-A** 連接埠。

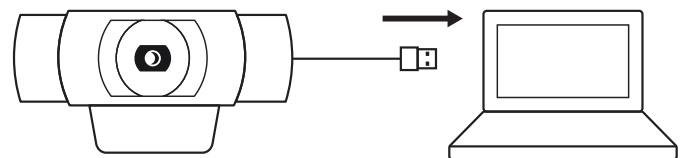

成功連接

LED 活動指示燈會在應用程式使用網路攝影機時亮起。

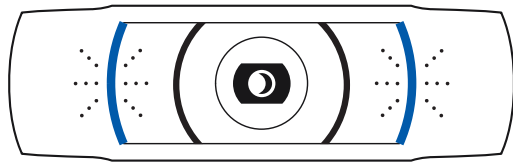

尺寸

包含固定安裝夾：

高 x 寬 x 深：

43.3 公釐 (1.70 英吋) x 94 公釐 (3.70 英吋) x 71 公釐 (2.80 英吋)

連接線長度：1.5 公尺 (5 英呎)

重量：162 公克 (5.71 盎司)

www.logitech.com/support/C920X

제품 설명

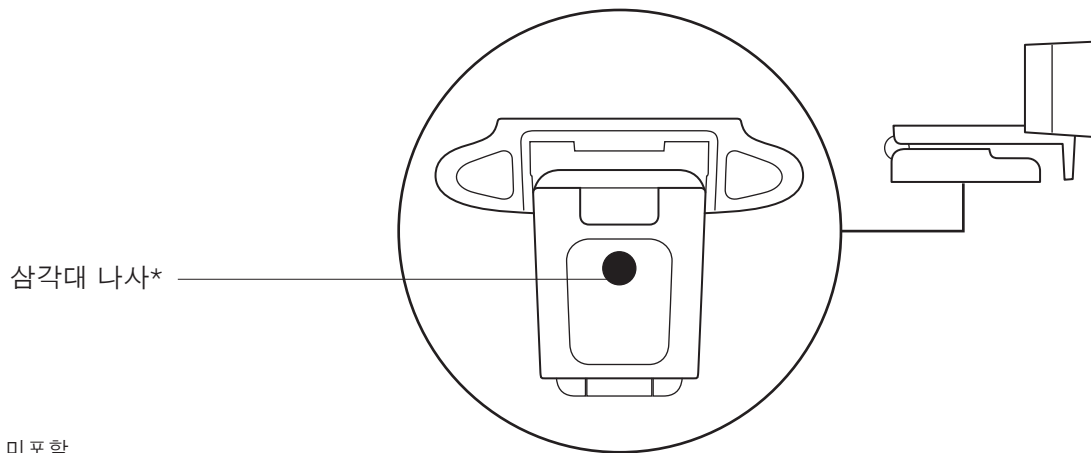
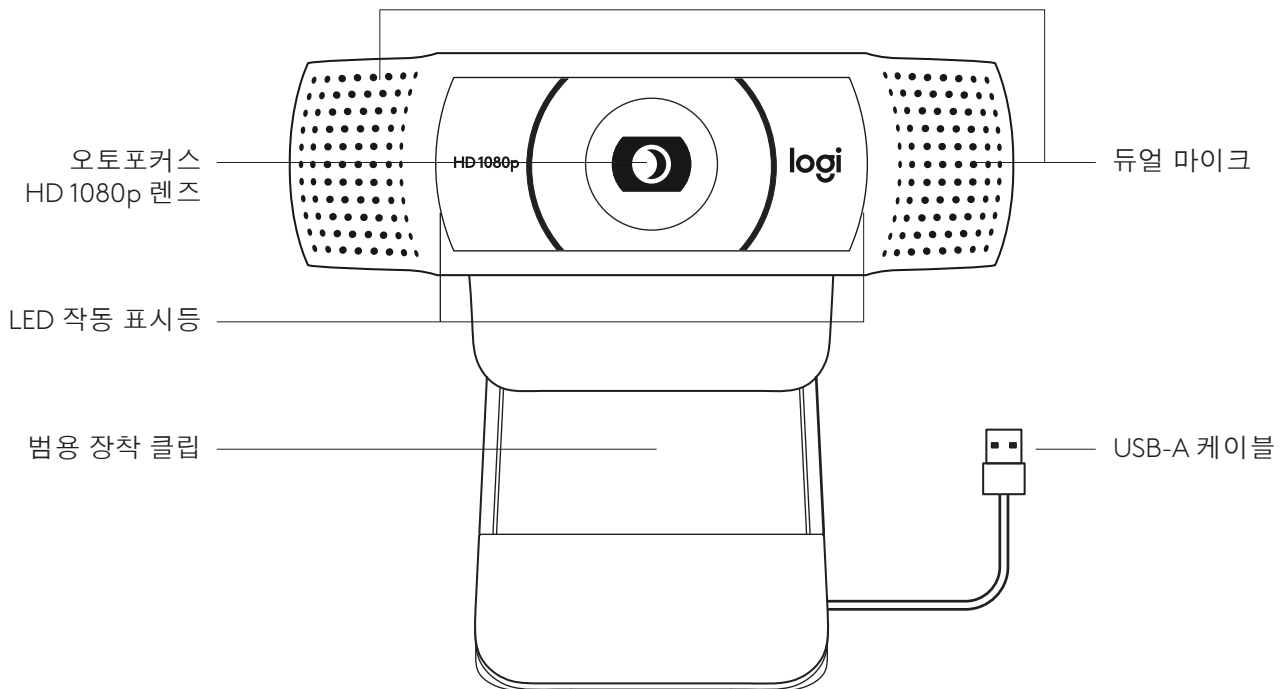

* 삼각대 미포함

박스 내용물

- 1 1.5m(5피트) USB-A 케이블이 부착된 웹캠
- 2 XSplit 라이선스 쿠폰
- 3 웹사용 설명서

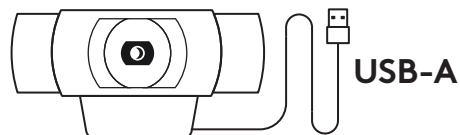

웹캠 설정

모니터에 배치할 경우

- 1 컴퓨터 위, 노트북, 모니터 등 원하는 위치 및 각도에 웹캠을 거치합니다.

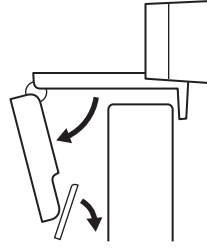

- 2 웹캠을 조절하여 거치할 장치의 후면과 범용 장착 클립의 발이 평행을 이루게 합니다.

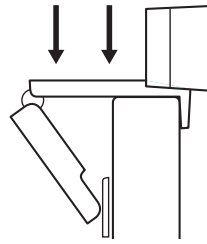

- 3 웹캠을 위아래로 조절하여 최적의 촬영 위치를 찾습니다.

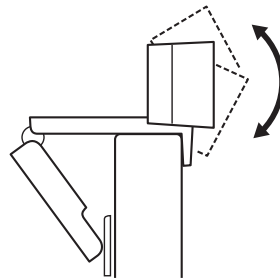

삼각대에 배치할 경우*

1 범용 장착 클립 하단에서 ¼인치 삼각대 나사를 찾습니다.

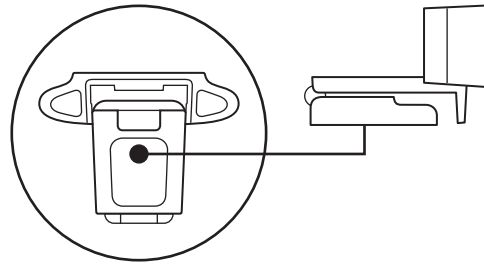

2 웹캠을 ¼인치 나사에 끼워 삼각대에 고정합니다.

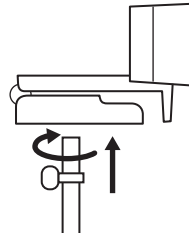

3 삼각대에 장착된 웹캠을 배치하여 최적의 촬영 위치를 찾습니다.

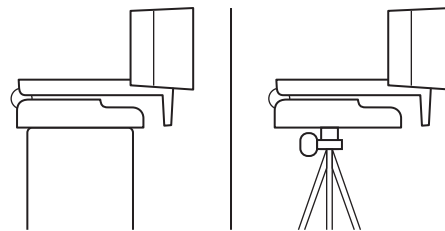

* 삼각대 미포함

USB-A로 웹캠 연결

USB-A 커넥터를 컴퓨터 USB-A 포트에 연결합니다.

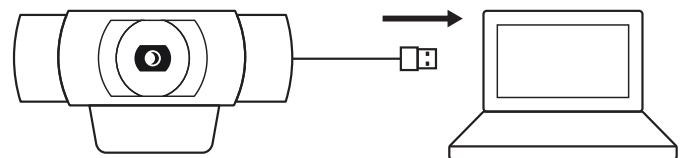

연결 성공

애플리케이션에서 웹캠을 사용하면 LED 작동 표시등에 불이 들어옵니다.

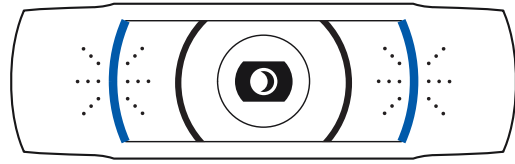

규격

고정 장착 클립 포함

높이 x 너비 x 깊이:

43.3mm(1.70인치) x 94mm(3.70인치) x 71mm(2.80인치)

케이블 길이: 1.5미터 (5피트)

무게: 162g(5.71oz)

www.logitech.com/support/C920X

KENALI PRODUK ANDA

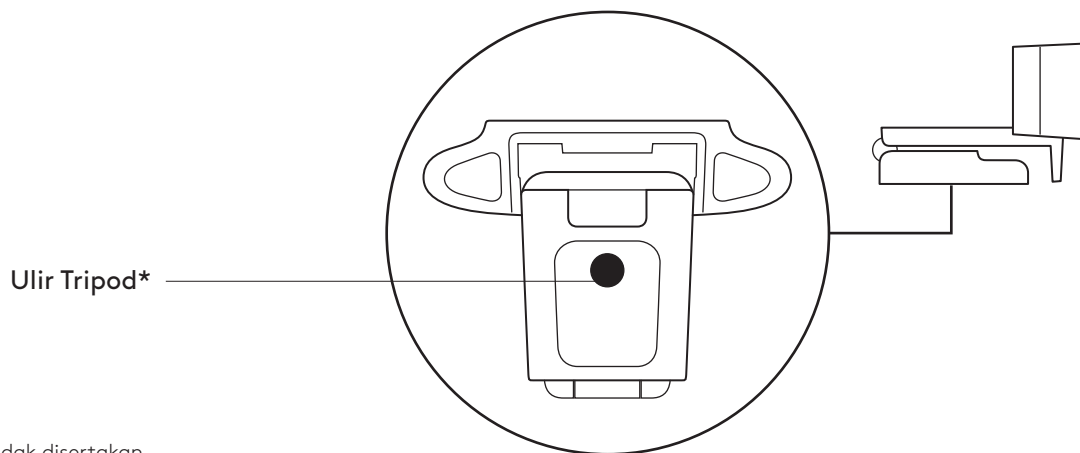
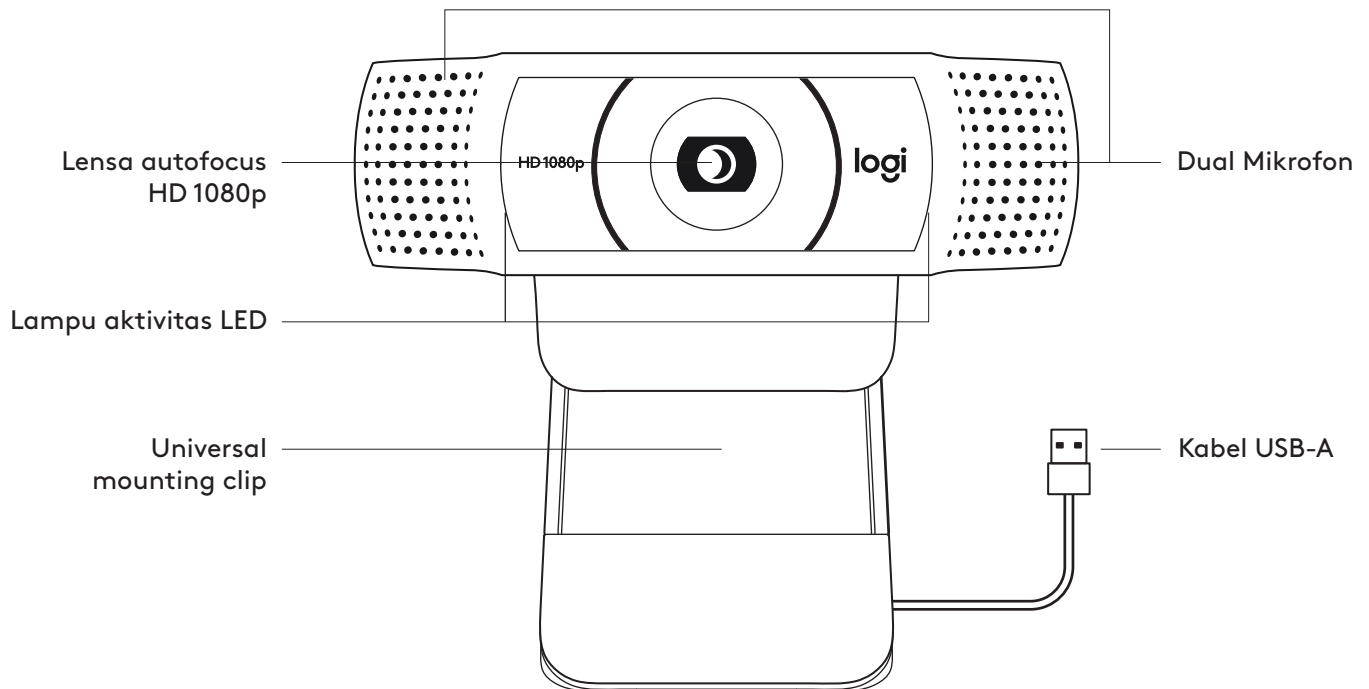

* Tripod tidak disertakan

ISI KEMASAN

- 1 Webcam dengan kabel USB-A 5 kaki (1,5 m) terpasang
- 2 Kupon lisensi XSplit
- 3 Dokumentasi pengguna

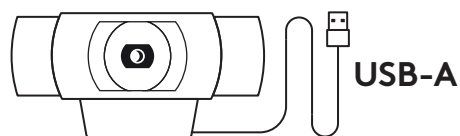

MEMASANG WEBCAM

Untuk penempatan di atas layar

- 1 Letakkan webcam Anda di komputer, laptop, atau layar pada posisi atau sudut yang Anda inginkan.



- 2 Sesuaikan webcam untuk memastikan kaki universal mounting clip terpasang erat dengan bagian belakang perangkat Anda.

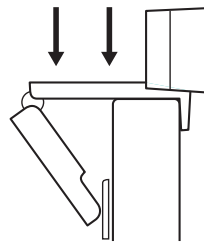

- 3 Gerakkan webcam ke atas/ke bawah ke posisi terbaik agar bisa menangkap diri Anda.

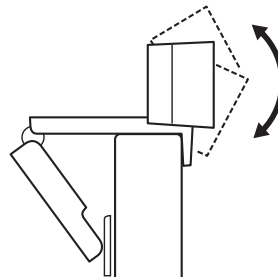

Untuk penempatan di atas tripod*

- 1 Cari ulir tripod ¼ inci di bagian bawah universal mounting clip.

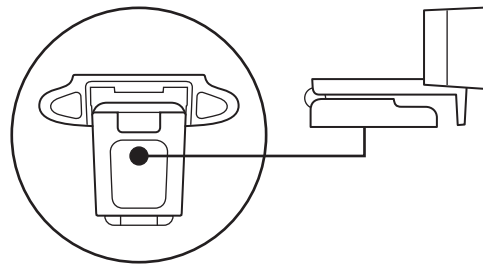

- 2 Pasangkan webcam di tripod Anda dengan memutarinya pada ulir ¼ inci.

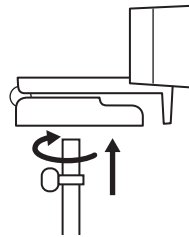

- 3 Letakkan webcam yang telah terpasang di tripod di mana pun yang Anda inginkan agar mendapatkan posisi terbaik untuk menyorot diri Anda.

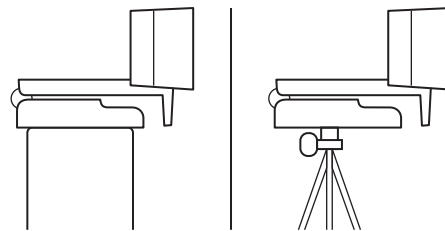

* Tripod tidak disertakan

MENGHUBUNGKAN WEBCAM VIA USB-A

Pasangkan konektor USB-A ke port USB-A di komputer Anda.

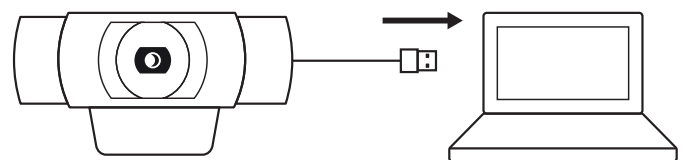

KONEKSI BERHASIL

Lampu aktivitas LED akan menyala ketika webcam digunakan oleh sebuah aplikasi.

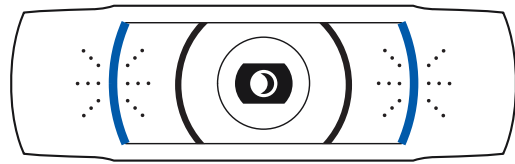

DIMENSI

TERMASUK FIXED MOUNTING CLIP:

Tinggi x Lebar x Tebal:

1,70 inci (43,3 mm) x 3,70 inci (94 mm) x 2,80 inci (71 mm)

Panjang Kabel: 5 kaki (1,5 inci)

Berat: 5,71 oz (162 g)

www.logitech.com/support/C920X